

**MOLECULAR EPIDEMIOLOGY AND  
MOLECULAR MECHANISMS OF  
ANTIMICROBIAL RESISTANCE  
IN *NEISSERIA GONORRHOEAE*  
IN CHINA: IMPLICATIONS FOR  
DISEASE CONTROL**

A Thesis Submitted to the College of Graduate Studies and Research  
in partial fulfillment of the requirements for the Degree of Doctor of Philosophy  
in the Department of Microbiology and Immunology  
University of Saskatchewan  
Saskatoon

By  
Mingmin Liao

## **PERMISSION TO USE**

In presenting this thesis in partial fulfillment of the requirements for a Postgraduate degree from the University of Saskatchewan, I agree that the Libraries of this University may make it freely available for inspection. I further agree that permission for copying of this thesis in any manner, in whole or in part, for scholarly purposes may be granted by the professor or professors who supervised my thesis work or, in their absence, by the Head of the Department or the Dean of the College in which my thesis work was done. It is understood that any copying or publication or use of this thesis or parts thereof for financial gain shall not be allowed without my written permission. It is also understood that due recognition shall be given to me and to the University of Saskatchewan in any scholarly use which may be made of any material in my thesis.

Requests for permission to copy or to make other use of material in this thesis in whole or part should be addressed to:

Head of the Department of Microbiology and Immunology  
University of Saskatchewan  
Health Science Building  
107 Wiggins Road  
Saskatoon, Saskatchewan, Canada S7N 5E5

## ABSTRACT

Gonorrhea, caused by the human pathogen *Neisseria gonorrhoeae*, is a severe public health problem worldwide with more than 82 million new infections each year. *N. gonorrhoeae* is transmitted by sexual contact and primarily causes urogenital mucosal infections in men and women. Left untreated, this infection may cause severe complications, especially in females. Eye infections of the newborn can occur. Gonorrhea infections enhance HIV transmission. The highly prevalent antibiotic resistance and the emergence of new drug resistances render treatment of the infections increasingly difficult. Close monitoring of antimicrobial susceptibility of this pathogen is crucial, and enhanced knowledge of molecular mechanisms of gonococcal antimicrobial resistance is urgently needed. There are no vaccines available against *N. gonorrhoeae*. Control of gonorrhea relies on comprehensive strategies which can be better formulated by understanding, at molecular levels, how *N. gonorrhoeae* is transmitted in communities.

My research aimed to illustrate the severe burden of antimicrobial resistance in *N. gonorrhoeae* temporally and geographically in China and to reveal the molecular mechanisms of antibiotic resistance particularly the development of reduced susceptibility to ceftriaxone in *N. gonorrhoeae* isolates. To determine specific strain distributions, *N. gonorrhoeae* isolates were characterized using molecular typing methods such as a modified *porB*-based typing scheme and the *N. gonorrhoeae* Multi-Antigen Typing (NG-MAST) method, compared to traditional epidemiological approaches. The ultimate goal was to provide information for better formulating disease control strategies for gonorrhea.

In this research, male patients with gonorrhea and their sex partners were recruited in Shanghai (2005 and 2008) and in Urumchi (2007-2008), China. Epidemiological information pertaining to sexual contacts was collected. *N. gonorrhoeae* isolates were investigated for their antimicrobial susceptibility. Molecular mechanisms of antimicrobial resistance were explored by analysis of potential resistant determinants (*gyrA*, *parC*, *porB*, *mtrR*, *ponA* and *penA*). The molecular data were combined with bioinformatic analysis and traditional epidemiological data.

High percentages of *N. gonorrhoeae* isolates (11% - 19% in Shanghai, 4.5% in Urumchi) exhibited reduced susceptibility to ceftriaxone (MICs = 0.125-0.25 mg/L), the first line drug recommended for the treatment of gonorrhea in China. The majority of isolates (>98%) were susceptible to spectinomycin, an alternative regimen for gonorrhea treatment; however, the proportion of isolates having intermediate levels of susceptibility increased from 1.9% in 2005 to 9.9% in 2008. The majority of isolates tested were resistant to penicillin (80% - 93%), tetracycline (56% - 65%) and ciprofloxacin (98% - 100%). Plasmid-mediated resistance in *N. gonorrhoeae* isolates were highly prevalent (51% - 79%) in Shanghai and Urumchi.

Analysis of 60 clinical isolates revealed that reduced susceptibility to ceftriaxone is mediated by *porB*1b allele and is associated with specific mutations in penicillin binding protein 2 and in the DNA binding and dimerization domains of MtrR. Penicillin binding protein 1 is not involved in reduced susceptibility to ceftriaxone. Although mutation patterns in quinolone resistant determinant regions (QRDRs) varied, the majority of ciprofloxacin resistant isolates had double mutations in GyrA (S91F and D95G/A/N) and most isolates also carried a S87R/N mutation in ParC. The presence of mutations in the QRDR of ParC is correlated with elevated ciprofloxacin MICs.

A modified *porB*-based molecular typing scheme was developed and involved ~82% of the DNA sequence of gonococcal *porB*. This typing method proved to have high discriminatory ability (index of discrimination = 0.93 – 0.96), and was cost effective and easy to perform as compared to the NG-MAST analysis. Using the modified *porB*-based typing method, *N. gonorrhoeae* isolates were reliably differentiated, and transmission clusters were identified. Molecular epidemiology using the *porB*-based method confirmed direct sexual connections and identified sexual networks otherwise unrevealed by the patient self-reporting or traditional case-tracing methods.

**Key words:** *Neisseria gonorrhoeae*, antimicrobial susceptibility/resistance, molecular determinants of antimicrobial resistance, molecular epidemiology, molecular typing, strain transmission, sexual networks

## ACKNOWLEDGEMENTS

First and foremost, I would like to thank Dr. Jo-Anne R. Dillon, for giving me opportunities to study and work in her laboratory. It is a great pleasure for me to have had the opportunity to work with Dr. Dillon since 2003, both at the University of Ottawa and the University of Saskatchewan. I am grateful that Dr. Dillon encouraged me to complete PhD studies with her in early 2007, after her laboratory moved to the University of Saskatchewan in 2004. I also thank Dr. Dillon for the many other aspects which would build a basis necessary for my career. I thank her for making time for me whenever I needed it, despite her hectic schedule as the Dean of Arts and Science at the University of Saskatchewan.

To my advisory committee, Dr. Joseph Blondeau, Dr. Hughes Goldie, Dr. Peter Howard and Dr. Bruce Reeder, I wish to express my gratitude for your guidance in helping me strengthen my project. I would also like to thank Dr. Allen Ross, a former member of my advisory committee (Currently at the Griffith University, Australia).

In particular, I would like to thank Dr. Weiming Gu and his staff at the Shanghai Skin Disease and STD Hospital (SSDSH), Shanghai, China. Without Dr. Gu's and his colleagues' support and kindness, my PhD research would not have succeeded. The field work for this thesis was conducted at the SSDSH. Dr. Gu, Dr. Yang Yang, Dr. Lei Wu and Dr. Chuguang Zhang recruited the study subjects and collected, isolated and confirmed *Neisseria gonorrhoeae* isolates. Dr. Yang performed the antimicrobial susceptibility tests of *N. gonorrhoeae* isolates, and extracted and shipped the bacterial chromosomal DNA samples for molecular analysis. Yang, I have great memories when you worked in Dr. Dillon's laboratory in 2005 to study the various methods we would use for this research.

All members of Dr. Dillon's laboratory have supported me during my work and study in Saskatoon and in Ottawa. Dr. Sandra Ramirez-Arcos helped and supported me to establish my career in Dr. Dillon's Laboratory. Dr. Nelson Eng was the other Dillon lab member from Ottawa to move with me and my family to Saskatoon. He made me less lonely in a new environment, and together we settled on the second floor lab at the Vaccine and Infectious Disease Organization (VIDO) in 2004. To Kelli, the first to enter the new Dillon lab at the University of Saskatchewan, and to Cherise, the first new graduate student Dr. Dillon recruited in Saskatoon, thank you for your friendship and for showing me what Saskatoon has to offer to newcomers. To

Sarah Helgeson and Wenkai Fu, many thanks for your assistance in analyzing DNA sequences. To the other former lab crew, Monique, Monica, Debu, Kirsten, Silva, Swati, Jesse, Jenni, Sarah, Shanna, Wenkai, Qingyang and Fei, many thanks for your support and for being great lab members. Of course I have not forgotten our current crew after the above long list. To Rajinder, Sinisa, Stefania, Asghar, Yan, Ava, Helena, Sidharath, Guanqun, Molly and Martha, I am not sure what I would have done without your support in the lab- thanks for all the good times in the lab. Martha, you are a great friend and co-worker – I will also remember our work for the Gonococcal Antimicrobial Susceptibility Surveillance Program in Latin America (GASP-LAC) and the Caribbean, and our happy trip in Buenos Aires, Argentina, in November 2010.

I am very grateful to VIDO for giving me the opportunity to work and study in an excellent environment and world-class facility for research in infectious diseases. I remember Dr. Andrew Potter toured me around Saskatoon, the University and VIDO when I first visited in June 2004 before moving.

I would also like to thank staff at the Graduate Office of the Department of Microbiology and Immunology for your kind support and administration during the period of my study. Thanks also go to the staff of the Dean's Office of the College of Arts and Science for their support.

I am very grateful to the Canadian Institutes of Health Research (CIHR) for financially supporting my graduate program. I would like to sincerely thank the entire research team for letting me become a team member and for supporting my thesis studies. Dr. Ann Jolly (Public Health Agency of Canada) and Dr. Yue Chen (University of Ottawa), thank you for your support and guidance. I would like to thank the Ethics Board of the University of Saskatchewan for issuing ethics approval for my PhD project, in conjunctions with the ethics approval from Boards of the Shanghai Municipal Bureau of Public Health and the Ottawa Hospitals.

Finally, a special and huge thank you to my wife Kristi and my daughter Jessica. Kristi is always there for me - whenever I am happy, unhappy, or so so. To my daughter Jessica, we were talking about who graduates first. Thank you for your understanding, although you have no idea about what I have been doing in research and although your many “whatevers” bother me.

Thank you all and best wishes,

Mingmin

## TABLE OF CONTENTS

PERMISSION TO USE.....	i
ABSTRACT.....	ii
ACKNOWLEDGEMENTS.....	iv
TABLE OF CONTENTS.....	vi
LIST OF TABLES.....	x
LIST OF FIGURES.....	xi
LIST OF ABBREVIATIONS.....	xiii
1. INTRODUCTION.....	1
1.1 Epidemiology and Clinical Features of Gonorrhoea.....	2
1.1.1 Prevalence of Gonorrhoea in China and North America.....	2
1.1.2 Transmission of Gonorrhoea.....	7
1.1.3 Clinical Manifestations and Complications of Gonorrhoea.....	10
1.1.4 Relevant Pathophysiology of <i>Neisseria gonorrhoeae</i> .....	12
1.2 Antimicrobial Resistance in <i>Neisseria gonorrhoeae</i> and Treatment of Gonorrhoea.....	17
1.2.1 Recommendations for the Treatment of Gonorrhoea.....	19
1.2.2 Prevalence of Antimicrobial Resistance in <i>N. gonorrhoeae</i> in China and Canada.....	22
1.3 Modes of Action and Mechanisms of Antimicrobial Resistance in <i>Neisseria gonorrhoeae</i> .....	29
1.3.1 $\beta$ -lactams: Penicillin and Cephalosporins.....	30
1.3.2 Quinolones.....	37
1.3.3 Macrolides: Erythromycin and Azithromycin.....	40
1.3.4 Tetracycline.....	42
1.3.5 Spectinomycin.....	42
1.4 Molecular Typing and Molecular Epidemiology in <i>Neisseria gonorrhoeae</i> .....	44
1.4.1 Overview of Molecular Typing Methods for <i>N. gonorrhoeae</i> .....	44
1.4.2 Molecular Epidemiology of Gonorrhoea.....	56
1.5 Hypothesis and Objectives.....	58
2. METHODOLOGY.....	60
2.1 Epidemiological Design.....	62

2.1.1	Study Sites.....	62
2.1.2	Patient Recruitment and Collection of Epidemiological Information.....	62
2.2	Collection, Isolation, Identification and Storage of <i>Neisseria gonorrhoeae</i>	
	Isolates.....	63
2.3	Antimicrobial Susceptibility Testing of <i>Neisseria gonorrhoeae</i> Isolates.....	64
2.3.1	Determination of Minimal Inhibitory Concentrations.....	64
2.3.2	Determination of Plasmid-mediated Resistance.....	66
2.3.3	Interpretation Criteria for Resistance Phenotypes.....	66
2.4	Chromosomal DNA Isolation from <i>Neisseria gonorrhoeae</i> Isolates.....	67
2.5	Polymerase Chain Reactions and DNA Sequencing Analysis.....	68
2.5.1	Primers.....	68
2.5.2	Polymerase Chain Reactions.....	70
2.5.3	DNA Sequencing.....	70
2.5.4	DNA Sequence Verification and Editing.....	70
2.6	Molecular Mechanisms of Antimicrobial Resistance in <i>Neisseria gonorrhoeae</i> .....	73
2.6.1	Plasmid Typing of $\beta$ -lactamase Producing and <i>tetM</i> -containing Plasmids.....	73
2.6.2	Analysis of Antimicrobial Resistance Determinants in <i>N. gonorrhoeae</i> Isolates...73	
2.7	Phylogenetic Analysis of <i>Neisseria gonorrhoeae porB</i> .....	74
2.8	<i>Neisseria gonorrhoeae</i> Multi-Antigen Sequence Typing (NG-MAST).....	75
2.9	Concordance between Sexual Networks Established from Epidemiological	
	Information and Revealed by <i>porB</i> -based Molecular Typing.....	76
2.10	Statistical Analysis.....	76
2.11	DNA Sequence Deposit.....	77
3	RESULTS.....	78
3.1	Antimicrobial Resistance in <i>Neisseria gonorrhoeae</i> in Shanghai and Urumchi.....	79
3.1.1	Antimicrobial Resistance of 159 <i>N. gonorrhoeae</i> Isolates from Shanghai in	
	2005.....	79
3.1.2	Antimicrobial Resistance of 71 <i>N. gonorrhoeae</i> Isolates from Shanghai in	
	2008.....	82
3.1.3	Antimicrobial Resistance of 44 <i>N. gonorrhoeae</i> Isolates from Urumchi.....	84
3.1.4	Temporal Distribution of Antimicrobial Resistance of <i>N. gonorrhoeae</i>	



Isolates in Shanghai: 2005/2008.....	86
3.1.5 Geographic Distribution of Antimicrobial Resistance of <i>N. gonorrhoeae</i>	
Isolates: Shanghai/Urumchi.....	89
3.1.6 Analysis of Gonococcal $\beta$ -lactamase-producing and <i>tetM</i> -containing Plasmids.....	92
3.2 Molecular Mechanisms of Antimicrobial Resistance in <i>Neisseria gonorrhoeae</i> .....	94
3.2.1 Gonococcal PorB Is Associated with Penicillin and Tetracycline Resistance.....	94
3.2.2 Association between Mutations in Multiple Loci and Reduced Susceptibility to Ceftriaxone in <i>N. gonorrhoeae</i> Isolates.....	98
3.2.3 Analysis of Quinolone Resistant Determinant Regions in <i>N. gonorrhoeae</i> .....	108
3.3 Molecular Epidemiology of <i>Neisseria gonorrhoeae</i> in China.....	113
3.3.1 Phylogenetic Analysis of <i>N. gonorrhoeae</i> Isolates Based on <i>porB</i> DNA Sequences.....	113
3.3.2 NG-MAST Analysis of <i>N. gonorrhoeae</i> Isolates.....	129
3.3.3 Comparison of the Modified <i>porB</i> -based and NG-MAST Analysis in Differentiating <i>N. gonorrhoeae</i> Isolates.....	130
3.3.4 Summary of the Modified <i>porB</i> -based Typing Scheme and NG-MAST Analysis for Typing <i>N. gonorrhoeae</i> Isolates.....	132
3.3.5 Concordance between Patient-reported Sexual Contacts and <i>porB</i> Genotypes ...	135
4 DISCUSSION.....	138
4.1 Prevalence of Antimicrobial Resistance in <i>Neisseria gonorrhoeae</i> .....	139
4.1.1 Prevalence of Reduced Susceptibility to Third-generation Cephalosporins in <i>N. gonorrhoeae</i> .....	139
4.1.2 Susceptibility of <i>N. gonorrhoeae</i> Isolates to Spectinomycin.....	142
4.1.3 <i>N. gonorrhoeae</i> Isolates Are Resistant to Quinolones.....	143
4.1.4 <i>N. gonorrhoeae</i> Isolates Are Resistant to Penicillin and Tetracycline.....	145
4.1.5 Plasmid-mediated Antimicrobial Resistance in <i>N. gonorrhoeae</i> .....	147
4.1.6 Conclusion.....	150
4.2 Molecular Mechanisms of Antimicrobial Resistance in <i>Neisseria gonorrhoeae</i> .....	151
4.2.1 Mechanisms of Reduced Susceptibility to Ceftriaxone in <i>N. gonorrhoeae</i> .....	151
4.2.2 Role of PorB in Chromosomal Resistance to Penicillin or Tetracycline Resistance in <i>N. gonorrhoeae</i> .....	154

4.2.3	Mechanisms of Quinolone Resistance in <i>N. gonorrhoeae</i> .....	155
4.2.4	Conclusion.....	157
4.3	Molecular Epidemiology of <i>Neisseria gonorrhoeae</i> in China.....	158
4.3.1	porB-based DNA Sequence Analysis Is a Useful Tool for Molecular Epidemiological Studies in <i>N. gonorrhoeae</i> .....	158
4.3.2	Construction of Gonorrhea Transmission Networks in Shanghai Using a Modified porB-based Typing Method.....	161
4.3.3	Strain Diversity of <i>N. gonorrhoeae</i> Revealed by porB-based Sequence Analysis.....	162
4.3.4	Temporal Strain Distributions of <i>N. gonorrhoeae</i> in Shanghai.....	163
4.3.5	Spatial Strain Distribution of <i>N. gonorrhoeae</i> .....	165
4.3.6	Conclusion.....	165
5	CONCLUDING REMARKS.....	167
6	REFERENCES.....	171
	APPENDIX.....	198
A1	Questionnaire for Patient Recruitment (Male Index Patients).....	199
A2	Citation Approvals.....	211
A2.1	World Health Organization Press (Permissions Management) .....	211
A2.2	Annals of Internal Medicine.....	212
A2.3	Oxford University Press (Yang et al 2006, J Antimicrob Chemother).....	213
A2.4	Oxford University Press (Liao et al 2008, J Antimicrob Chemother).....	214
A2.5	Oxford University Press (Liao et al 2011, J Antimicrob Chemother).....	215
A2.6	American Society of Microbiology (Liao et al 2009, J Clin Microbiol).....	216
A3	Mingmin Liao Curriculum Vitae .....	217

## LIST OF TABLES

Table 1.1	Current recommendations of first line antibiotics for the treatment of uncomplicated gonorrhoea.....	21
Table 1.2	Characteristics of typing methods used in differentiating <i>N. gonorrhoeae</i> isolates..	45
Table 1.3	Current genome sequencing projects in <i>N. gonorrhoeae</i> .....	54
Table 2.1	Determination of minimal inhibitory concentrations and interpretation criteria for <i>N. gonorrhoeae</i> .....	65
Table 2.2	Primers used for PCR and DNA sequencing reactions.....	69
Table 2.3	Reference DNA sequences used in this study.....	72
Table 3.1	MICs of 159 <i>N. gonorrhoeae</i> isolates from Shanghai 2005 to 5 antimicrobial agents.....	81
Table 3.2	MICs of 71 <i>N. gonorrhoeae</i> isolates from Shanghai in 2008 to 5 antimicrobial agents.....	83
Table 3.3	MICs of 44 <i>N. gonorrhoeae</i> isolates from Urumchi 2008 to 5 antimicrobial agents.....	85
Table 3.4	Mutations at the residues G120 and A121 of <i>porB</i> in 143 <i>N. gonorrhoeae</i> isolates from Shanghai in 2005.....	97
Table 3.5	Association between gonococcal PorB and reduced susceptibility to ceftriaxone in <i>N. gonorrhoeae</i> isolates.....	99
Table 3.6	Specific amino acid substitutions in <i>N. gonorrhoeae</i> MtrR are associated with reduced susceptibility of gonococcal isolates to ceftriaxone.....	100
Table 3.7	Mutation patterns of gonococcal penicillin binding protein 2.....	105
Table 3.8	QRDR mutation patterns in 103 <i>N. gonorrhoeae</i> isolates.....	109
Table 3.9	<i>porB</i> -based clustering of 174 <i>N. gonorrhoeae</i> isolates from Shanghai in 2005.....	115
Table 3.10	<i>porB</i> -based clustering of 81 <i>N. gonorrhoeae</i> isolates from Shanghai in 2008.....	119
Table 3.11	<i>porB</i> -based clustering of 44 <i>N. gonorrhoeae</i> isolates from Urumchi in 2007-2008.....	122
Table 3.12	Distribution of <i>porB</i> DNA sequences and NG-MAST sequence types (STs) in 199 <i>N. gonorrhoeae</i> isolates from Shanghai in 2005.....	133
Table 3.13	Index of Discrimination of the modified <i>porB</i> -based typing scheme and NG-MAST analysis for differentiating <i>N. gonorrhoeae</i> isolates.....	134

## LIST OF FIGURES

### CHAPTER 1

Fig. 1.1	Prevalence of gonorrhoea in China.....	4
Fig. 1.2	Distribution of sexually transmitted infections (STIs) in China in 2005.....	6
Fig. 1.3	Transmission dynamics of sexually transmitted infections at the population levels..	9
Fig. 1.4	Gram-stain and microscopy of <i>N. gonorrhoeae</i> .....	13
Fig. 1.5	Schematic Presentation of <i>N. gonorrhoeae</i> PorB.....	15
Fig. 1.6	Historical perspective on antimicrobial resistance in <i>N. gonorrhoeae</i> in the United States.....	18
Fig. 1.7	Trends of penicillin resistance in <i>N. gonorrhoeae</i> .....	25
Fig. 1.8	Trends of tetracycline resistance in <i>N. gonorrhoeae</i> .....	26
Fig. 1.9	Trends of ciprofloxacin resistance in <i>N. gonorrhoeae</i> .....	27
Fig. 1.10	Trends of PPNG and TRNG in China.....	28
Fig. 1.11	Structure of $\beta$ -lactam antibiotics - penicillin and third-generation cephalosporins used for the treatment of gonorrhoea.....	31
Fig. 1.12	Schematic presentation of antimicrobial resistance determinants in <i>N. gonorrhoeae</i> .....	34
Fig. 1.13	Structure of quinolone antibiotics.....	38
Fig. 1.14	Schematic presentation of quinolone resistance determinant regions (QRDRs) in GyrA and ParC in <i>N. gonorrhoeae</i> .....	39
Fig. 1.15	Structure of erythromycin and azithromycin.....	41
Fig. 1.16	Structure of tetracyclines, doxycycline and spectinomycin.....	43

### CHAPTER 2

Fig. 2.1	Overview of methods.....	61
----------	--------------------------	----

### CHAPTER 3

Fig. 3.1	Comparison of antimicrobial resistance of <i>N. gonorrhoeae</i> isolates from Shanghai: 2005/2008.....	87
----------	---	----

Fig. 3.2	MIC distribution of <i>N. gonorrhoeae</i> isolates for ciprofloxacin, spectinomycin and ceftriaxone.....	88
Fig. 3.3	Comparison of antimicrobial resistance of <i>N. gonorrhoeae</i> isolates from Shanghai and Urumchi (2008).....	90
Fig. 3.4	MIC distribution of <i>N. gonorrhoeae</i> isolates for ciprofloxacin, spectinomycin and ceftriaxone in Shanghai and Urumchi.....	91
Fig. 3.5	Differentiation of $\beta$ -lactamase producing plasmids in PPNG <i>N. gonorrhoeae</i> isolates.....	93
Fig. 3.6	Antimicrobial susceptibility and <i>porB</i> genotypes of 143 <i>N. gonorrhoeae</i> isolates from male patients.....	95
Fig. 3.7	Amino acid mutations in the transpeptidase domain of gonococcal PBP2.....	104
Fig. 3.8	Clonality analysis of <i>N. gonorrhoeae</i> isolates with reduced susceptibility to ceftriaxone.....	107
Fig. 3.9	Correlation of Ciprofloxacin MICs and Mutations of QRDRs in <i>N. gonorrhoeae</i> Isolates.....	111
Fig. 3.10	Trends of QRDR mutations in ciprofloxacin resistant <i>N. gonorrhoeae</i> isolates in Shanghai: 2005/2008.....	112
Fig. 3.11	<i>porB</i> -based phylogenetic analysis of 174 <i>N. gonorrhoeae</i> isolates from Shanghai in 2005.....	116
Fig. 3.12	<i>porB</i> -based phylogenetic analysis of 81 <i>N. gonorrhoeae</i> isolates from Shanghai in 2008.....	120
Fig. 3.13	<i>porB</i> -based phylogenetic analysis of 44 <i>N. gonorrhoeae</i> isolates from Urumchi in 2007-2008.....	123
Fig. 3.14	Temporal strain distribution of <i>N. gonorrhoeae</i> in Shanghai based on <i>porB</i> DNA sequences: 2005/2008.....	125
Fig. 3.15	Spatial strain distribution of <i>N. gonorrhoeae</i> based on <i>porB</i> DNA sequences: Shanghai/Urumchi.....	128
Fig. 3.16	<i>porB</i> -based groups of 199 <i>N. gonorrhoeae</i> isolates.....	131
Fig. 3.17	Sexual networks identified by the modified <i>porB</i> -based typing scheme.....	137

## LIST OF ABBREVIATIONS

A	Auxotyping
AA	Amino acid
AMR	Antimicrobial resistance
AUH	Arginine-hypoxanthine-uracil-requiring phenotype
CDC	Centers for Disease Control and Prevention, the United States
CIP	Ciprofloxacin
CLSI	Clinical and Laboratory Standards Institute
CMR	Chromosomally-mediated resistance
CRO	Ceftriaxone
CRO <sup>Red</sup>	Reduced susceptibility to ceftriaxone
CRO <sup>S</sup>	Susceptible to ceftriaxone
DG	Disseminated gonorrhoea
ESSTI	European Surveillance of Sexually Transmitted Infections
GASP	Gonococcal antimicrobial susceptibility surveillance program
GISP	Gonococcal Isolate Surveillance Project (the United States)
GyrA	DNA gyrase
HIV	Human immunodeficiency virus
HPA	Health Protection Agency, United Kingdom
ID	Index of discrimination
LOS	Lipo-oligosaccharide
MAb	Monoclonal antibody
MDa	Megadalton
MDR	Multiple drug resistance
MIC	Minimal inhibitory concentration
MLEE	Multiple locus enzyme electrophoresis
MLST	Multilocus sequence typing
MtrR	Multiple transferable resistance repressor
NG-MAST	<i>Neisseria gonorrhoeae</i> multi-antigen sequence typing
NGU	Non-gonococcal urethritis

NR	Nutrient non-requiring phenotype
NT	Nucleotide
Opa	Opacity-associated protein
ParC	Topoisomerase IV
PBP	Penicillin binding protein
PCU	Proline-citrulline-uracil-requiring phenotype
PCR	Polymerase chain reaction
PEN	Penicillin
PFGE	Pulsed field gel electrophoresis
PI	Porin protein
PIA	Proin protein A
PIB	Porin protein B
PID	Pelvic inflammatory disease
PHAC	Public Health Agency of Canada
PMN	Polymorphonuclear leukocyte
PorB	Porin protein B
PPNG	Penicillinase-producing <i>Neisseria gonorrhoeae</i>
QRDR	Quinolone resistance-determining region
QRNG	Quinolone resistant <i>Neisseria gonorrhoeae</i>
RE	Restriction endonuclease
RFLP	Restriction fragment length polymorphism
S	Serotyping
SH	Shanghai
SPT	Spectinomycin
SSDSH	Shanghai Skin Disease and STD Hospital
ST	Sequence type (NG-MAST)
STI	Sexually transmitted infections
TBP	Transferrin binding protein
TbpB	Transferrin binding protein B
TET	Tetracycline
Tf	Human transferrin

TRNG Plasmid-mediated tetracycline resistant *Neisseria gonorrhoeae*  
UQ Urumchi  
WHO World Health Organization



**CHAPTER ONE**

**INTRODUCTION**

## 1.1 Epidemiology and Clinical Features of Gonorrhea

### 1.1.1 Prevalence of Gonorrhea in China and North America

Gonorrhea, caused by the Gram-negative human pathogen *Neisseria gonorrhoeae*, is one of the most common sexually transmitted infections (STIs) worldwide. In 2001, the World Health Organization (WHO) estimated that more than 62 million new gonorrhea cases occur each year worldwide (WHO 2001a; Gerbase et al 1998a/b); this number of new cases is now estimated to be over 82 million each year (WHO 2011). Although realistic goals for the reduction and elimination of *N. gonorrhoeae* infections have been established by many countries since the 1990s, following a worldwide reduction in prevalence, the incidence of gonorrhea is now rising again (Hughes et al 2000; Nicoll & Hamers 2002).

Gonorrhea is the second most commonly reported notifiable disease in the United States (Jajosky 2006). In 2004, a total of 330,132 new cases of gonorrhea were reported. Miller (2004) estimated the prevalence of gonococcal infection among young adults in the US at 0.25% to 0.43%. There was an increase in gonorrhea rates for two consecutive years (2005 and 2006) (CDC 2008). In 2005, 339,593 gonorrhea cases were reported (a slight increase from 2004), and the cumulative incidence rate was 115.6 per 100,000 population (CDC 2007b). In 2006, 358,366 cases were reported and the cumulative incidence rate was 120.9 per 100,000 population, representing an increase of 5.5% from 2005.

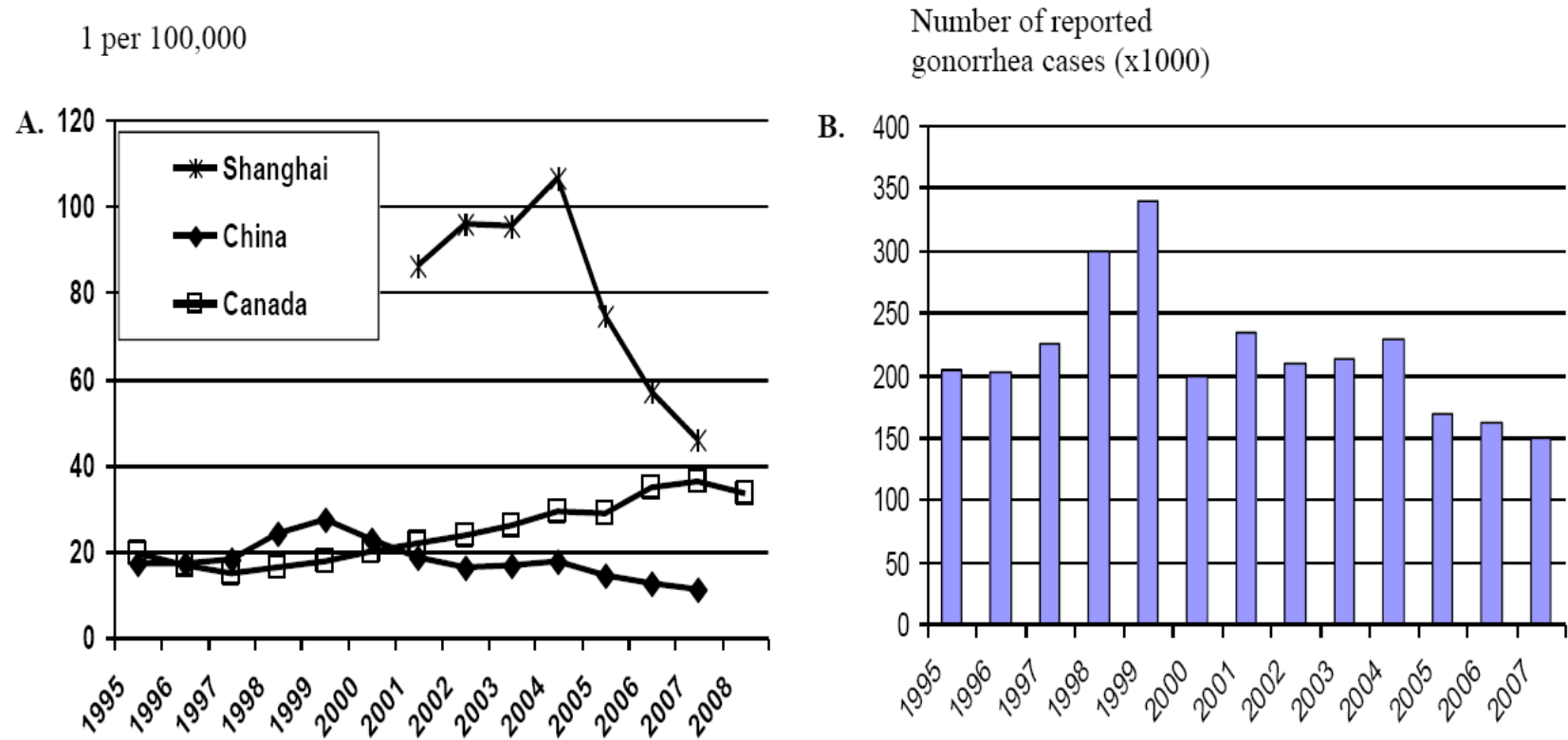
In Canada, gonorrhea has resurged since reaching its lowest rate in 1997 (Hansen et al 2003). In fact, the reported rate almost doubled between 1997 and 2004, from 14.9 to 28.9 per 100,000 population; there was a further increase to 33.2 per 100,000 population in 2008 (PHAC 2008a, 2010). This steady increase in rates since 2000 presents a significant public health concern in Canada.

Reportable STIs in China include syphilis, gonorrhea, *Chlamydia trachomatis* urethritis, non-gonococcal urethritis (NGU), condyloma acuminata, genital herpes simplex virus infections, lymphogranuloma venereum, and chancroid (China CDC 2005, 2006, 2007, 2008).

Overall reported rates of gonorrhea in China increased between 1995 and 1999, reaching 25 per 100,000 population in 1999. In contrast to Canada, rates decreased from 2000, and the rate in 2007 was 14 per 100,000 population (**Fig. 1.1A**). Gonorrhea rates in Shanghai were around 75-107 per 100,000 population from 2001 to 2005—significantly higher than that in other parts of the country. However, a sharp decline has been observed since 2006 (China CDC 2005, 2006, 2007, 2008).

Cohen et al (1996) and others (Chen et al 2000; Shao et al 1996) have comprehensively reviewed STI history in the 20<sup>th</sup> century in China. Syphilis, gonorrhea and other STIs were common before and during the early period of the founding of the People's Republic of China in 1949. The Chinese government launched an STI control program in the early 1950s. Through the 15 year effort, by 1964 STIs including syphilis and gonorrhea were virtually eliminated from the country (Cohen 1996). The situation changed rapidly as China opened its doors to the West in the 1980s and STIs become a public health problem once again. Between 1990 and 1998, syphilis rates increased 20 times and gonorrhea rates increased 2.6 times. During the period from 1989 to 1998, gonorrhea was the most commonly reported STI in China. Since the late 1990s, chlamydial infections have become prevalent; gonorrhea was the second most common STI in 1999. The number of gonorrhea cases reported to the Chinese National Center for STD Control ranged from ~170,000 to 341,000 annually between 1995-2005 (WHO 2010; **Fig. 1.1B**).

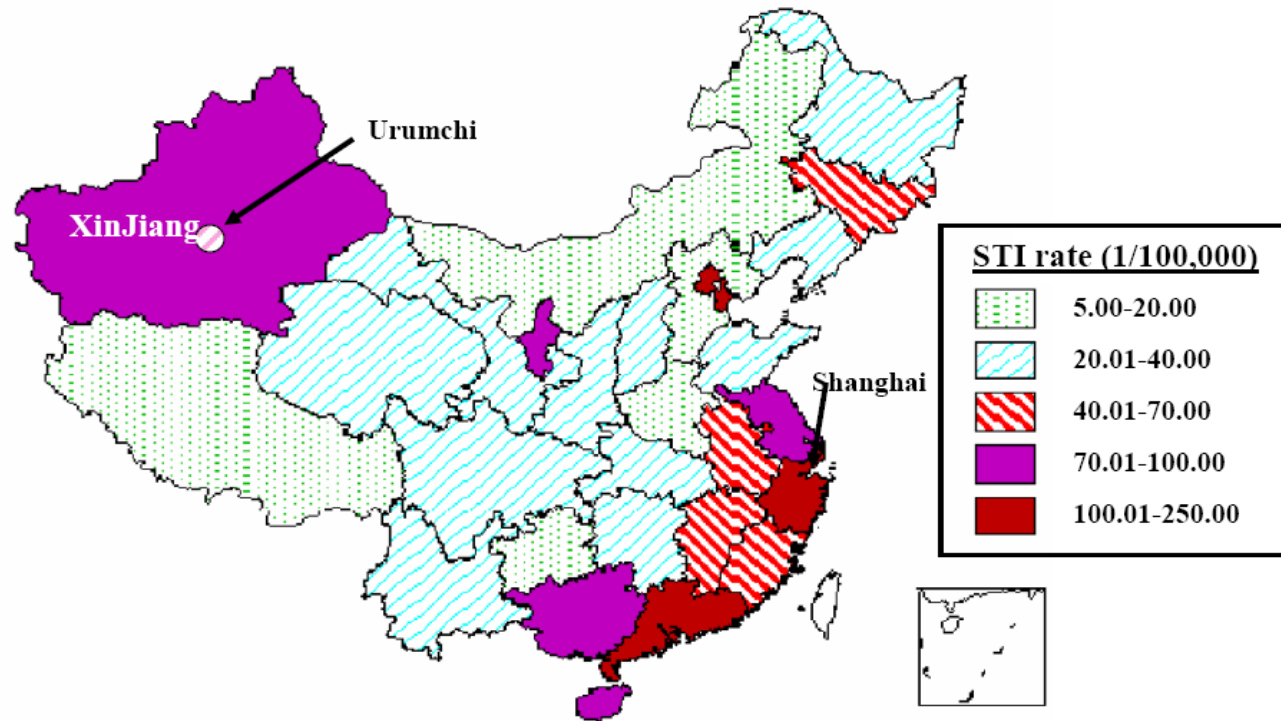
Because of incomplete reporting systems and a lack of appropriate diagnostic tools in rural areas, the number of reported cases of gonorrhea underestimates the true prevalence in China. Care for STIs is delivered at many places other than public STI professional clinics in China, and the use of private sector or non-STI clinics often leads to underreporting (Cohen et al 2000). Indeed, a population-based study showed that the prevalence of gonorrhea was 80 per 100,000 population for women and 20 per 100,000 population for men aged 20 to 64 years, while chlamydial infections were over 50 times higher (Parish et al 2003). The gonorrhea rate in pregnant women was 0.8% (Chen et al 2006a). Detels et al (2003) studied STI prevalence in 1316 market vendors in GuangZhou, a large eastern city in China and found that 1.2% of females and 0.8% of males were infected with gonorrhea. Among men who have sex with men (MSM), the gonorrhea positivity rate was 2.7% (Jiang et al 2006).



**Fig. 1.1 Prevalence of Gonorrhea.** **A.** Gonorrhea rates in China and Canada. **B.** Number of reported gonorrhea cases in China. Chinese data were derived from the China CDC (2005, 2006, 2007 and 2008) and the Communicable Disease Global Atlas of the World Health Organization (WHO 2010). Canadian data were derived from the Public Health Agency of Canada (PHAC 2010).

Among long-distance truck drivers in Tongling city, China, the gonorrhea positivity rate was 8.1% (Chen et al 2006b). Among female sex workers, the rate was over 8% and has been reported as high as 37.8% in various cities in China (van den Hoek et al 2001; Chen et al 2000; Cohen et al 2000; Parish et al 2003; Chen et al 2005). Underreporting remains a concern for the spread of gonorrhea in communities. The economy of China is booming; urbanisation and commercialization are increasing; attitudes toward sex are changing, and the sex industry is growing. However, knowledge about STI prevention is still lacking in populations with high STI risks, as well as in the general population. All of these factors contribute to the high prevalence of STIs, including gonorrhea, in China.

The present research focused on the molecular epidemiology and antimicrobial resistance of *N. gonorrhoeae* in Shanghai and Urumchi, China. Shanghai is the trade capital of China, a city with a population of more than 17 million. Approximately one quarter of the people in Shanghai are migratory, and are more vulnerable to STIs due to disadvantaged social and economic status. Urumchi is the capital of the Xinjiang Province of China. It has a population of over 2 million with 75.3% Han Chinese, 12.8% Uyghurs, 8.0% Hui and 2.3% Kazakhs and Kyrgyz. The STI incidence rates are high, ranging from 70 to 100 per 100,000 population in both Shanghai and Urumchi (**Fig. 1.2**).



**Fig. 1.2 Distribution of Sexually Transmitted Infections (STIs) in China in 2005.** Modified from China CDC (2006). STIs in this report include syphilis, gonorrhea, non-gonococcal urethritis (NGU), condyloma acuminata, genital herpes simplex virus infections, lymphogranuloma venereum (LGV) and chancroid. Locations of the study sites Shanghai and Urumchi are indicated by arrows.

### 1.1.2 Transmission of Gonorrhea

Sexually transmitted infections are transmitted dynamically. STI control programs, like control programs for other infectious diseases, are based on the calculation of the basic reproductive number ( $R_0$ ) (Brunham 2005; May & Anderson 1987; Ward 2007).

$$R_0 = \beta cD$$

$R_0$  represents the number of second-generation cases produced from an infected individual and is determined by 3 parameters: transmission probability ( $\beta$ ), duration of infectiousness ( $D$ ), and the number of individuals that are exposed to the infection (i.e. number of sexual partners) ( $c$ ). If  $R_0$  is greater than 1, the infection will spread in the population; if it is less than 1, the infection will eventually cease to exist in the population. For gonorrhea, based on empirical modeling, it is estimated that the probability of transmission ( $\beta$ ) from a single episode of intercourse was 0.25 for women-to-men transmission and 0.60 for men-to-women transmission, with an average of 0.50 (Jolly & Wylie 2002; Holmes et al 1970; Hooper et al 1978; Nordvik & Liljeros 2006). Gonorrhea is a self-limiting infection. The natural duration of infectiousness ( $D$ ) for gonorrhea is estimated to be 55 days (Yorke et al 1978).

Reducing the duration of infectiousness (through early diagnosis and treatment with antibiotics), the probability of transmission (through promotion of condom use, and vaccination), and the number of sexual partners, effectively reduces  $R_0$ , which leads to control and elimination of the infection ( $R_0 < 1$ ).

Patterns of STI transmission depend upon who has sex with whom, also known as the sexual network. Sexual networks portray the sexual inter-relationships within a defined group of people. As compared to other infections such as the common cold, influenza, or tuberculosis, STIs are the most typical of “network diseases” because the links established through sexual contact are relatively low, and each contact is relatively significant (Day et al 1998). Therefore, sexual network analysis has been used to study the spread of STIs (both outbreak and epidemic) within the context of social interactions.

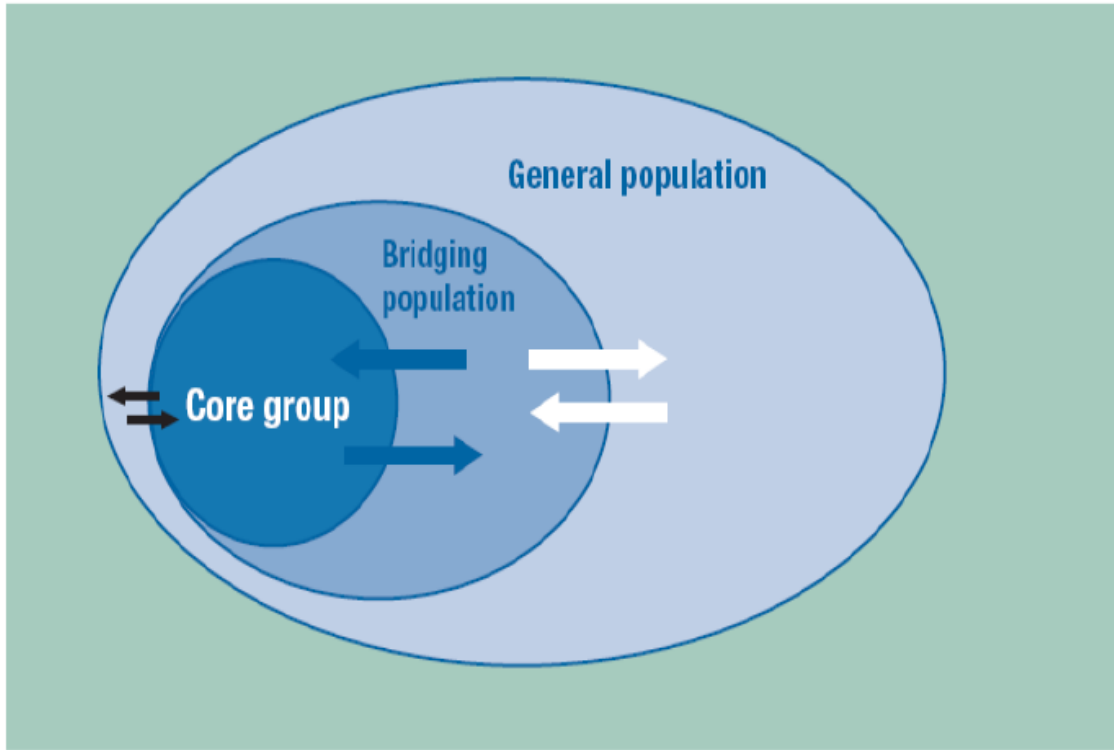
Sexual network analysis has been applied in studies of transmission patterns of chlamydia

and gonorrhoea infections conducted in Manitoba, Canada (Wylie & Jolly 2001; Wylie et al 2005; Jolly & Wylie 2002) and in a gonorrhoea outbreak in Alberta, Canada (De et al 2004).

For gonorrhoea, it has been ascertained that small groups of people joined directly or indirectly through sexual intercourse maintain the continued spread of the infection in populations (Anderson & May 1992; Potterat et al 1985; Yorke et al 1978). These small groups within the population, so called “core groups,” have large numbers of partners, thus are most important in the transmission of infection (Yorke et al 1978; Jolly & Wylie 2002). The infection also spreads into lower-risk populations (bridging populations) who may represent an important sexual link between the core groups and the general population (WHO 2007; **Fig. 1.3**). Therefore, effective identification of core groups in certain populations is critical for the proper and effective distribution of resources (WHO 2007). The role of “core groups” in the transmission of infectious diseases varies depending on the progression of the spreading phases; they are important in the spread of infections during the early epidemic phases, whereas for established endemic infections, transmission among the general population could have a major impact on disease spread (Ward & Rönn 2010). It has been established that intervention strategies should focus on high-risk (core groups) and bridging populations (WHO 2007).

Traditional methods for the identification of sexual networks in STI studies consist of STI surveillance and screening, identification of index cases, partner notification, and contact tracing through extended interviews. A combination of epidemiological and molecular biological methods can establish a much better view of sexual networks in gonorrhoea transmission (Day et al 1998). In a population-based study in London, UK, Choudhury and colleagues (2006) characterized 2045 isolates of *N. gonorrhoeae* by DNA sequence analysis of specific genes (i.e. *porB* and *tbpB*) and matched the sequence types to epidemiological data obtained at the clinics. Twenty-one prevalent strains were identified by molecular determination, each infecting between 20 and 124 individuals. Subsequent analysis on this gonorrhoea population (Risley et al 2007) revealed that strain types were distinct in male-to-male homosexuals and in heterosexuals. Distinct strains, transmitted within localized areas of London, were identified. By combining the molecular information of strain types with demographic data, local transmission networks were identified (Choudhury et al 2006; Risley et al 2007).





**Fig. 1.3 Transmission Dynamics of Sexually Transmitted Infections at the Population Levels.** Adapted from “*Global strategy for the prevention and control of sexually transmitted infections 2006–2015- breaking the chain of transmission. World Health Organization 2007.*” WHO 2007. Permission to use has been obtained (Appendix **A2.1**).

### 1.1.3 Clinical Manifestations and Complications of Gonorrhea

The primary infection sites of *N. gonorrhoeae* are the columnar and transitional epithelium of the urogenital tract (the urethra in males and the uterine cervix in females), the rectal mucosa, the conjunctiva, and pharynx (Sparling 1999; Hook & Handsfield 1999). The incubation period of gonococcal infections is about two to five days after exposure to the organism through sexual contact. Early symptoms may be mild in both men and women. Over 50% of women and 10% of men who have gonorrhea are asymptomatic during the entire infection process. This gives rise to misdiagnosis and delay of treatment, facilitating spread of the pathogen.

In men, primary urethral infection results in acute urethritis, manifested by purulent discharge from the tip of the penis and symptoms of urethral itch and pain or burning sensation when passing urine. In women, primary infections cause cervicitis and urethritis if the urethral tract is involved. Symptoms of primary gonorrhea in females are usually non-specific. There may be a strong smelling vaginal discharge that may be thin and watery or thick and yellow/green. Pain or a burning sensation when passing urine may also be present. Other clinical presentations include abnormal vaginal bleeding and low abdominal pain or tenderness. Rectal infections may cause irritation or discharge of the anus in both men and women, but are often asymptomatic (Sparling 1999; Hook & Handsfield 1999).

Gonococcal ophthalmia neonatorum, an infection in the eyes of the newborn, is acquired during passage through the birth canal of an infected mother (Morse & Beck-Sague 1999). Typically, gonococcal ophthalmia is bilateral and exhibits purulent discharge. The initial conjunctivitis rapidly progresses and, if untreated, results in blindness due to corneal ulceration and perforation. Gonococcal ophthalmia in newborns can be prevented by the instillation of 1% silver nitrate into the conjunctival sac of the newborn (Goldbloom 1994). Current prophylaxis options also include 1% tetracycline drops or 0.5% erythromycin drops applied to newborns eyes within the first hours of life (American Society of Pediatrics 2006). Antibiotic regimens are less likely to cause chemical conjunctivitis than silver nitrate and may be more acceptable to parents (MacDonald et al 2008).

Gonorrhea infection can spread to adjacent sites of the urogenital tract or through the bloodstream to other parts of the body, causing damage and serious complications (Bolan et al 1999). In men, ascending infection of *N. gonorrhoeae* causes epididymitis, a painful condition of the testicles that can lead to infertility if left untreated. Additionally, gonorrhea affects the prostate gland and may cause scarring in the urine canal. In women, the most common consequence of untreated gonorrhea is pelvic inflammatory disease (PID) (Morse & Beck-Sague 1999). Gonococcal PID often appears immediately after the menstrual period. PID causes scar tissue to form in the fallopian tubes, resulting in infertility. If the tube is partially scarred, a fertilized egg may not be able to pass into the uterus. If this happens, the embryo may implant in the tube causing a tubal (ectopic) pregnancy. This serious complication may result in a miscarriage and, possibly, death of the mother.

Rarely, untreated gonorrhea can spread through the bloodstream causing disseminated gonorrhea (DG). DG may present as arthralgia or arthritis, endocarditis, or meningitis in both men and women (Sparling 1999).

Infection with *N. gonorrhoeae* has been associated with increased infectiousness of and susceptibility to the sexually transmitted human immunodeficiency virus (HIV) (Shannon & Cohen 2004). Comprehensive reviews have summarized the findings of clinical trials and epidemiological studies on the interrelationships between HIV and STIs including gonorrhea (Wasserheit 1992; Fleming & Wasserheit 1999; Shannon & Cohen 2004; Galvin & Cohen 2004). It has been shown that both genital ulcerative diseases (syphilis and human simplex virus infections) and nonulcerative STIs (gonorrhea, urogenital chlamydial infections and urogenital trichomoniasis) increase the risk of HIV transmission approximately 3- to 5- fold (Wasserheit 1992). Gonorrhea enhances the infectiousness of HIV due to several pathophysiological factors. These factors include increased HIV viral load in the urethra, semen, and cervical fluid due to high degree of inflammation, as well as increased HIV replication due to the influx of PMNs during gonococcal infections (Shannon & Cohen 2004). Gonorrhea makes a person more susceptible to HIV infection due to damage of the columnar epithelial barriers and increased infiltration of the HIV co-receptor containing cells (Wasserheit 1992; Shannon & Cohen 2004).

These interplays are of great concern because the majority of HIV infections are sexually transmitted (Cohen 2004).

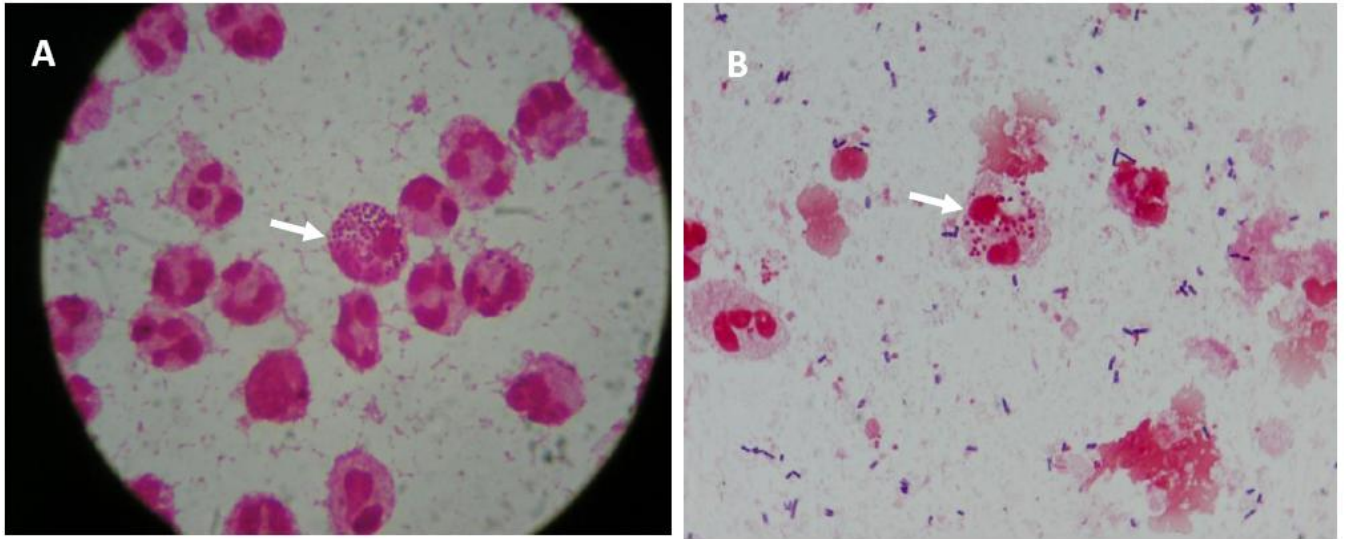
#### **1.1.4 Relevant Pathophysiology of *Neisseria gonorrhoeae***

##### **1.1.4.1 Relevant Biological Characteristics of *N. gonorrhoeae***

*Neisseria gonorrhoeae*, discovered by Albert Ludwig Sigismund Neisser (1855 – 1916), is a member of the *Neisseria* genus, which includes at least 21 members (Knapp 1988) (i.e. *N. gonorrhoeae*, *N. meningitidis*, *N. animalis*, *N. bacilliformis*, *N. canis*, *N. cinerea*, *N. denitrificans*, *N. dentiae*, *N. elongate*, *N. flava*, *N. flavescens*, *N. iguanae*, *N. lactamica*, *N. macacae*, *N. mucosa*, *N. perflava*, *N. pharyngis*, *N. polysaccharea*, *N. sicca*, *N. subflava*, *N. weaver*). *N. gonorrhoeae* and *N. meningitidis* are obligatory human pathogens. Other members of the genus are non-pathogenic commensal species, although some of them can cause opportunistic infections in human (i.e. *N. lactamica*).

*N. gonorrhoeae*, a Gram-negative diplococcus, produces oxidase and utilizes glucose. It does not utilize maltose and sucrose. It is a fastidious microorganism and has special nutrient requirements for growth *in vitro* (sulfur in the form of cysteine and iron). Laboratory cultures are usually undertaken in nutrient-containing media at 35°C under humid conditions and in an environment containing 5-7% CO<sub>2</sub> (Kellogg et al 1963). Under microscopy, in cultured samples, the bacterium appears in pairs. In clinical specimens, gonococci reside inside the polymorphonuclear leukocytes (PMNs) and exhibit coffee-bean shapes (**Fig. 1.4**).

*N. gonorrhoeae* is highly variable in its genotype and phenotype (Fredlund et al 2004; O'Rourke et al 1995). This variability has been used to differentiate gonococcal strains circulating in a given community, thereby identifying patterns of specific strain transmission and guiding control strategies (Unemo et al 2002, 2004, 2007a/b; Viscidi et al 2000; Martin et al 2004). In this study, the characteristics of high variability in gonococcal *porB* and *tbpB* genes were applied to molecular epidemiology. This dual gene analysis has been called *Neisseria gonorrhoeae* Multi-Antigen Sequence Typing (NG-MAST; Martin et al 2004).

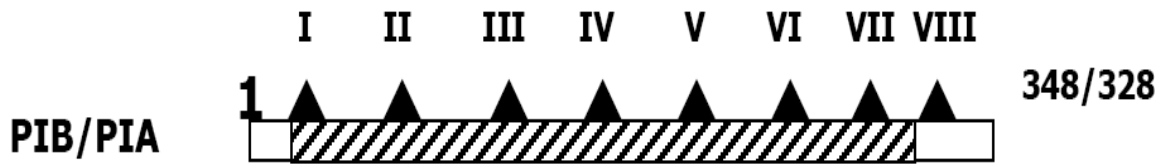


**Fig. 1.4 Gram-stain and Microscopy.** Purulent exudates from a male gonorrhea patient (A) and smears of cervical swabs from a female gonorrhea patient (B). Arrows indicate polymorphonuclear leukocytes containing gonococci. Courtesy from Dr. Wei-Ming Gu, Shanghai Skin Disease and STD Hospital, Shanghai, China

In response to selective pressure, the *porB* genes in *N. gonorrhoeae* undergo positive selection for diversity (Smith et al 1995). Alleles of the *porB* locus are assigned to two isoforms - *porB1a* and *porB1b*—encoding the major porin protein (PI) of *N. gonorrhoeae*, PIA or PIB, respectively (Smith et al 1995). An individual strain of *N. gonorrhoeae* expresses either one of these two PI isoforms, although hybrid PI forms have occasionally been identified from clinical isolates by serological testing (Shinners & Catlin 1988).

Genetically, as compared to *porB1b*, *porB1a* lacks sequence fragments in Loop V-coding regions (van der Ley et al 1991; Derric et al 1999). The PI protein (PorB) is a transmembrane protein comprising eight highly variable loops, separated by nine internal conserved regions (**Fig. 1.5**; van der Ley et al 1991; Derric et al 1999). The loops, which are surface-exposed, can elicit an immune reaction during infection (van der Ley et al 1991; Ison et al 1988) and were targeted for differentiating isolates when serovar determination with monoclonal antibodies was widely available (van der Ley 1991; Ison 1988; Dillon et al 1987a/b, 1990; Kanpp et al 1984; Sanstrom & Danielsson 1980; Sandstrom et al 1982; Tam et al 1982).

The gonococcal *tbp* genes encode human transferrin (Tf) binding proteins (TBPs). The two components of the TBPs (i.e. TbpA and TbpB) both bind to Tf, allowing *N. gonorrhoeae* to scavenge iron from human Tf. TbpA (encoded by *tbpA*), an outer membrane transporter, is a necessary component of the Tf iron acquisition system and is responsible for transporting iron into the bacterial cell. TbpB (encoded by *tbpB*) is a surface-exposed lipoprotein. TbpB proteins are heterogeneous, exhibiting 69 to 84% sequence identity among *N. gonorrhoeae* strains (Retzer et al 1999; Rokbi et al 1995).



**Fig. 1.5 Schematic Presentation of *N. gonorrhoeae* PorB.** The length of PorB differs between PIB (~348 amino acids) and PIA (~328 amino acids), respectively. There are 8 surface exposing loops (I – VIII) as shown in black triangles spanned by inter-space regions (van der Lay et al 1991). DNA sequences used in phylogenetic analysis include coding regions of Loop I to VII as shown in hatched box. DNA sequences in *N. gonorrhoeae* Multi-Antigen Sequence Typing (NG-MAST) analysis included coding sequences for Loop III to Loop VII. The amino acids G120 and A121 locate at Loop III.

#### 1.1.4.2 Major Virulence Factors in *N. gonorrhoeae*

There are four major virulence factors in *N. gonorrhoeae*: pili (Källström et al 1998), opacity-associated proteins (Opa; Dehio et al 1998), porin (Muller et al 1999), and lipooligosaccharide (LOS; Gorter et al 2003). Primary attachment of *N. gonorrhoeae* to the apical surface of mucosal epithelial cells is mediated by the bacterial pilus. This filamentous appendage then retracts, pulling the bacterium down onto the host cell membrane (Howie et al 2005). Opa proteins mediate tight secondary interactions between bacterial cells and the epithelial cells, facilitating invasion. Porins mediate serum resistance in *N. gonorrhoeae*, and facilitate intracellular growth and transcytosis. LOS causes host cell apoptosis and inhibits Opa-mediated bacteria-host cell interactions by sialylation and binding to the asialoglycoprotein receptor of the host cells.

Tissue damage by *N. gonorrhoeae* is caused by the host inflammatory response in which numerous polymorphonuclear leukocytes (PMNs) are attracted to the site of infection and release various chemokines and cytokines (Peeling et al 2006; Simons et al 2005). The inflammatory response causes sloughing of epithelial cells from the urogenital mucosa. The majority of the bacterial cells are washed away by the passage of urine or mucus drainage. Most attached gonococci are discharged along with the sloughed epithelium from the urogenital tract. A small portion of the gonococci inside epithelial cells can be transported across the epithelial cytoplasm to the basal side of the cell, and is subsequently released into subepithelial spaces (McGee et al 1983). Gonococci tend to remain within the niches of the subepithelial compartment, in contact with cells of the immune system but somehow avoiding triggering a specific immune response (Merz & So 2000; Sparling et al 1999). Disseminated gonococcal infections, in rare cases, can then occur if the bacterium penetrates across the endothelium and spread through the bloodstream.



## 1.2 Antimicrobial Resistance in *Neisseria gonorrhoeae* and Treatment of Gonorrhea

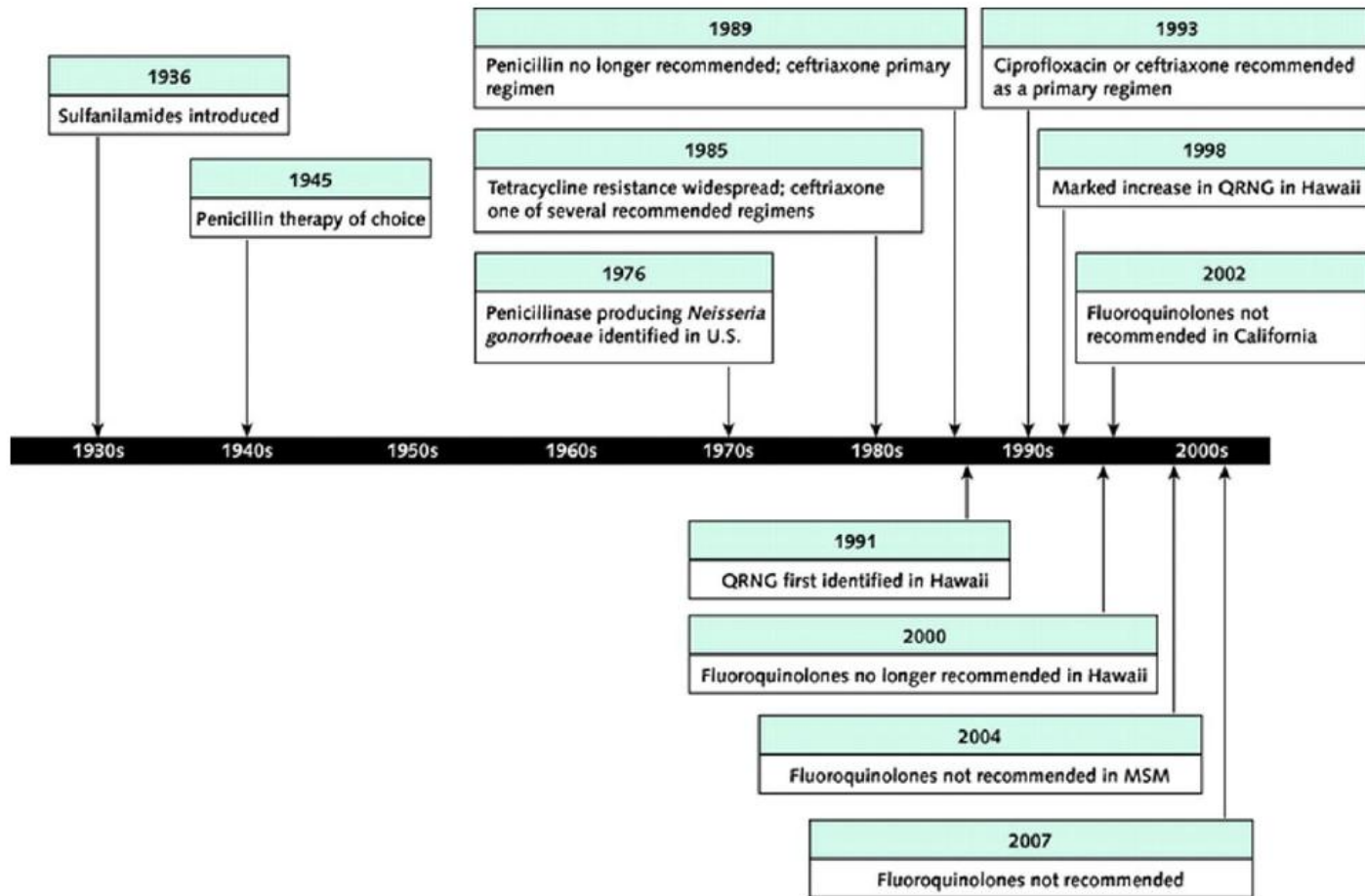
There are no vaccines available against gonococcal infections. Effective prevention and treatment are achieved through a combination of responses (WHO 2007). Control strategies include healthy sexual behaviours such as reduction of the number of sexual partners and the correct use of condoms, early diagnosis, and effective antibiotic treatment.

Antibiotic treatment is the hallmark in curing gonococcal infections and controlling the spread of gonorrhea. According to the accepted definition of gonococcal treatment efficacy, a cure rate of over 95% is required for an antibiotic to be recommended for gonorrhea treatment (Handsfield et al 1992; WHO 2001b; WHO 1989; CDC 1987). Thus, an antibiotic should not be used in situations where resistance is observed in greater than 3% to 5% of gonococcal isolates tested (PHAC 2006).

*N. gonorrhoeae* has developed resistance to most of the commonly used antibiotics. Antimicrobial resistance (AMR) in *N. gonorrhoeae* is increasing in prevalence, and resistance to new classes of antibiotics is emerging and spreading globally (Tapsall et al 2009; Barry & Klausner 2009), giving rise to concerns that gonorrhea may become untreatable.

AMR in *N. gonorrhoeae* is mediated through chromosomal mutations of various loci, plasmid-mediated mechanisms or both (Dillon & Pagotto 1999). Plasmid-mediated resistance may confer resistance to penicillin (i.e. penicillinase-producing *N. gonorrhoeae*, PPNG), or high level resistance to tetracycline (i.e. tetracycline-resistant *N. gonorrhoeae*, TRNG). Chromosomally-mediated resistance (CMR) of *N. gonorrhoeae* is caused by mutations or modifications in various genes. The accumulation of chromosomal mutations may confer resistance to multiple antibiotics (the multiple drug resistance, MDR), or confer higher levels of resistance to single antibiotics (Dillon & Pagotto 1999).

AMR became apparent shortly after the introduction of antimicrobials into clinical practice and has continued to appear and expand to each new class of antibiotics. Recommendations for the treatment of gonorrhea have evolved in accordance to the emergence of new resistance phenotypes and antibiotic availability (Lewis 2010; Workoski et al 2008; **Fig. 1.6**).



**Fig. 1.6 Historical Perspective on Antimicrobial Resistance in *N. gonorrhoeae* in the United States.** Reproduced with permission from Ann Intern Med (Workoski et al 2008; Appendix A2.2).

QRNG = quinolone-resistant *Neisseria gonorrhoeae*; MSM = men who have sex with men

### 1.2.1 Recommendations for the Treatment of Gonorrhea

Sulfanilamides, introduced in 1936, were the first effective anti-gonococcal antibiotics. The use of sulfanilamides was terminated in 1945 because of the spread of resistant *N. gonorrhoeae* isolates (Lees 1946; Kampmeier 1983).

Penicillin became the antibiotic of choice for the next 40 years. The recommended dose of penicillin was continually increased because of a progressive decline in susceptibility. The emergence of high-level, plasmid-mediated resistance to penicillin in 1976 marked the end of penicillin use in the treatment of gonorrhea (Percival et al 1976; CDC 1976). Eventually, treatment with penicillin was discontinued in 1985 in most regions (Dillon & Pagotto 1999).

Tetracyclines were used initially to treat gonorrhea in patients allergic to penicillin, and they are still in use today for treating suspected or proven chlamydial co-infection (CDC2010). However, gonococci became less susceptible to tetracycline shortly after it was introduced (Reyn et al 1958) and was no longer recommended for the treatment of gonorrhea together with together with penicillin in 1985 as plasmid-mediated tetracycline resistant isolates were identified (Roberts et al 1988; CDC 1985; Dillon & Pagotto 1999).

Historically, thiamphenicol has been suggested as a viable alternate therapy regimen to penicillin in the treatment of infections with *N. gonorrhoeae*; however, because cross-resistance to thiamphenicol was common in penicillin-resistant isolates and because thiamphenicol can produce erythroid suppression, thiamphenicol has not commonly used in the treatment of *N. gonorrhoeae* (Dillon et al 1978a/b).

Erythromycin has not recommended for the treatment of gonorrhea because its limited activity against *N. gonorrhoeae* (Brown et al 1977). Azithromycin are used in some Latin American countries although it is not recommended by the WHO as a first-line treatment option for gonorrhea (WHO 2003) because of emergence of resistance and side effects. Gonococcal resistance to azithromycin was observed in Latin America in 1990s (Dillon et al 2006; Sosa et al

2003; Dillon et al 2001). Recently high-level azithromycin-resistant isolates (MIC > 2048 mg/L) were reported in Argentina (Galarza et al 2009) and the UK (Chisholm et al 2009).

In 1993, oral fluoroquinolones (ciprofloxacin and ofloxacin) were recommended for gonorrhoea treatment (CDC 1993). However, the emergence of quinolone-resistance *N. gonorrhoeae* (QRNG) became a concern in 1991 in the US and in the Asia-Western Pacific regions (Iverson et al 2004; Tapsall 2002, 2005, 2006; Tapsall et al 1998). Since then, the rates of QRNG continuously increased and spread in the US and worldwide. In 2006, the US CDC announced that quinolones were no longer recommended for the treatment of gonorrhoea (CDC 2007a). Trends in treatment recommendations for gonorrhoea in Canada have been similar to those in the US (PHAC 2006, 2007). Due to the rapid increase in rates of QRNG, quinolones such as ciprofloxacin and ofloxacin have not been recommended for the treatment of gonococcal infections in Canada since 2007 (PHAC 2008a/b).

Because of global spread of QRNG, third-generation cephalosporins are currently the only class of antimicrobials available for effective treatment of gonorrhoea (Tapsall 2002, 2005, 2006). Many countries recommend injectable ceftriaxone or orally administered cefixime as the antibiotics of choice (**Table 1.1**), including Canada (PHAC 2007, 2008a/b), Australia (Sexual Health Society of Victoria 2008), the United States (CDC 2006, 2007a, 2010), the United Kingdom (HPA 2005), China (Wang & Zhang 2007) and Japan (Jpn Soc STD 2006).

Spectinomycin has been recommended as an alternative treatment regimen for gonorrhoea (**Table 1.1**). However, shortly after its introduction and wide use in the mid-1980s, clinical treatment failures caused by spectinomycin-resistant strains began to be appear in US military personnel in the Republic of Korea (Boslego et al 1987). Gonococcal resistance to spectinomycin has also been reported from the Western Pacific regions (WHO-WPR 2001) and from the Latin American countries (Dillon et al 2006). Aminoglycosides kanamycin and gentamicin are rarely used for the treatment of gonorrhoea because of their low activity against *N. gonorrhoeae* and their toxicity (Dillon 1992; WHO 2003).

**Table 1.1 Current Recommendations of First Line Antibiotics for the Treatment of Uncomplicated Gonorrhoea<sup>†</sup>**

Countries/ Regions	Recommended Antibiotics	Alternative Treatment Regimens	References
Australia	Ceftriaxone	NA	Sexual Health Society of Victoria 2008
Canada	Cefixime	Ceftriaxone, or Azithromycin, or Spectinomycin,	PHAC 2008b
China	Ceftriaxone	Spectinomycin	Wang & Zhang 2007; Su et al 2007; China Ministry of Health 2000
Japan	Ceftriaxone, or Spectinomycin	Cefixime	Jap Soc STD 2006; Yokoi et al 2007
United Kingdom	Ceftriaxone, or Cefixime, or Spectinomycin	Cefotaxime, or Cefpodoxime, or Azithromycin	HPA 2005, 2011
United States	Ceftriaxone or Cefixime	Cefpodoxime or Cefuroxime, or Azithromycin	CDC 2010

<sup>†</sup>: As of February 2011. For more discussion, please refer to Discussion Section of this thesis.

NA: Not recommended

### 1.2.2 Prevalence of Antimicrobial Resistance in *N. gonorrhoeae* in China and Canada

Antimicrobial resistance (AMR) in *N. gonorrhoeae* poses a significant public health burden worldwide because of its high prevalence and the emergence and spread of resistance to new classes of antimicrobials (Tapsall 2009a/b). In most areas of the world, *N. gonorrhoeae* has developed resistance to sulfanamides, penicillins, tetracyclines, macrolides and fluoroquinolones. Decreased susceptibility and sporadic resistance to third-generation cephalosporins, and to spectinomycin, has also been observed. Moreover, multiple drug resistant *N. gonorrhoeae* isolates are commonly observed in various areas of the world (Tapsall 2002, 2005, 2006, 2009). The global resistance status and trends in *N. gonorrhoeae* have been extensively reviewed by WHO and a variety of researchers (Tapsall 2002, 2005, 2006, 2009; Dillon & Pagotto 1999; WHO 2001a/b). In this section, trends of AMR in *N. gonorrhoeae* since the mid-1990s in China are summarized and are compared to those in Canada. Data were derived from the WHO-WPR reports (WHO-WPR1997a/b, 1998, 2000a/b, 2001, 2001, 2003, 2005, 2006a/b, 2008, 2010) and reports of the Public Health Agency of Canada (PHAC 2008a, 2010).

The burden of gonococcal penicillin resistance (PEN<sup>R</sup>, MIC<sub>50</sub>≥1.0 mg/L) has been high in the past 15 years in China; over 50% to nearly 100% isolates were resistant to PEN in China as a whole and in Shanghai (Gu et al 2004) (**Fig. 1.7**). The overall resistance percentages to PEN have not been reported by the national surveillance program since 2006. For comparison, PEN<sup>R</sup> (MIC<sub>50</sub>≥2.0 mg/L) percentages in Canada are around 10-18% (PHAC 2008a). However, the PEN<sup>R</sup> percentages in Canada are still above the threshold of 3-5% resistance recommended by WHO (WHO 1989) for termination of use of that particular antibiotic for the treatment of gonorrhea (PHAC 2006).

Tetracyclines (TET) are not commonly used for the treatment of gonorrhea in China; in the early 1990s, however, they were used in combination with PEN for treating genital co-infections due to *Chlamydia trachomatis*. Thus, the overall TET resistance (TET<sup>R</sup>, MIC<sub>50</sub>≥1.0 mg/L) percentages have not been reported. In Shanghai, TET<sup>R</sup> percentages are reported and the percentages increased from ~ 8% in 1995 to ~85% in 1999 and to 99% in 2002. The TET<sup>R</sup> percentages have remained high in the past 4 years (74-82%; Gu et al 2004). In Canada, TET<sup>R</sup>

(MIC $\geq$ 2.0 mg/L) was observed in the early 1970s (Dillon et al 1978b) and was highly prevalent in gonococcal isolates tested in the 2000s (Greco et al 2003). TET<sup>R</sup> percentages remained around 15-29% from 1999-2006 (**Fig. 1.8**; PHAC 2008a).

Fluoroquinolones were introduced in the early 1990s, and orally administered ciprofloxacin (CIP) had been recommended for the treatment of gonorrhoea since 1995 in China. The percentages of CIP resistance (CIP<sup>R</sup>, MIC $\geq$ 1.0 mg/L) drastically increased from 15% in 1996 to > 50% in 1998, > 85% in 2000, and > 95% in 2006 (Ye et al 2004; WHO-WPR 2010). Thus, the use of CIP for the treatment of gonorrhoea was terminated in the mid-2000s in China as well as many other countries (Wang & Zhang 2007; PHAC 2008b; CDC 2007a). In Shanghai, the burden of CIP resistance is even higher than the overall burden in China - almost all isolates tested have been resistant to CIP since 1997. For comparison, the CIP<sup>R</sup> percentages in Canada were low before 2003 (< 5%); however, the CIP<sup>R</sup> percentages increased to 6% in 2004, 14% in 2005 and 28% in 2006 (**Fig. 1.9**, PHAC 2010).

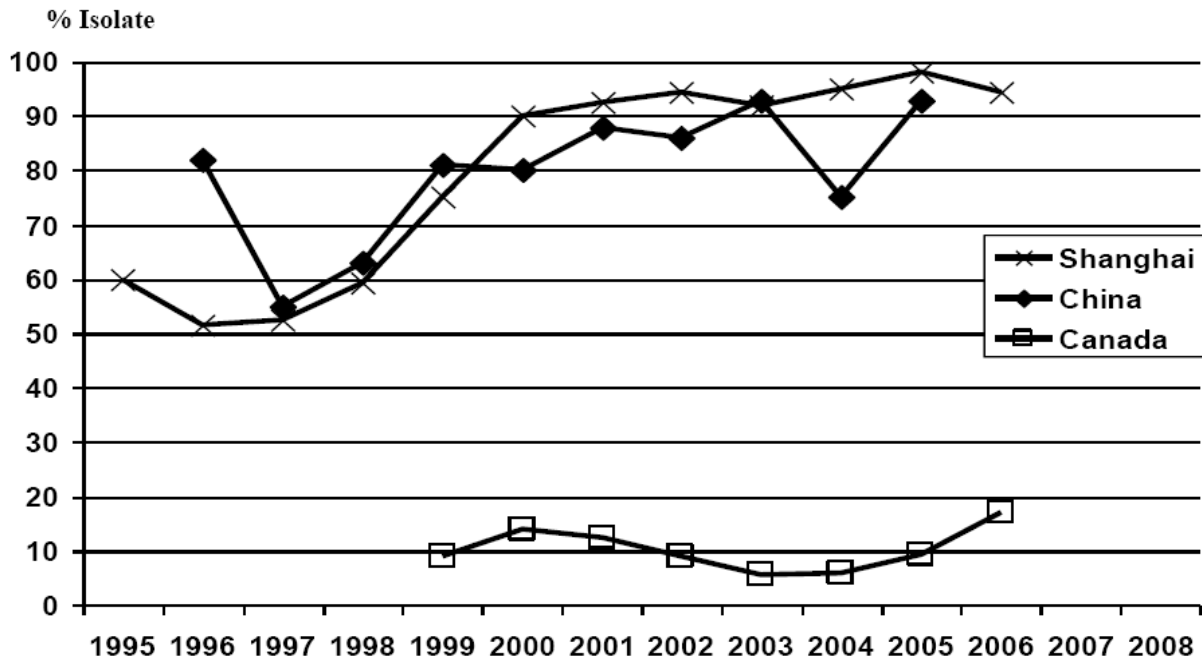
The prevalence of plasmid-mediated resistance in *N. gonorrhoeae* has drastically increased since 1998 in China (**Fig. 1.10**). The percentage of penicillinase-producing *N. gonorrhoeae* (PPNG,  $\beta$ -lactamase positive) was less than 10% before 1999, but rapidly increased to over 50% in 2004. PPNG prevalence in China has remained high over the past 5 years (38-48%). Plasmid-mediated tetracycline resistance *N. gonorrhoeae* (TRNG, TET MIC  $\geq$  16.0 mg/L) was first reported in 1995, and increased to 34% in 2001 and 40% in 2008. In Shanghai, the trends of PPNG are similar to those in China overall, although higher percentages were observed. The TRNG percentages in Shanghai were lower than the overall percentages in China before 2006. Noticeably, the TRNG percentages in Shanghai significantly increased in the past 4 years, from ~21% in 2005 (Yang et al 2006) to 56% in 2008. In Canada, the TRNG percentages rose from 0.02% of reported cases (6 of 35,287) in 1986 and peaked at 18.9% of reported cases (1,164 of 6,167) in 1994 (Greco et al 2003).

Gonococci resistant to spectinomycin (SPT<sup>R</sup>, MIC $\geq$ 128.0 mg/L) or with reduced susceptibility to ceftriaxone (CRO<sup>Red</sup>, MICs=0.06-0.25 mg/L) were sporadically reported in various years in China (less than 0.5% of the isolates surveyed) (Ye et al 1994, 2002, 2003, 2004;

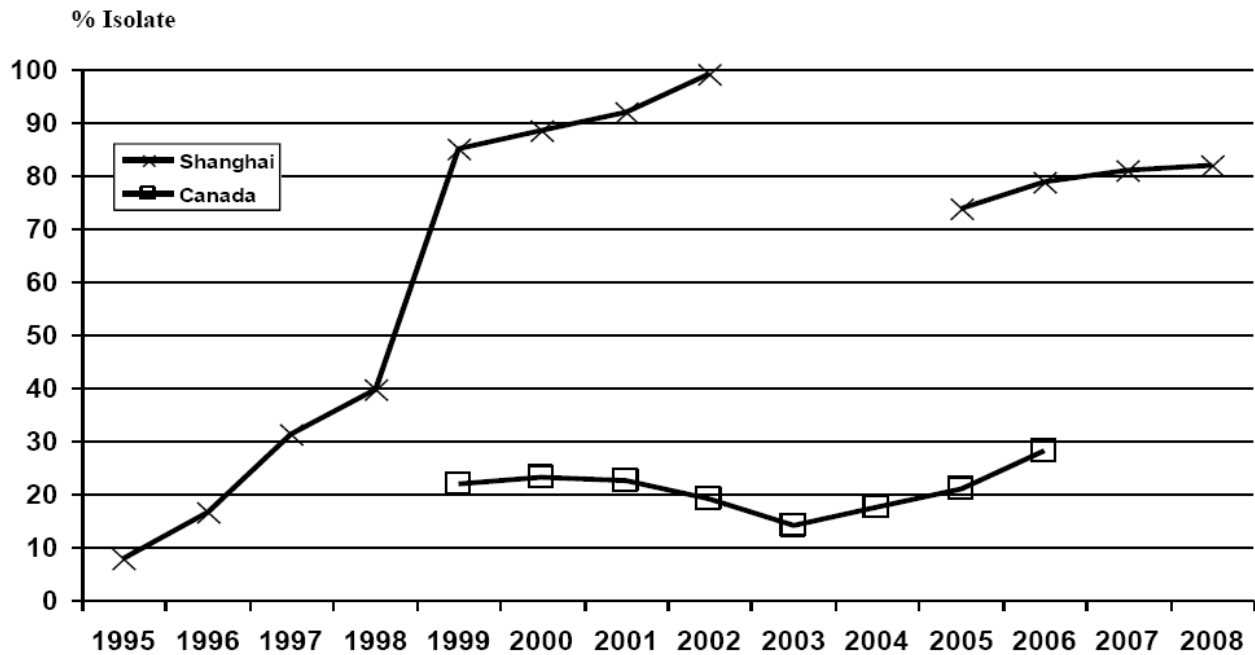
Su et al 2007; WHO-WPR1997a/b, 1998, 2000a/b, 2001, 2002, 2003, 2005, 2006a/b, 2008, 2010); however, the data used in these reports were obtained from local STI centers in China and lacked confirmation from the National Reference Laboratory of China CDC in Nanjing, China.

Detailed data on the trends of multiple drug resistance (MDR) of *N. gonorrhoeae* in China are not available. However, with consideration of the high percentages of PEN<sup>R</sup>, TET<sup>R</sup>, and CIP<sup>R</sup>, it can be expected that the MDR phenotypes of PEN<sup>R</sup>/TET<sup>R</sup>/CIP<sup>R</sup> are high in China and that the phenotypes of PEN, TET, or CIP resistance, combined with SPT<sup>R</sup> or decreased susceptibility to CRO, may also be present.

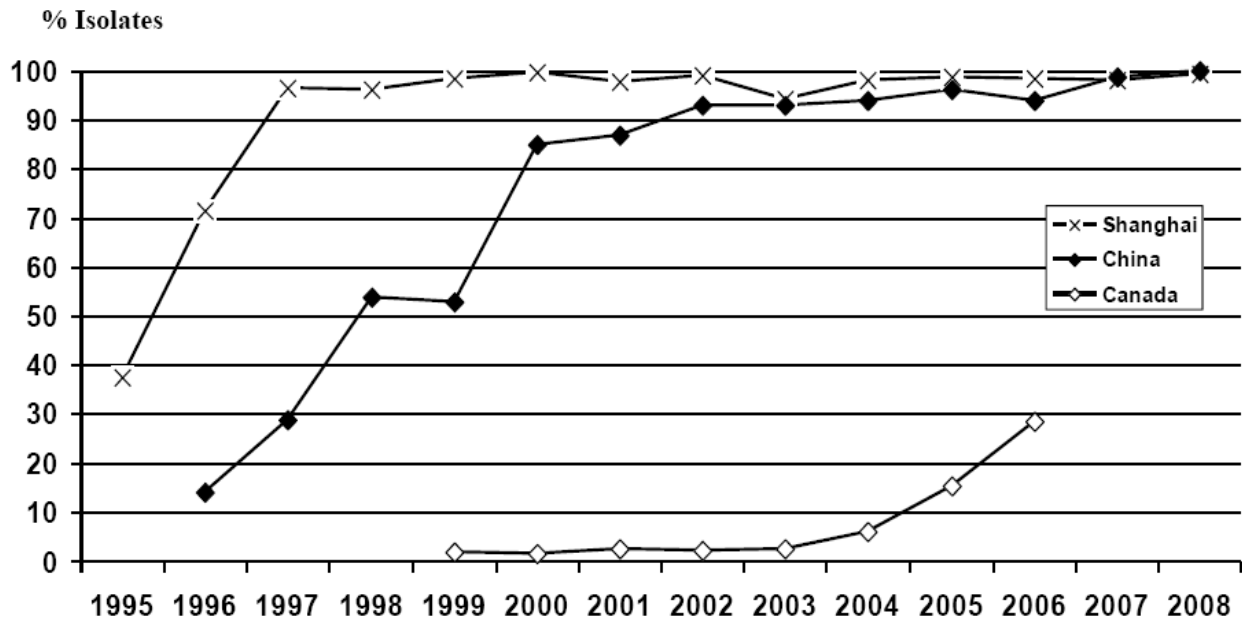




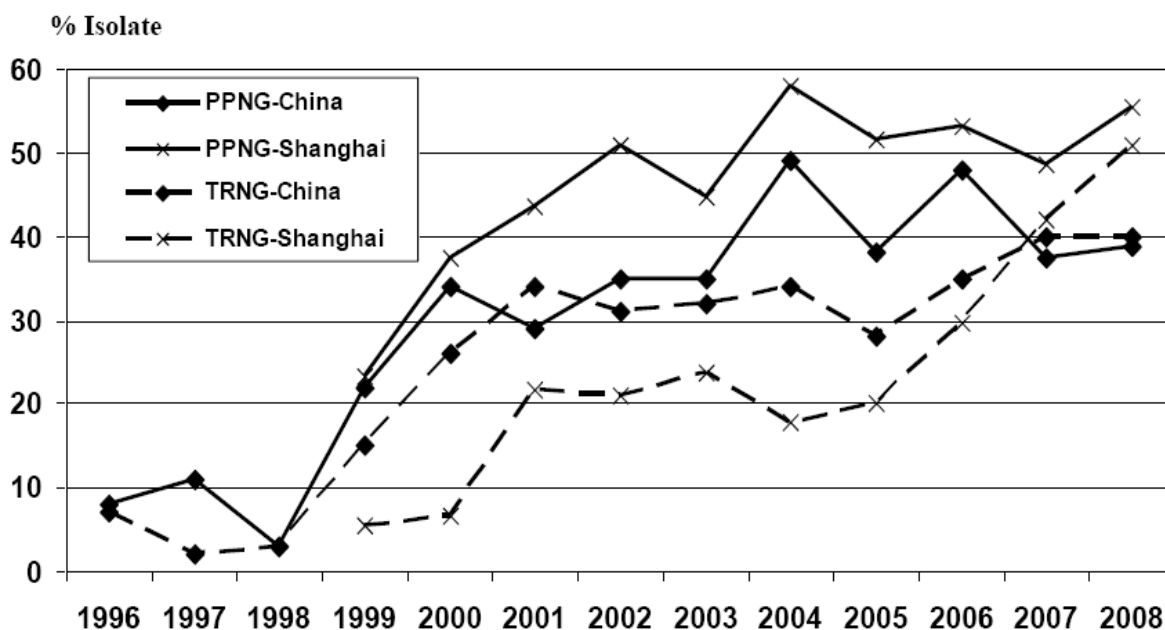
**Fig. 1.7 Trends of Penicillin Resistance in *N. gonorrhoeae*.** Chinese data were derived from WHO-WPR Reports (WHO-WPR1997a/b, 1998, 2000a/b, 2001, 2001, 2003, 2005, 2006a/b, 2008, 2010). Shanghai data were derived from Gu et al 2004. Shanghai data for 2005-2007 were courtesy of Gu (unpublished data, personal communication). Since 2006, China has not reported overall PEN resistance rates. Canadian data were derived from the Public Health Agency of Canada (PHAC 2008c). Penicillin resistance breakpoints were MIC = 1.0 mg/L in China and 2.0 mg/L in Canada, respectively.



**Fig. 1.8 Trends of Tetracycline Resistance in *N. gonorrhoeae*.** The overall rates of TET resistance were not available. Shanghai data were derived from Gu et al 2004. Shanghai data for 2005-2008 were courtesy of Gu (unpublished data, personal communication). Canadian data were derived from the Public Health Agency of Canada (PHAC 2008c). Tetracycline resistance breakpoints were MIC = 1.0 mg/L in China and 2.0 mg/L in Canada, respectively. Tetracycline resistant data in Shanghai for 2003 and 2004 were not available.



**Fig. 1.9 Trends of Ciprofloxacin Resistance in *N. gonorrhoeae*.** Chinese data were derived from WHO WPR Reports (WHO-WPR1997a/b, 1998, 2000a/b, 2001, 2001, 2003, 2005, 2006a/b, 2008, 2010). Shanghai data were derived from Gu et al 2004. Shanghai data for 2005-2008 were courtesy from Gu (unpublished data, personal communication). Canadian data were derived from the Public Health Agency of Canada website (PHAC 2008c). Ciprofloxacin resistance breakpoint was P MIC = 1.0 mg/L in both China and Canada.



**Fig. 1.10 Trends of PPNG and TRNG in China.** Chinese data were derived from WHO WPR Reports (WHO-WPR1997a/b, 1998, 2000a/b, 2001, 2001, 2003, 2005, 2006a/b, 2008, 2010). Shanghai data were derived from Gu et al 2004. Shanghai data for 2005-2008 were courtesy of Gu (unpublished data, personal communication).

PPNG = Penicillinase-producing *N. gonorrhoeae*; TRNG = Tetracycline resistance *N. gonorrhoeae* (plasmid mediated, TET MIC  $\geq$  16.0 mg/L).

### 1.3 Modes of Action and Mechanisms of Antimicrobial Resistance in *Neisseria gonorrhoeae*

Based on the modes of action, commonly used antibiotics are generally categorized into three classes (Walsh 2003; Courvalin & Leclercq 2010). Drugs that act on the cell wall include the  $\beta$ -lactams (e.g. penicillins, cephalosporins, monobactams and carbapenems) and the glycopeptides (e.g. vancomycin, teicoplanin, telavancin, bleomycin and ramoplanin). Drugs that act on protein synthesis comprise the macrolides (e.g. erythromycin and azithromycin), tetracyclines (e.g. tetracycline and doxycycline), spectinomycin, and aminoglycosides (e.g. amikacin, gentamicin, kanamycin, neomycin, streptomycin, tobramycin and oxazolidinones). Antimicrobials that act on DNA replication and repair include fluoroquinolones. Other classes are antibiotics active against membranes (i.e. polymyxins), inhibits folate synthesis (e.g. sulfonamides), or are cationic peptides.

Over their long history of evolution, bacteria have developed various ways to protect themselves from antimicrobial attacks. These mechanisms can be generally categorized into four groups (Jayaraman 2008, 2009): 1) restriction of intracellular drug concentration by influx and efflux, 2) chemical modifications or destruction of drugs, 3) alterations of drug targets in bacteria, and 4) bacterial tolerant states which are associated with persistence, biofilm formation, and swarming. Some mechanisms mediate cross-resistance to multiple unrelated drugs, whereas more than one resistant mechanism can co-exist in a microorganism against a particular antibiotic.

Generally, gonococcal resistance to antimicrobial agents can be classified as plasmid-mediated or chromosomally mediated resistance or both (Dillon & Pagotto 1999; Tapsall 2002).

Plasmid-mediated resistance may confer resistance to penicillin (i.e. PPNG), or high-level resistance to tetracycline (i.e. TRNG). PPNG isolates harbor plasmids containing  $\beta$ -lactamase producing determinant (Dillon & Yeung 1986). Penicillinase production in these plasmids is mediated by a TEM1-type  $\beta$ -lactamase encoded by the TnA transposon Tn2, which is truncated and includes 84% of *tnpR*, noncoding sequences, the entire *bla* gene, and the right inverted repeat (IR-R) (Chen & Clowes 1987; Fayet et al 1982). TEM-1 was incorporated onto a plasmid

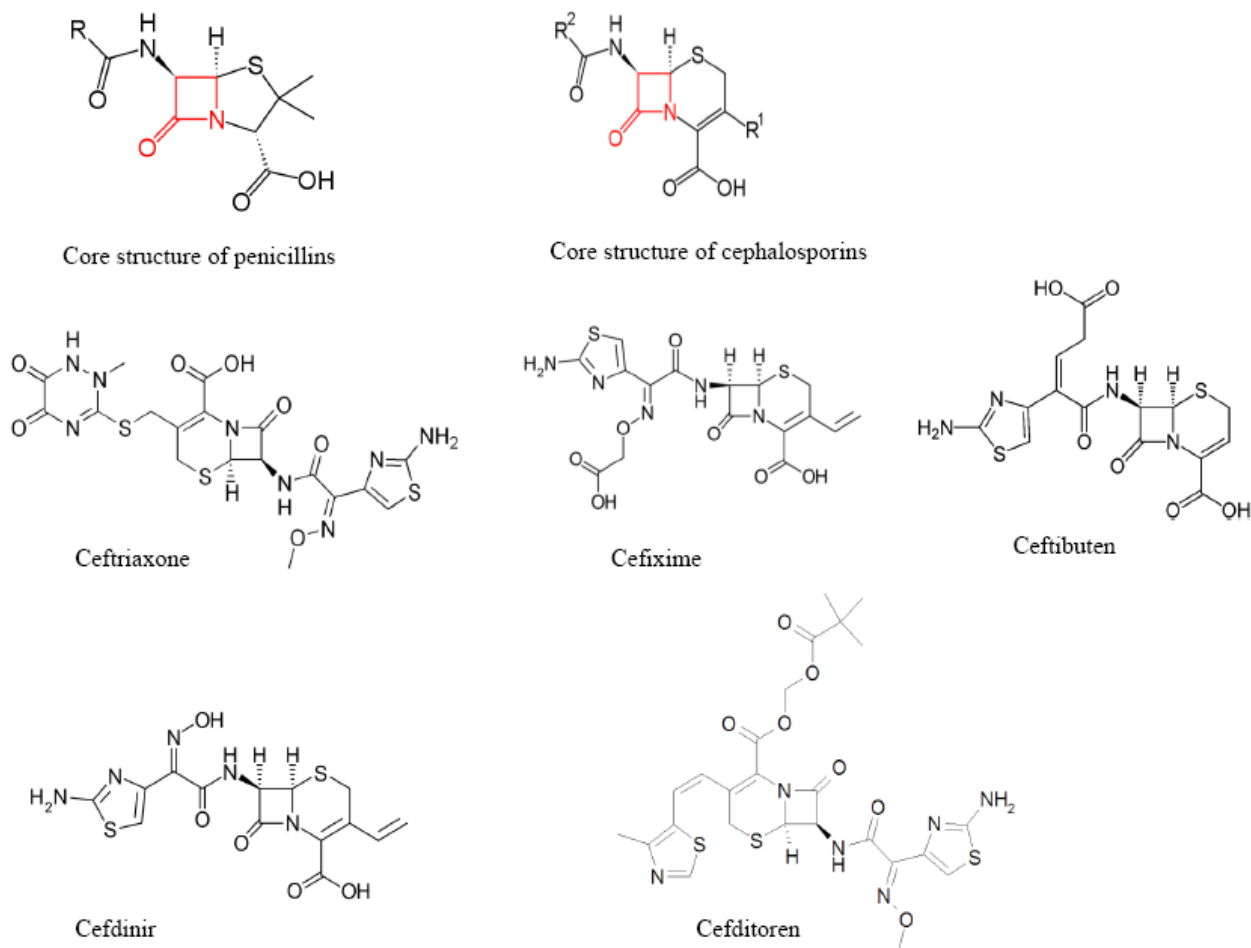
originally found in *Haemophilus* species which was mobilized into *N. gonorrhoeae* (Dillon & Yeung 1989; Brunton et al 1986). TRNG is associated with *tetM* determinant-containing plasmids which were created in nature as the result of the insertion of a *tetM*-like sequence into the endogenous gonococcal conjugative plasmid (Morse et al 1986; Swartley et al 1993; Greco et al 2003). The *tetM* determinant was originally described in *Streptococcus* species as a mobile, transposon-borne element which causes the release of tetracycline from the ribosome. In some cases, the *tetM* determinant is located on the chromosome in both *N. gonorrhoeae* and other species (Morse et al 1986; Swartley et al 1993).

Mutations at various loci, singularly or in combination, are associated with chromosomally mediated resistance (CMR; Tapsall 2009a/b). The potential CMR determinants in *N. gonorrhoeae* include the quinolone resistance determining regions (QRDRs) in *gyrA* and *parC*, *porB*, *penA*, *mtrR* and *ponA* (Dillon & Pagotto 1999; Tapsall 2009a/b). The accumulation of chromosomal mutations may confer resistance to multiple antibiotics (i.e. MDR), or confer higher levels of resistance to single antibiotics (Tapsall 2009a/b; WHO 2001; Dillon & Pagotto 1999).

The following sections summarize the modes of action and mechanisms of gonococcal antimicrobial resistance, focusing on antibiotics that have been used for the treatment of gonorrhoea.

### 1.3.1 $\beta$ -lactams: Penicillin and Cephalosporins

The core chemical structure of  $\beta$ -lactams is the four-membered  $\beta$ -lactam-ring consisting of 3 carbon atoms and one nitrogen atom.  $\beta$ -lactam antibiotics include penicillins, cephalosporins, cephamycins, carbapenems, monobactams, and  $\beta$ -lactamase inhibitors (**Fig. 1.11**). The different structure of side chains and other moieties adjacent to the  $\beta$ -lactam-ring give rise to variety of antimicrobial spectra and susceptibility to  $\beta$ -lactamase degradation. This class of antibiotics inhibits bacterial cell wall synthesis.



**Fig. 1.11 Structure of  $\beta$ -lactam Antibiotics- Penicillin and Third-generation Cephalosporins.**

The core chemical structure of penicillins and cephalosporins is the four-membered  $\beta$ -lactam ring consisting 3 carbon atoms and one nitrogen atom (in red in the core structure). Structures of third-generation cephalosporins which have been used for the treatment of gonorrhoea are shown [i.e. ceftriaxone, cefixime, cefibuten, cefdinir and cefditoren].

Adapted from Wikimedia ([http://en.wikipedia.org/wiki/Cephalosporin#cite\\_note-0](http://en.wikipedia.org/wiki/Cephalosporin#cite_note-0), accessed March 2011).

### 1.3.1.1 Penicillins

The discovery of penicillin is attributed to Scottish scientist and Nobel laureate Alexander Fleming in 1928 (Ho 2000, <http://205.188.238.181/time/time100/scientist/profile/fleming.html>). Chemically, penicillins are derivatives of a 6 amino penicillanic acid nucleus (6 APA) which is essential for biological activity. In penicillins, the  $\beta$ -lactam-ring is fused to a five-membered sulfur ring system (**Fig. 1.11**). Penicillins covalently acylate and subsequently inactivate the cell wall transpeptidases known as penicillin-binding proteins (PBPs) to inhibit peptidoglycan (PG) transpeptidation reactions (Waxman & Strominger 1983; Walsh et al 2003; Zapun et al 2008). Penicillin had been used for the treatment of gonorrhoea from 1945 to the late 1980s (Workoski et al 2008).

Penicillin resistance in *N. gonorrhoeae* can be mediated by  $\beta$ -lactamase (penicillinase)-producing plasmids in PPNG, mutations of various chromosomal genes, or both (Dillon & Pagotto 1999). Mutations at various loci, singularly or in combination, are associated with chromosomally mediated resistance (CMR) to penicillin in *N. gonorrhoeae* (Tapsall 2009a/b; Tanaka et al 2006). The resistance-associated loci include *porB* (coding for PorB) (van der Ley et al 1991; Gill et al 1998), *mtrR* (coding for MtrR) and the *mtrR* promoter (Hagman et al 1995), *penA* (coding for PBP2; Dougherty et al 1980) and *ponA* (coding for PBP1; Ropp & Nicholas 1997).

PorB, a porin, allows the passage of small molecules, such as  $\beta$ -lactams and tetracyclines, through the outer membrane (Danielsson et al 1986; Scudamore et al 1979). Each gonococcal isolate, designated as *porB*1a and *porB*1b encoding PIA or PIB proteins, respectively (Gotschlich et al 1987; Unemo et al 2002), contains only one of the two *porB* alleles, although hybrid porins have been reported (Cooke et al 1998; Gill et al 1994). PorB protein comprises eight surface-exposed loops and the transmembrane regions interspaced the loops (**Fig. 1.5**, page 15). The surface exposed-loop regions of PorB have a high frequency of amino acid variations (Ison et al 1988; Smith et al 1995). The PIA phenotype is associated with higher susceptibility to  $\beta$ -lactams and tetracyclines (Olesky et al 2006; Liao et al 2008). Amino acid substitutions at Gly-120 and Ala-121 of loop 3 of PorB are associated with decreased susceptibility to  $\beta$ -lactams and tetracyclines (Olesky et al 2002), and recently, G120K/A121D mutations in PorB were found to



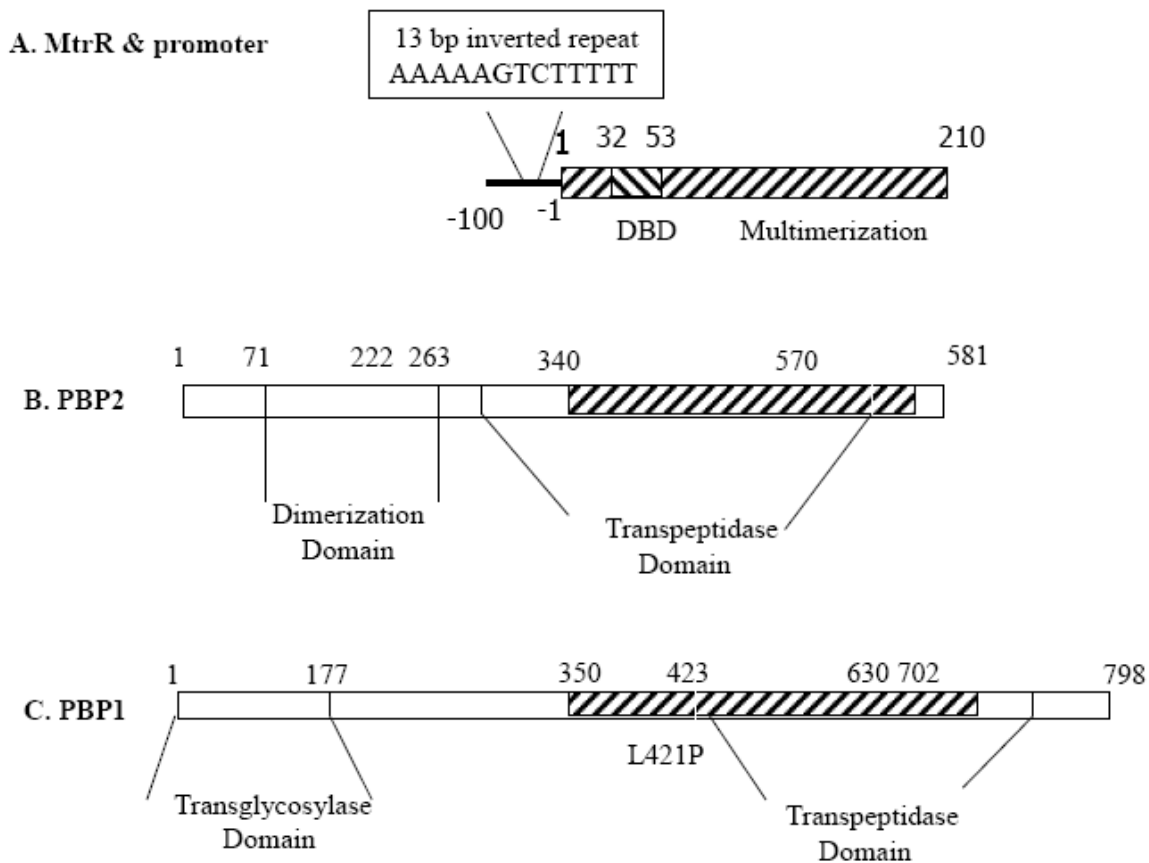
be associated with decreased susceptibility of *N. gonorrhoeae* isolates to penicillins or third-generation cephalosporins (Zhao et al 2009; Tanaka et al 2006; Tapsall 2009a/b).

MtrR (**Fig. 1.12A**) is a protein that represses the expression of the *N. gonorrhoeae* MtrC/D/E efflux system, which exports hydrophobic antimicrobials such as tetracycline (Hagman et al 1995; Hagman & Shafer 1995). Mutations in MtrR can reduce MtrR repression of MtrC/D/E expression and result in enhanced resistance to hydrophobic agents (Hagman et al 1995). Mutations in MtrR in clinical isolates of *N. gonorrhoeae*, which cause resistance to hydrophobic antimicrobial agents, include the alteration of its DNA binding domain (AA32-53) through A39T and G45D (Tanaka et al 2006; Zarantonelli et al 1999) mutations as well as H105Y or E202G mutations in the dimerization domain (AA54-210) of MtrR (Shafer et al 1995). These mutations may appear singularly or in combination. Also, a single nucleotide deletion (-A) within the 13bp inverted repeat of the *mtrR* promoter reduces MtrR expression (Hagman & Shafer 1995), thereby alleviating repression of the efflux pump.

Three major penicillin binding proteins (PBPs) are expressed in *N. gonorrhoeae*, namely PBP1, PBP2 and PBP3 (Dougherty et al 1980; Spratt & Cromie 1988). PBPs possess an amino-terminal peptidoglycan transglycosylase domain and a carboxy-terminal penicillin-sensitive transpeptidase domain (Dougherty et al 1980; Spratt & Cromie 1988). PBPs are the targets of  $\beta$ -lactam antibiotics (Dougherty et al 1980). Antibiotic binding to the active site of transpeptidase domain in PBPs is required for acylation of the PBPs by  $\beta$ -lactam antibiotics.

In *N. gonorrhoeae*, among the three PBPs, PBP2 (**Fig. 1.12B**) has the highest affinity for penicillin binding (Spratt 1988; Ameyama et al 2002). Research suggests that insertion of Asp-346 or other mutations in the transpeptidase domain at the C-terminus of PBP2 (AA263-570) are associated with altered protein affinity to penicillin (PEN) and PEN resistance of *N. gonorrhoeae* (Spratt 1988; Ameyama et al 2002).

PBP1 proteins (**Fig. 1.12C**; Ropp & Nicholas 1997) with a L421P mutation exhibit decreased rates of acylation by  $\beta$ -lactam antibiotics and reduced affinity to penicillin, resulting in high-level penicillin resistance (Ropp et al 2002).



**Fig. 1.12 Schematic Presentation of Antimicrobial Resistance Determinants in *N. gonorrhoeae*.** Amino acid positions were indicated on the top of each sequence. Hatched segments were the regions analyzed. **A. MtrR.** Promoter region (-1 to -100) was shown with the 13 bp inverted repeat. Locations of the DNA binding domain (DBD) and the dimerization domain were indicated (Hagman & Shafer 1995; Lucas et al 1997). **B. PBP2 (Penicillin Binding Protein 2).** The N-terminal dimerization domain and the C-terminal transpeptidase domain were shown (Dougherty et al 1980). **C. PBP1 (Penicillin Binding Protein 1).** The N-terminal transglycosylase and the C-terminal transpeptidase domain were shown (Ropp & Nicholas 1997).

### 1.3.1.2 Cephalosporins

Cephalosporins are the most commonly prescribed class of  $\beta$ -lactam antibiotics for treating both Gram-positive and Gram-negative bacterial infections. Cephalosporins are grouped into "generations" by their antimicrobial properties. First-generation cephalosporins are mainly active against Gram-positive bacteria, whereas, later cephalosporins (i.e. second-, third- and fourth-generation cephalosporins) have extended-spectrum of antimicrobial activities. Each newer generation of cephalosporins has significantly greater antimicrobial properties against Gram-negative bacteria than the preceding generation, and in most cases with decreased activity against Gram-positive organisms. Fourth-generation cephalosporins, however, have broad-spectrum activity, and are highly active against both Gram-positive and Gram-negative microorganisms (Llarrull et al 2010).

Cephalosporins contain a  $\beta$ -lactam-ring which is fused to an expanded five-membered sulfur-containing ring and side chains (**Fig. 1.11**). Side chain modifications have led to the development of four generations of cephalosporins. The modified side chains of the cephalosporins allow the drugs to penetrate the cell envelope through the porins of Gram-negative outer membranes while retaining high affinities against its targets – penicillin binding proteins (PBPs). The side chain modifications also increase resistance of cephalosporins to  $\beta$ -lactamase attack, resulting in less susceptible of cephalosporins to penicillinases than penicillins. Cephalosporins bind to PBPs and inhibit peptidoglycan crosslinking by the PBP enzymes, resulting in inhibition of the final transpeptidation step in the synthesis of the peptidoglycan (Zapun et al 2008; Walsh et al 2003).

Currently third-generation cephalosporins ceftriaxone and cefixime are recommended for the treatment of uncomplicated gonorrhoea (Workoski et al 2008). There have been few reports of clinical treatment failures caused by third-generation cephalosporins (Tapsall 2009a/b; Barry & Klausner 2009). However, *N. gonorrhoeae* isolates exhibiting reduced susceptibility were observed in a variety of countries (Tapsall 2009a/b; Barry & Klausner 2009).

Reduced susceptibility of *N. gonorrhoeae* isolates to third-generation cephalosporins is mediated via mutations in the products of various chromosomal genes involving chromosomally-mediated penicillin resistance (Barry & Klausner 2009). Noticeably, a mosaic-like PBP2, first identified as PBP2 mutation Pattern X (Ameyama et al 2002), may cause increased MICs to cefixime or ceftriaxone ( $\geq 0.25$  mg/L) in *N. gonorrhoeae* isolates (Ameyama et al 2002; Ito et al 2005; Takahata et al 2006). Specific mutations such as A501V and G545S in the transpeptidase domain of PBP2 have been identified to be associated with reduced susceptibility to cefixime or ceftriaxone in *N. gonorrhoeae* isolates (Takahata et al 2006; Osaka et al 2008).

PBP1 protein with a L421P mutation which resulted in high-level penicillin resistance (Ropp et al 2002), has been noted in clinical *N. gonorrhoeae* isolates with reduced susceptibility to third-generation cephalosporins (Ropp et al 2002; Shigemura et al 2005; Lindberg et al 2007). Recently, mutations in the DNA binding domain of MtrR or within the *mtrR* promoter region have been associated with reduced susceptibility of *N. gonorrhoeae* to third-generation cephalosporins (Tanaka et al 2006; Tapsall 2009a/b). G120K/A121D mutations in PorB are also associated with decreased susceptibility of *N. gonorrhoeae* isolates to third-generation cephalosporins, in addition its association with penicillin resistance (Tapsall 2009a/b).

The mechanisms behind reduced susceptibility or resistance to third-generation cephalosporins in *N. gonorrhoeae* are not well understood. Plasmid-mediated resistance to third-generation cephalosporins in *N. gonorrhoeae* has not been reported (Barry & Klausner 2009). Chromosomal alterations in the *porB*, *mtrR*, *penA* and *ponA* genes may be simultaneously involved, and unknown alterations in other genes may also play roles (Barry & Klausner 2009).

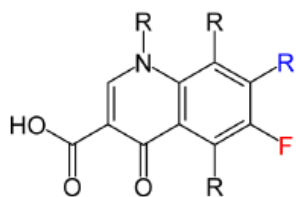
### 1.3.2. Quinolones

Quinolones are synthetic molecules used as antibiotics to combat infections (Blondeau 2004). Quinolone drugs have evolved through 4 generations based on chemical modifications of the 4-quinolone skeleton (Smith et al 2001), from its first developed molecule nalidixic acid (**Fig. 1.13**). The second generation quinolones are fluorinated, including norfloxacin, ciprofloxacin and Ofloxacin (Ball 2000). Third-generation quinolones include levofloxacin. Further modifications of the 3<sup>rd</sup> generation molecules result in the fourth generation quinolones such as gatifloxacin and moxifloxacin (Blondeau 2004; Blondeau & Missaghi 2004). Generation II, III, and IV quinolones each contain a fluorine atom attached to the nucleus at position 6, and are all known as fluoroquinolones. Ciprofloxacin was commonly used for the treatment of gonorrhoea in the 1990s (Workoski et al 2008).

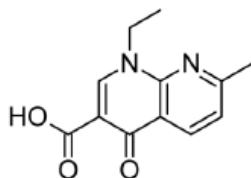
Fluoroquinolones display bactericidal activities by inhibiting the prokaryote-specific enzymes DNA gyrase and topoisomerase IV (Blondeau 2004). Subsequently, bacterial DNA synthesis is blocked and bacterial cell death rapidly occurs (Khodursky et al 1995; Marlans & Hiasa 1997). In *N. gonorrhoeae*, DNA gyrase (GyrA, encoded by *gyrA*) is the primary target and topoisomerase IV (ParC, encoded by *parC*) the secondary target (Belland et al 1994).

Mutations at key sites in GyrA and ParC - the quinolone resistance-determining region (QRDR; **Fig. 1.14**) can decrease their binding affinity to fluoroquinolones, reducing the drug's effectiveness in *N. gonorrhoeae* (Belland et al 1994; Deguchi et al 1996). QRDR is one of most well-characterized CMR mechanisms in *N. gonorrhoeae*. Key amino acid substitutions occur at the codons Ser-91 and Asp-95 in GyrA and Asp-86 or Ser-87 in ParC (Trees et al 1999; Ng et al 2002a; Su et al 2001; Tanaka et al 2001). Various other mutations have been also reported (Trees et al 1999; Giles et al 2004; Tanaka et al 2000b).

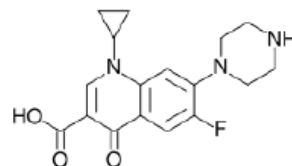
Plasmid-mediated resistant genes produce proteins that can bind to DNA gyrase, protecting it from the action of quinolones (Martínez-Martínez et al 2008). These confer the so-called transferable fluoroquinolone resistance in Gram-negative and Gram-positive bacteria (Martínez-Martínez et al 1998, 2008). In *N. gonorrhoeae*, plasmid-mediated quinolone resistance has not been reported.



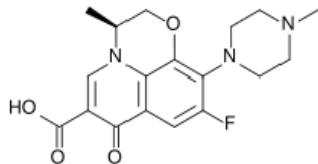
Fluoroquinolone backbone



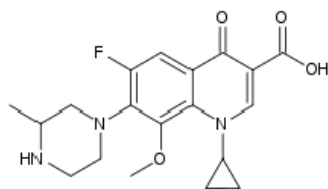
Nalidixic acid



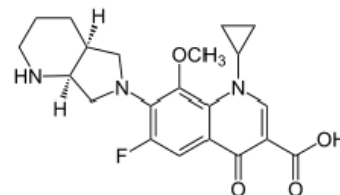
Ciprofloxacin



Levofloxacin

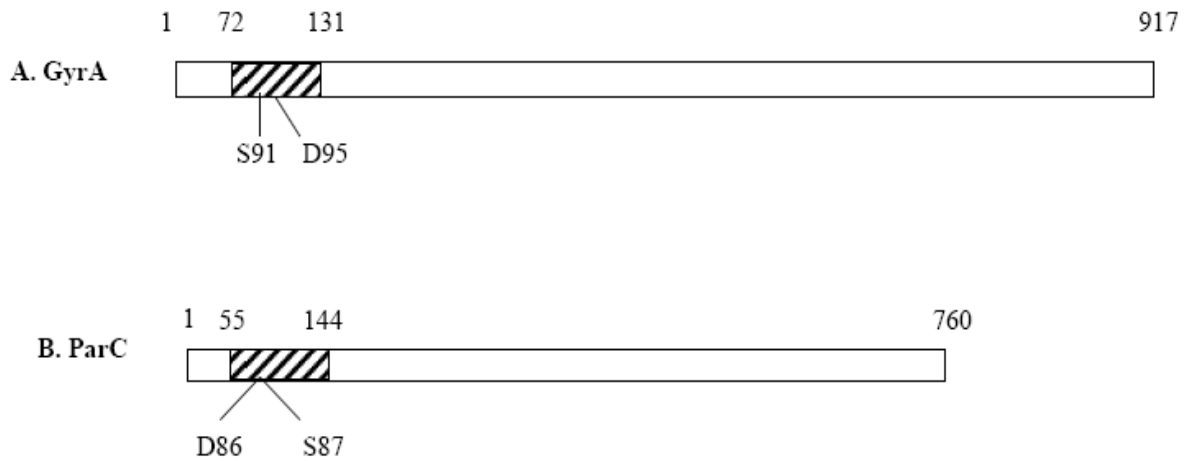


Gatifloxacin



Moxifloxacin

**Fig. 1.13 Structure of Quinolone Antibiotics.** Quinolones are divided into four generations based on their antibacterial spectrum. Nalidixic acid – first generation, ciprofloxacin – second generation, levofloxacin – third generation, gatifloxacin and moxifloxacin – fourth generation. F-fluorine. Adapted from the Wikimedia website (<http://en.wikipedia.org/wiki/Quinolone#First-generation>), accessed in March 2011.



**Fig. 1.14 Schematic Presentation of Quinolone Resistance Determinant Regions (QRDRs) in GyrA (A) and ParC (B) in *N. gonorrhoeae*.** Hatched regions represent QRDRs of GyrA and ParC (Belland et al 1994; Trees et al 1998). Amino acid positions are shown above the bars. Amino acids frequently mutated in ciprofloxacin resistant isolates are indicated.

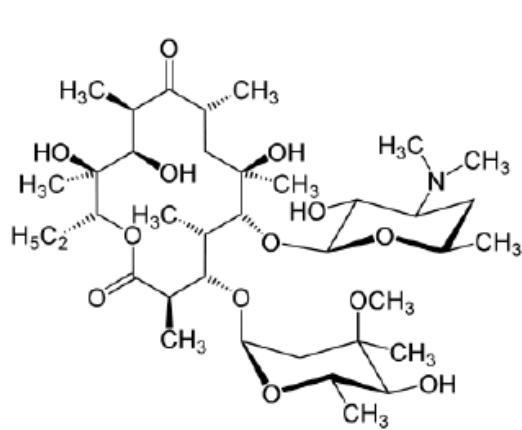
### 1.3.3 Macrolides: Erythromycin and Azithromycin

Macrolides are composed of at least two amino or neutral sugars attached to a large lactone ring of variable size according to the compound (**Fig. 1.15**). Erythromycin has a 14-membered ring and azithromycin has a 15-membered ring (Walsh et al 2003). Macrolides are bacteriostatic.

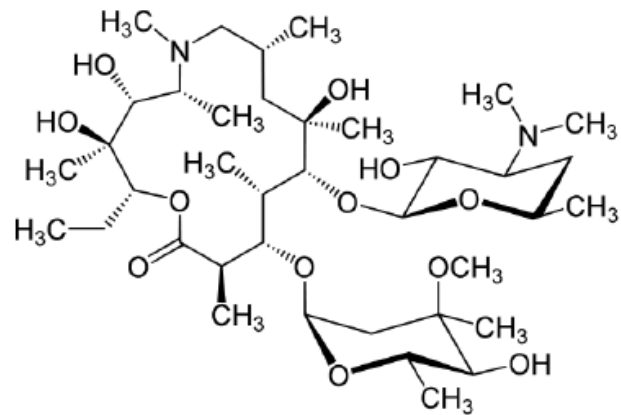
Erythromycin binds to the 50S subunit of the bacterial ribosome, blocking extension of the peptide chain by steric hindrance, and stimulates dissociation of peptidyl-tRNA. It also blocks assembly of the 50S subunits through its interaction with 23S rRNA. Azithromycin has extended-spectrum antimicrobial activities against Gram-positive and Gram-negative microorganisms and has a similar mode of action to erythromycin. Erythromycin had been used for the treatment of gonorrhoea in cases where penicillin or quinolones are contradicted such as penicillin-allergy or pregnancy. Azithromycin is still a recommended first-line drug for the treatment of gonorrhoea in some regions or in cases where cephalosporins are contradicted (Workoski et al 2008). Azithromycin has also been used in treating co-infections of *N. gonorrhoeae* and *Chlamydia trachomatis* (PHAC 2006).

Gonococcal resistance to macrolides is mediated by mutation of RNA or ribosomal proteins. The *erm* genes encode erythromycin ribosome methylases, which are carried by plasmids or transposons (Trees et al 1999). Mutations in the ribosomal genes 16S rRNA or the 23S rRNA *rrl* gene are associated with resistance of *N. gonorrhoeae* to azithromycin and erythromycin (Ng et al 2002b; Roberts et al 1999, 2004; Chisholm et al 2009, 2010; Galarza et al 2009, 2010). Single mutations in 23S rRNA have been associated with high-level resistance to azithromycin (Chisholm et al 2009, 2010; Galarza et al 2009, 2010).





Erythromycin



Azithromycin

**Fig. 1.15 Structure of Erythromycin and Azithromycin.** Adapted from the Wikimedia website (<http://en.wikipedia.org/wiki/Azithromycin>), accessed March 2011.

### 1.3.4 Tetracyclines

Tetracyclines (tetracycline and doxycycline) contain four hydrocarbon rings (**Fig. 1.16**) and are bacteriostatic. They bind to the 30S ribosomal subunit inhibiting protein biosynthesis (elongation). Tetracyclines have been used for treatment of genital chlamydial infections or in combination with anti-gonococcal antibiotics for the treatment of co-infections in gonorrhea patients (CDC 2010; WHO 2003).

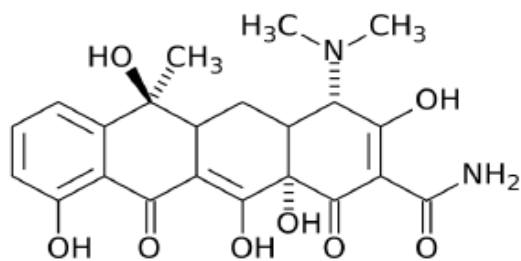
Gonococcal resistance to tetracyclines can be mediated by *tetM*-containing plasmids, causing high levels of resistance to this class of antibiotics, i.e. TRNG (Dillon & Pagotto 1999). TRNG is associated with *tetM* determinant-containing plasmids which were created in nature as the result of the insertion of a *tetM*-like sequence into the endogenous gonococcal conjugative plasmid (Morse et al 1986; Swartley et al 1993; Greco et al 2003). The *tetM* determinant was originally described in *Streptococcus* species as a mobile, transposon-borne element which causes the release of tetracycline from the ribosome. In some cases, the *tetM* determinant is located on the chromosome in both *N. gonorrhoeae* and other species (Morse et al 1986; Swartley et al 1993).

Mutations in the *rpsJ* gene of the gonococcal chromosome and *porB* types are also associated with tetracycline resistance in *N. gonorrhoeae* (Hu et al 2005; Liao et al 2008).

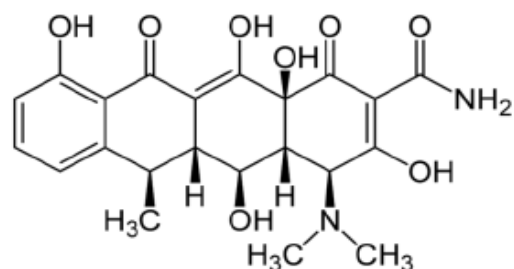
### 1.3.5 Spectinomycin

Spectinomycin (**Fig. 1.16**) is an aminocyclitol antibiotic, closely related to the aminoglycosides and is a bacteriostatic agent. It acts on the 30S ribosomal subunit, inhibiting translocation of the peptidyl tRNA. It is recommended for the treatment of gonorrhea in individuals that have documented cephalosporin allergy and are pregnant or are strongly suspected to have fluoroquinolone resistant gonorrhea (WHO 2003).

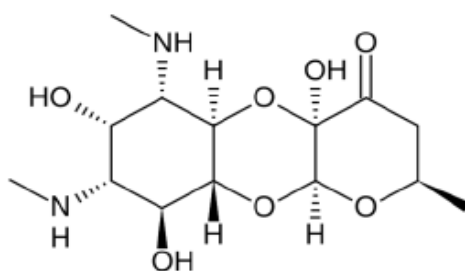
Mutations in 16S rRNA *N. gonorrhoeae* are associated with resistance to spectinomycin (Galimand et al 2000). Mutations of ribosomal protein S5 preventing the ribosome from spectinomycin binding has also been reported (Kehrenberg & Schwarz 2007).



Tetracycline



Doxycycline



Spectinomycin

**Fig. 1.16 Structure of Tetracyclines, Doxycycline and Spectinomycin.**

Adapted from the Wikimedia websites (<http://en.wikipedia.org/wiki/Spectinomycin>; <http://en.wikipedia.org/wiki/Tetracycline>; <http://en.wikipedia.org/wiki/Doxycycline>), accessed March 2011.

## 1.4 Molecular Typing and Molecular Epidemiology in *Neisseria gonorrhoeae*

### 1.4.1 Overview of Molecular Typing Methods for *N. gonorrhoeae*

A number of phenotypic and genotypic typing methods have been developed for use in the epidemiology of infectious diseases to distinguish isolates. These methods have been applied to the molecular epidemiology of gonorrhea (Sarafian and Knapp 1989; Unemo & Dillon 2011; **Table 1.2**).

Index of discrimination (ID) has been used to characterize discriminatory abilities of typing methods. ID indicates the probability of a typing method to differentiate two different isolates (Hunter & Gaston 1988). An ID of higher than 90% has been considered to be sufficient in differentiating *N. gonorrhoeae* isolates (Dillon et al 1993).

#### 1.4.1.1 Phenotypic Differentiation of *N. gonorrhoeae* Isolates

The phenotypic characterizations of *N. gonorrhoeae* (Unemo & Dillon 2011) have included auxotyping (A) (Carifo & Catlin 1973; Ng & Dillon 1993), serovar determination (S) (Knapp et al 1984; Sandström et al 1982, 1984; Dillon et al 1987a/b), and the combination of A/S (Ng & Dillon 1993), as well as antibiogram determination, or a combination of these methods (Ng et al 1995).

**Antibiogram:** Antibiogram determinations are used for monitoring antibiotic susceptibility and for determining appropriate treatment recommendations (Dillon et al 1978b, 1990; Dillon & Pagotto 1999). The discriminatory power of antibiograms is low, and this limits their usefulness for isolate differentiation. Antibiograms are inappropriate for epidemiological studies of gonorrhea (Ng et al 1995; Dillon et al 1993).

**Table 1.2 Characteristics of Typing Methods Used in Differentiating *N. gonorrhoeae* Isolates<sup>§</sup>**

Method	Principles/Targets	ID	RP	EI	EU	Labor intense	Cost
Antibiogram	Antimicrobial susceptibility profiles	Low	High	Moderate to high	High	High	Moderate
Auxotyping (A)	Nutritional requirements	Low	High	Moderate	Moderate	High	Moderate
Serovar typing (S)	Detection of outer membrane proteins using monoclonal antibodies	Moderate	High	Moderate	Low	High	High
A/S	Combination of A & S	High	High	Moderate	Low	High	High
45 MLEE	Electrophoresis of house-keeping proteins	Moderate	Moderate	Moderate	Moderate	Moderate	Moderate to high
Plasmid profiles	Drug resistance plasmids based on size or PCR amplification	Low	Moderate to high	Moderate to high	High	Moderate	Low
Ribotyping	Restriction endonuclease (RE) digestion and use of ribosomal RNA probes	Low	Low to moderate	Moderate	Moderate	Moderate	Moderate
PFGE	Large chromosomal DNA fragments of RE digestion separated by pulsed field gel electrophoresis	High	Moderate	Moderate	Low	Moderate	Moderate
Opa typing	PCR amplification of <i>opa</i> loci and observation of banding patterns on agarose gel	High	Moderate	Moderate	Low to moderate	Moderate	Moderate

Lip-typing	PCR amplification and DNA sequences of repeats in lipoprotein coding sequences	Moderate	High	Moderate to high	High	Low	Low
MLST	DNA sequences of internal fragments of housekeeping genes	Moderate to high	High	Moderate to high	Moderate to high	Low to moderate	Moderate
porB-based	DNA sequences of porB (full- or extended-length)	High	High	High	High	Low	Low
NG-MAST	DNA sequences of fragments of porB and tbpB	High	High	High	High	Low	Low

§: Modified from Unemo & Dillon 2011, in press.

46

ID: Index of discrimination

RP: Reproducibility

EI: Ease of interpretation

EU: Ease of use

MLEE: Multiple locus enzyme electrophoresis

PFGE: Pulsed field gel electrophoresis

MLST: Multilocus sequence typing

NG-MAST: *Neisseria gonorrhoeae* multi-antigen sequence typing

**Auxotyping (A):** Auxotyping is based on nutritional requirements of *N. gonorrhoeae* isolates. Some nutritional components (e.g. cystine, cysteine) are required for all isolates of *N. gonorrhoeae*, whereas various other components are required by some but not all isolates. Auxotyping differentiates *N. gonorrhoeae* isolates into various nutrient-requiring phenotypes, e.g. non-requiring (NR) or prototrophic, proline-requiring (P), arginine-hypoxanthine-uracil-requiring (AHU), and proline-citrulline-uracil-requiring (PCU) (Ng et al 1995). This method is labour-intensive and is insufficient in discriminatory ability (Dillon et al 1987b, 1993).

**Serotyping (S) and A/S typing:** Serotyping is based on the antigenic diversity of the major outer membrane porin proteins, known as the protein I (PI) molecules or PorB (Sandstrom et al 1982). Building on earlier typing schemes using polyvalent antibodies against whole gonococcal proteins or partially purified protein PI (Sandstrom and Danielsson 1980, Buchanan and Hildebrandt 1981), typing schemes based on monoclonal antibodies (MAbs) against PI were developed (Knapp et al 1984). One of these typing systems is the use of the Genetic system (GS) series of MAbs (Knapp et al 1984). Another set of PI-specific MAbs was designed as the Ph panel (Pharmacia; Bygdeman et al 1983; Kohl et al 1990). The utilization of the series of the MAbs produces serotyping schemes with high discriminatory ability, especially when it is used in combination with auxotyping methods (Dillon et al 1987a/b, 1990, 1993). However, the use of this approach is limited by inconsistency in the interpretation of weak reactions, the inaccessibility to the MAbs, and the prevalence of non-serotypeable strains (Unemo et al 2003).

**Multiple Locus Enzyme Electrophoresis (MLEE):** MLEE indexes allelic variations based on banding patterns of multiple housekeeping enzymes (Ng & Dillon 1993; De la Fuente & Vazquez 1992). MLEE has low discriminatory power if clones are being examined, and can be difficult to interpret due to differences in cultural growth conditions and enzyme productivity. This method is very laborious. The MLEE method is the “ancestor” of the multilocus DNA sequence typing method (MLST) and has largely been replaced by MLST for all bacterial species.

#### 1.4.1.2 Genotypic Differentiation of *Neisseria gonorrhoeae* Isolates

Molecular typing techniques (Table 1.2, page 45) have been developed and used in molecular epidemiology to address epidemiologic problems in infectious diseases. The factors for evaluating applicability of molecular typing methods to epidemiology include simplicity, high throughput, low cost, and appropriateness as compared to conventional methods (Riley 2004). Selection for molecular typing systems is based on typeability, reproducibility, ease of interpretation, ease of use, and high discriminatory power (Maslow et al 1993).

Methods of DNA sequence analysis are reproducible, and all strains are typeable, which facilitates inter-laboratory comparisons of results nationally and internationally. These methods have gained popularity in molecular epidemiology of gonorrhea. Methods based on DNA sequence analysis of single (*porB*) or combinations of hyper-variable loci (e.g. *porB* and *tbpB*) have become the most useful tools in short-term molecular epidemiology of *N. gonorrhoeae*.

Genotypic typing methods are dependent on analysis of chromosomal or plasmid DNA molecules (Unemo & Dillon 2011). Analysis of plasmid content includes determination of molecular weights of plasmids and banding patterns of products of PCR amplification on plasmids (Dillon et al 1987b; Dillon & Carballo 1990; Ison et al 1993; Greco et al 2003). Restriction endonuclease (RE) analyses of whole chromosomal genomes include ribotyping, RE analysis using pulsed-field gel electrophoresis (PFGE; Li & Dillon 1995; Ng & Dillon 1993; Poh et al 1995a/b). Analysis of banding patterns of PCR products of multiple loci of gonococcal genome includes Opa-typing (O'Rourke et al 1995) and Lip-typing (Trees et al 2000).

DNA sequence-based typing of single or multiple loci has been widely used such as *porB*-based typing (Viscidi et al 2000; Unemo et al 2002, 2003). *Neisseria gonorrhoeae*-multiantigen sequence typing (NG-MAST; Martin et al 2004), and Multilocus Sequence Typing (MLST; Maiden et al 1998; Maiden 2006; Viscidi & Demma 2003).

**Plasmid Content Analysis:** Most gonococcal strains carry a 4.2-kilobase pair plasmid (2.6 megadalton, MDa) and a 24.5 MDa transfer plasmid (Sox et al 1978). Plasmid analysis has been



used to differentiate plasmid-mediated antimicrobial resistance including penicillinase-producing *N. gonorrhoeae* (PPNG) and plasmid-mediated tetracycline resistant *N. gonorrhoeae* (TRNG) (Dillon & Yeung 1989; Ison et al 1993, Xia et al 1995; Greco et al 2003).

Penicillinase production in the plasmids carried by PPNG isolates is mediated by a TEM1-type  $\beta$ -lactamase which is encoded by the TnA transposon Tn2 (Chen and Clowes 1987; Fayet et al 1982). The family of gonococcal  $\beta$ -lactamase-producing plasmids is genetically related (Dillon & Yeung 1989; Roberts 1989). Six plasmid types have been described, i.e. Asia- (generally reported as 4.2– 4.4 MDa), Africa- (3.2 MDa), Toronto- (3.05 MDa), Rio- (2.9 MDa), Ni<sup>^</sup>mes- (3.8 MDa), and New Zealand- types (6.5 MDa) (Brett 1989; Dillon & Yeung 1989; Gouby et al 1986; Yeung et al 1986). A number of studies, based on restriction endonuclease analysis, hybridization analysis, and heteroduplex analysis by electron microscopy have shown that the Africa-, Toronto-, Ni<sup>^</sup>mes-, Rio-, and New Zealand- type plasmids are deletion or insertion derivatives of the prototype Asia-type plasmid (Gouby et al 1986; Yeung et al 1986). Recently, a new type of  $\beta$ -lactamase-producing plasmid was identified gonococcal isolates from South Africa (Fayemiwo et al 2010).

TRNG is associated with the presence of a 25.2-MDa *tetM*-containing plasmid (TetM plasmid). This plasmid was created in nature as the result of the insertion of a *tetM*-like sequence into the endogenous gonococcal 24.5-MDa conjugative plasmid (Morse et al 1986). Using restriction endonuclease analysis, *tetM*-containing plasmids in *N. gonorrhoeae* were classified as either American type (first originating in the United States) or Dutch type (first originating in the Netherlands) (Gascoyne-Binzi et al 1991). The Uruguay TetM type exhibits a unique restriction pattern, and its amplimer demonstrates 100% identity with a *tetM*-containing plasmid from *N. meningitidis* (Marquez et al 2002).

PCR-based plasmid typing methods have been developed for rapidly detecting and differentiating  $\beta$ -lactamase producing plasmids of PPNG isolates (Dillon et al 1999) and *tetM*-containing plasmids of TRNG isolates (Xia et al 1995). These methods are easy to perform and are useful for investigating antimicrobial resistance and outbreak of plasmid-harboring *N. gonorrhoeae* strains; however, the discriminatory power of plasmid typing is low (Dillon et al

1993).

**Ribotyping:** Ribotyping (Li & Dillon 1995; Ng & Dillon 1993) utilizes techniques of restriction endonuclease (RE) analysis and . In RE analysis, chromosomal DNA is cleaved with type II restriction endonucleases producing a unique set of DNA fragments for each chromosome. The resulting restriction fragment length polymorphisms (RFLP) were analyzed by gel electrophoresis. Ribotyping involves the digestion of the bacterial genome, electrophoresis, and visualization of the resulting banding patterns after hybridization with a ribosomal RNA probe (rRNA) (Pace et al 1986). Ribotyping has been used in studying strain distribution of *N. gonorrhoeae* (Ng & Dillon 1993). However, ribotyping is laborious and has a low discriminatory power (Unemo & Dillon 2011).

**Pulsed Field Gel Electrophoresis (PFGE):** PFGE improves resolution of DNA fragments by repeatedly changing the orientation of the electric field in gel electrophoresis. It can resolve DNA fragments ranging in size up to 2000 kb (Li & Dillon 1995; Sor 1988). This method makes use of low-frequency cutting REs in comparative analysis of RFLP (Li & Dillon 1995; Ng et al 1995; van Looveren et al 1999). PFGE has a high discriminatory power. Major limitations of PFGE, however, include laboriousness and difficulties if not impossibility of comparing results between laboratories.

**Opa-typing:** Opa-typing involves analysis of up to 11 *opa* genes coding for the neisserial colony opacity-associated (Opa) proteins (O'Rourke et al 1995; Palmer et al 2001; Ison 1998; Ward et al 2000). In Opa-typing, *opa* genes are PCR-amplified; PCR products are subjected to RE digestion; banding patterns are compared after gel electrophoresis (O'Rourke et al 1995). Opa-typing has a high discriminatory power and has been used in tracking strain transmission and strain clustering in *N. gonorrhoeae* (O'Rourke et al 1995). Major limitations of Opa-typing, however, are laboriousness, and the difficulty in standardizing results and in comparing banding patterns between laboratories.

**Lip-based DNA Sequence Typing:** Lip-typing (Trees et al 2000) characterizes the number and sequences of repeats (encoding a five amino acid sequence, AAEAP) in the gene encoding an outer membrane lipoprotein (Woods et al 1989). By PCR amplifying the *lip* gene and

subsequently differentiating the sizes of PCR products, the number of the repeat-coding sequences can be predicted. DNA sequence analysis of the amplicons further differentiates *N. gonorrhoeae* strains with the same number of repeats, thus identifying Lip subtyping patterns (Trees et al 2000). The discriminatory ability of this method remains to be assessed.

**Multiple Locus Sequence Typing (MLST):** MLST evolved from the MLEE phenotypic typing method (De la Fuente & Vazquez 1992). MLST typing scheme for *N. gonorrhoeae* was originally adapted from MLST for *N. meningitidis* (Viscidi & Demma 2003; Maiden et al 1998). A slight modification of the “meningitidis” scheme with addition of one gene has been used for molecular epidemiology of *N. gonorrhoeae* (Bennet et al 2007). A similar MLST scheme targeting seven loci (*fumC*, *gdh*, *glnA*, *gnd*, *pilA*, *pyrD* and *serC*) has been used in studying gonococcal population dynamics (Viscidi & Demma 2003; Tazi et al 2010). MLST typing is most useful for studying bacterial genomic evolution and bacterial populations (Viscidi & Demma 2003) since the house-keeping genes are under neutral selection and evolve slowly (Pérez-Losada et al 2005).

Recent work from the Dillon laboratory improved the resolution of gonococcal MLST by altering targeted loci, which has been shown to have high discriminatory abilities and abilities to identify geographic clusters and outbreaks (Vidovic et al 2010), indicating its usefulness in both short- and long-term molecular epidemiology of *N. gonorrhoeae* (Unemo & Dillon 2011).

**porB-based DNA Sequence Typing:** porB-based DNA sequence typing is the analysis of the entire or a segment of the *porB* gene (Viscidi et al 2000; Unemo et al 2002). This method has high discriminatory power when extended length or full-length *porB* sequences are used (Unemo & Dillon 2011). The cost for using this method is low as compared to other DNA sequence-based methods. It has been used to trace the transmission of individual *N. gonorrhoeae* strains within a community, to identify suspected clusters of cases of gonorrhea, and to confirm the epidemiological connection of patients (Hobbs et al 1999; Unemo et al 2002; Viscidi & Demma 2003).

***Neisseria gonorrhoeae* Multi-Antigen Sequence Typing (NG-MAST):** NG-MAST involves the analysis of two highly variable loci, *porB* and *tbpB* (Martin et al 2004). NG-MAST

has been used to confirm sexual contacts and trace strain transmission in geographically localized communities (Choudhury et al 2006; Bilek et al 2007). The combination of two hypervariable loci establishes that NG-MAST has a very high discriminatory power. A database is available for researchers to compare sequence types of *N. gonorrhoeae* isolates from different laboratories and geographical areas (<http://www.ng-mast.net>, accessed 20 December 2010).

**Whole Genome Sequencing of *N. gonorrhoeae*:** Comparative genome analysis for differentiating *N. gonorrhoeae* strains is at its “infant” stage (Unemo & Dillon 2011). Up to date (July 30, 2010), the genomes of two *N. gonorrhoeae* strains have been completely sequenced: *N. gonorrhoeae* FA1090, NCCP11945 and TCDC-NG08107. The genome of *N. gonorrhoeae* FA1090 (GenBank Accession #AE004969) is 2.153922 million nucleotides (Mbp) in length with a GC content of 52.0%. There are 2002 protein-coding sequences and 67 structural RNA-coding sequences in the *N. gonorrhoeae* FA1090 genome. Sequencing of the *N. gonorrhoeae* NCCP11945 genome was completed in July 2008 (Chung et al 2008); it contains 2.232023 Mbps with a GC content of 52.0% (GenBank Accession # CP001050). There are 2662 protein-coding sequences and 67 structural RNA-coding sequences in the *N. gonorrhoeae* NCCP11945 genome.

Ongoing *N. gonorrhoeae* genome sequencing projects as of June 2010 utilize 14 *N. gonorrhoeae* strains (**Table 1.3**). According to the drafted genome data (<http://www.ncbi.nlm.nih.gov/genomeprj/23>), the genome of *N. gonorrhoeae* F62 (GenBank Accession #ADAA00000000), which was used as a reference strain, contains 2.11661 Mbps with a GC content of 52.0%. There are 2078 protein-coding sequences and 48 structural RNA-coding sequences in the *N. gonorrhoeae* F62 genome. The other 13 *N. gonorrhoeae* strains used in the ongoing genome project included clinical isolates from patients with gonococcal pelvic inflammatory diseases (n=4) or from disseminated gonococcal infections (n=4). Two antimicrobial resistant isolates used in the genome project had a reduced susceptibility to third-generation cephalosporins and were resistant to penicillin and tetracycline, respectively (n=2). Some other widely used experimental strains were also included (i.e. *N. gonorrhoeae* 1291, FA19 and MS11; n=3).

To date, four *N. gonorrhoeae* plasmids have been completely sequenced, i.e. pJD4 (Pagotto et al 2000), pSJ5.2 (Scharbaai-Vázquez et al 2007), pCmGFP (GenBank Accession #FJ172221) and pNGK (GenBank Accession #CP001051). These plasmids had lengths of 7.4 (pJD4), 5.16 (pSJ5.2), 6.1 (pCmGFP), and 4.2 kbp (pNGK), respectively. The GC contents were variable, ranging from 38% to 51%.

**Table 1.3 Current Genome Sequencing Projects in *N. gonorrhoeae*†**

<i>N. gonorrhoeae</i> strain/plasmid name	Strain source/characteristics	GenBank accession number	Length (Mbp)	GC content	# of proteins*	# of RNAs**	Project status§
<i>N. gonorrhoeae</i> FA1090	Serum-resistant, proline-requiring, isolated from a patient with disseminated gonococcal infection (DGI)	AE004969	2.15392	52.0%	2002	67	Complete
<i>N. gonorrhoeae</i> NCCP11945	Multiple drug resistant, isolated from vaginal smears in Korea	CP001050	2.23203	52.0%	2662	67	Complete
<i>N. gonorrhoeae</i> F62	Used for comparative genome analysis	ADAA000000000	2.11661	52.0%	2078	48	Draft assembly
<i>N. gonorrhoeae</i> 1291	Extensively used in studies of gonococcal pathogenesis	ABZF000000000	2.03323	51.0%	2110	42	Draft assembly
<i>N. gonorrhoeae</i> 35/02	Serovar IB-1, reduced susceptibility to cefixime and ceftriaxone, isolated in Sweden	BAZG000000000	2.04374	51.0%	2131	46	Draft assembly
<i>N. gonorrhoeae</i> DG118	DGI isolate	ABZH000000000	2.03591	52.0%	2137	49	Draft assembly
<i>N. gonorrhoeae</i> DG12	DGI isolate	ACIG000000000	2.09393	51.0%	2352	48	Draft assembly
<i>N. gonorrhoeae</i> FA19	Penicillin susceptible	ABZJ000000000	2.09989	51.0%	2183	46	Draft assembly
<i>N. gonorrhoeae</i> FA6140	Resistant to penicillin and tetracycline, isolated in North Carolina USA	ABZI000000000	2.03396	52.0%	2144	49	Draft assembly
<i>N. gonorrhoeae</i> MS11	A widely used experimental strain	ABZK000000000	2.09815	51.0%	2263	49	Draft assembly

<i>N. gonorrhoeae</i> PID1	A cervical isolate from a case of pelvic inflammatory disease (PID)	ABZM00000000	2.09132	51.0%	2267	49	Draft assembly
<i>N. gonorrhoeae</i> PID18	A cervical isolate from a case of PID	ABZL00000000	2.08326	51.0%	2235	46	Draft assembly
<i>N. gonorrhoeae</i> PID24-1	A cervical isolate from a case of PID	ABZN00000000	2.03375	52.0%	2144	46	Draft assembly
<i>N. gonorrhoeae</i> PID332	A cervical isolate from a case of PID	ABZO00000000	2.10185	51.0%	2265	46	Draft assembly
<i>N. gonorrhoeae</i> SK-92-679	An isolate from the blood of a patient with DGI	ABZP00000000	2.06828	51.0%	2218	42	Draft assembly
<i>N. gonorrhoeae</i> SK-93-1035	An isolate from the blood of a patient with DGI	ABZQ00000000	2.04937	51.0%	2200	48	Draft assembly
Plasmid pJD4	Submission: Dillon et al 1995	U20374	0.0074	38.0%	1	--	Complete
Plasmid pSJ5.2	Submission: Scharbaai-Vazquez et al 2006	DQ355980	0.00516	38.0%	3	--	Complete
Plasmid pCmGFP	Submission: Dowideit et al 2008	FJ172221	0.0061	48.0%	2	--	Complete
Plasmid pNGK	Submission: Yoo et al 2008	CP001051	0.0042	51.0%	12	--	Complete

†: Data was derived from the National Center for Biotechnology Information (NCBI) website (<http://www.ncbi.nlm.nih.gov/genomeprj/23>).

\*: Number of protein-coding genes.

\*\* : Number of structural RNA-coding genes.

§: Project status as of July 30, 2010.

### 1.4.2 Molecular Epidemiology of Gonorrhoea

The term "molecular epidemiology" was first proposed in 1973 by Kilbourne (Kilbourne 1973). The definition of molecular epidemiology has since evolved. Recently, Riley (2004) defined molecular epidemiology of infectious diseases as "the study of the distribution and determinants of infectious diseases that utilize molecular biology methods." Molecular epidemiology of infectious disease uses combinatorial approaches of molecular typing methods and epidemiology to elucidate observations made in the biological world to formulate new concepts and make predictions. Molecular epidemiology determines the dynamics of disease transmission and identifies risk factors including genetic determinants.

*N. gonorrhoeae* is highly variable in its genotype and phenotype (Fredlund et al 2004; O'Rourke et al 1995). The characteristics of variability have been exploited to differentiate gonococcal strains circulating in a given community, thereby identifying patterns of specific strain transmission and guiding control strategies (Unemo et al 2002, 2004; Viscidi et al 2000; Martin et al 2004). An objective of this study was to determine strain distributions and circulating clusters of *N. gonorrhoeae* in Shanghai using porB-based DNA sequence analysis and NG-MAST analysis as molecular typing tools.

Molecular typing methods which differentiate *N. gonorrhoeae* isolates, coupled with traditional epidemiological methods, have been used to identify circulating clusters of *N. gonorrhoeae* isolates and transmission networks (Choubury et al 2006; Ward et al 2000). DNA sequence analysis of various gene(s) is currently the method of choice for distinguishing *N. gonorrhoeae* isolates as it provides unambiguous and reproducible information, has high discriminatory power, and enables data to be stored or shared electronically, permitting reliable comparisons to be made between laboratories (Maiden 2006; O'Rourke et al 1995; Viscidi et al 2000).

porB-based DNA sequence analysis has been used for studying the molecular epidemiology of *N. gonorrhoeae* since 2000 (Bash et al 2005; Lunback et al 2006; Pérez-Losada et al 2005; Unemo et al 2002, 2003, 2004; Viscidi et al 2000) and involves sequencing either the entire gene



or various regions of *porB* (Unemo et al 2002, 2003, 2004). DNA sequence analysis of gonococcal *porB* genes can provide a high index of discrimination for isolates of *N. gonorrhoeae* (Viscidi et al 2000; Unemo et al 2003) and has been used to identify circulating strains/clusters (Unemo et al 2002, 2003; Bash et al 2005; Lynn et al 2005; Hobbs et al 1999), track strain transmission in sexual contacts (Cooke et al 1997; Unemo et al 2002; Viscidi et al 2000, 2003), and investigate antibiotic resistance (Lunback et al 2006; Olesky et al 2002, 2006).

The *N. gonorrhoeae* Multi-Antigen Sequence Typing (NG-MAST) methodology, which has been applied since 2004 (Martin et al 2004; Bilek et al 2007; Lunback et al 2006; Unemo et al 2007a/b), is based on DNA sequence analysis of two highly polymorphic loci, *porB* and *tbpB* (Martin et al 2004). The NG-MAST database, available online ([www.ng-mast.net](http://www.ng-mast.net)), allows public access for sequence submission and assignment of sequence types for either *porB* or *tbpB* individually, or for the assignment of strain types (STs) using a combination of the two loci.

## 1.5 Hypothesis and Objectives

China has experienced an increasing burden of gonorrhea and antimicrobial resistance in *N. gonorrhoeae* isolates. The expansion of international trade, and social and travel relationships in China facilitates the global diffusion of infectious agents and antimicrobial resistance. This study focused on investigating the prevalence of antimicrobial resistance and mechanisms of antimicrobial resistance in *N. gonorrhoeae* in Shanghai, China. This study also explores molecular epidemiology of gonorrhea in China.

### 1.5.1 Hypothesis

- Trends of antimicrobial resistance of *N. gonorrhoeae* in Shanghai differ temporally and geographically from Urumchi, China. Isolates with decreased susceptibility or resistance to third-generation cephalosporins are emerging;
- Specific genetic alterations in various loci are associated with gonococcal antimicrobial resistance (i.e. *gyrA* and *parC* for quinolone resistance; *porB*, *mtrR*, *penA* and *ponA* for third-generation cephalosporin resistance).
- Molecular epidemiology based on *porB* DNA sequence analysis and NG-MAST typing of *N. gonorrhoeae* isolates will reveal connected clusters of infections not identified by partner tracing or traditional epidemiological survey methods and will elucidate temporal and geographic differences between *N. gonorrhoeae* isolates;

### 1.5.2 Objectives

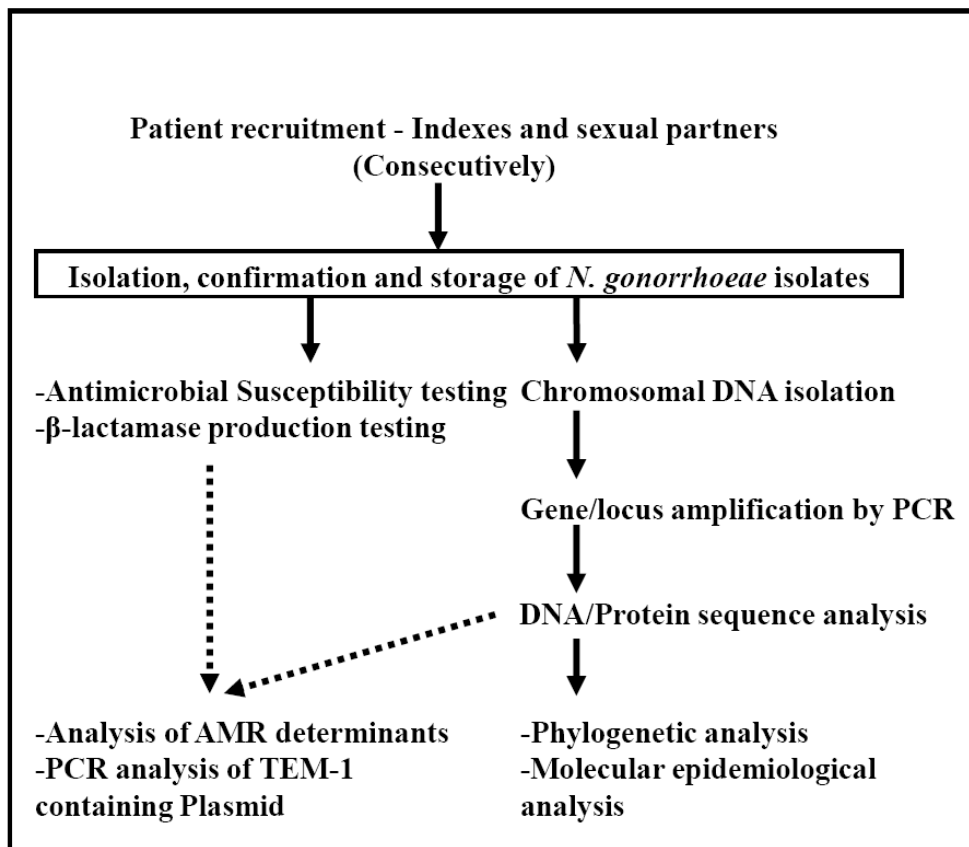
- To describe patterns and trends of antimicrobial resistance in *N. gonorrhoeae* in China by analyzing antimicrobial susceptibility profiles for isolates collected from:
  - Shanghai in 2005
  - Shanghai in 2008
  - Urumchi in 2007-2008
- To investigate the underlying molecular mechanisms of gonococcal antimicrobial resistance by analysis of:

- Quinolone resistance determinant regions (QRDR) of GyrA and ParC
- Mutations in genes/proteins potentially associated with reduced susceptibility to ceftriaxone:
  - PorB (*porB*)
  - MtrR (*mtrR*)
  - Penicillin binding protein 2 (PBP2, *penA*)
  - Penicillin binding protein 1 (PBP1, *ponA*)
- To describe the distribution of *N. gonorrhoeae* strain types in Shanghai by molecular epidemiological studies using molecular tools:
  - Refining a typing scheme of *porB*-based DNA sequence analysis
  - Strain distribution based on *porB* DNA sequence analysis
  - Strain distribution based on NG-MAST analysis
  - Association of molecular types and epidemiologically revealed sexual contacts

**CHAPTER TWO**

**METHODOLOGY**

An overview of the study design and methodology is provided in **Fig. 2.1**. In Shanghai, male gonorrhoea patients were recruited as index patients and interviewed. Sexual partners of the index patients were asked to participate and also interviewed. *N. gonorrhoeae* isolates were collected from both male and female gonorrhoea positive participants and examined for antimicrobial susceptibilities. DNA sequence analysis of targeted loci was conducted and pylogenetic analysis based on *porB* DNA sequences were carried out to determine strain distributions. Finally, molecular data were combined with information obtained in traditional epidemiological surveys to determine sexual networks and transmission patterns of gonorrhoea.



**Fig. 2.1 Overview of Methods.** This is a cross-sectional study. Recruitment of participants, *N. gonorrhoeae* isolation and identification, isolate subculture and storage, antimicrobial susceptibility testing and chromosomal DNA isolation were performed at the Shanghai Skin Disease and STD Hospital, Shanghai, China. Studies in Shanghai were conducted in 2005 and 2008, respectively. Studies in Urumchi involved collection of *N. gonorrhoeae* isolates during 2007-2008. AMR: Antimicrobial resistance. PCR: Polymerase chain reaction.

## 2.1 Epidemiological Design

### 2.1.1 Study Sites

This study used a cross-sectional design and was conducted in the Shanghai Skin Disease and STD Hospital (SSDSH) in Shanghai, China, in 2005 and 2008. To investigate the geographic distribution of gonococcal strains, *N. gonorrhoeae* isolates were also collected in 2007-2008 from Urumchi, Xinjiang Province, China.

Ethics approval was obtained from the Ottawa Hospital Research Ethics Board, Canada, the Ethics Committee of the Shanghai Municipal Bureau of Public Health, and the Ethics Office of the University of Saskatchewan, Canada. Patients' identities and isolate identities were re-assigned to make it impossible to identify individual patients from the data presented herein.

### 2.1.2 Patient Recruitment and Collection of Epidemiological Information

In Shanghai, participants were recruited and interviewed at the SSDSH. Male patients attending the SSDSH STD clinics were examined for gonococcal infections. Gonorrhea diagnosis was based on contact history, clinical manifestations, and laboratory examinations as described by the STI guidelines (Wang & Zhang 2007). Laboratory diagnosis included screening tests by Gram-stain and microscopy of urethral (male) or cervical (female) swabs, and confirmatory tests by the culture and identification of *N. gonorrhoeae* (PHAC 2006; China CDC 2007b; Wang & Zhang 2007). Male gonorrhea patients were invited to participate in the study as index patients. Consenting male index patients were administered a questionnaire by trained clinical staff. Questionnaires (**Appendix A1**) included questions on demographic characteristics and sexual behaviour. Demographic questions included information such as age and geographic area of residence, while behaviour data collected included use of condoms, type of sexual activity (i.e. oral, vaginal, or anal), dates of first and last intercourse with each named partner, and numbers of intercourse episodes.

Five of the most recent sex partners of each index patient, starting from two weeks before the onset of symptoms in the index patient, were identified by name by the index male in the questionnaire. The index patients were also asked to provide perceived demographics of their partners, such as each partner's age and mutual sexual interactions, as well as their perceptions of each partner's other sex partners. Index patients were asked to bring in their partners for examination and treatment of STIs. Partners were evaluated for symptoms and signs of STI in accordance with protocols described by PHAC and the Chinese authorities (PHAC 2006; China CDC 2007b; Wang & Zhang 2007).

Each partner attending SSDSH STD clinics was eligible for entry into the study. After informed consent was acquired, a questionnaire similar to that given to the index patients was administered to each sex partner. Cervical samples were collected and cultured for isolation of *N. gonorrhoeae*.

Because patient/partner recruitment was not successful in Urumchi, 50 *N. gonorrhoeae* isolates collected by the Xinjiang STD Centre (Urumchi) from 2007-2008 were retrieved and analyzed for antimicrobial susceptibility testing and analysis of genetic characteristics.

## **2.2 Collection, Isolation, Identification and Storage of *Neisseria gonorrhoeae* Isolates**

*N. gonorrhoeae* isolates were consecutively collected from the consenting participants with confirmed gonococcal infections at the SSDSH. Gonococcal isolates labeled SH2005 were collected over the 6-month period between November 2004 and May 2005 (n=199). The isolates labeled SH2008 were collected during the 4 month period between March 2008 and July 2008 (n=81). The Urumchi *N. gonorrhoeae* isolates were labeled UQ2008 (n=44). The UQ2008 isolates were retrieved from frozen stocks stored at the Xinjiang STD Centre (Urumchi) and were shipped to the SSDSH for subculture, confirmatory tests, and storage for subsequent analysis.

Isolation, identification, and growth of *N. gonorrhoeae* isolates were conducted in the Laboratory Diagnostic Centre of the SSDSH. Standard protocols published by the Public Health

Agency of Canada and the Chinese authorities were followed (PHAC 2006; China CDC 2007b; Wang & Zhang 2007).

Urogenital specimens were collected using sterile Dacron swabs which were streaked onto Thayer-Martin (T-M) medium (Oxoid; distributed by GuangZhou LOSO Science Ltd, Shanghai, China) supplemented with 1% IsoVitalex (Oxoid, GuangZhou LOSO Science Ltd). Inoculated T-M plates were incubated at 35<sup>0</sup>C in a humid, 5% CO<sub>2</sub> environment for 24-48 h. One or two colonies were subcultured on GC agar base (Oxoid; GuangZhou LOSO Science Ltd) supplemented with 1% IsoVitalex (GCBI) to obtain a pure *N. gonorrhoeae* culture. *N. gonorrhoeae* was identified using the oxidase test, Gram-stain and glucose utilization tests (WHO-WPR 2005; China CDC 2007b). Isolates were stored at the SSDSH at - 80<sup>0</sup>C in brain heart infusion medium (Difco; distributed by Shanghai Chemical Reagent Co, China National Medicine Group, Shanghai, China) containing 20% glycerol.

## **2.3 Antimicrobial Susceptibility Testing of *Neisseria gonorrhoeae* Isolates**

### **2.3.1 Determination of Minimal Inhibitory Concentrations**

The antimicrobial susceptibility of *N. gonorrhoeae* isolates was determined using the agar dilution method (CLSI 2006, 2009) at the Laboratory Diagnostic Centre of the SSDSH, Shanghai, China. WHO reference strains A, B, C, D and E were utilized in each susceptibility tests (CLSI 2006, 2009; WHO-WPR 2001).

Five antimicrobial agents were tested against *N. gonorrhoeae* isolates. The concentration ranges of antibiotics included: penicillin (PEN) 0.008-64.0 mg/L, tetracycline (TET) 0.008-64.0 mg/L, ciprofloxacin (CIP) 0.002-64.0 mg/L, spectinomycin (SPT) 2.0-256.0 mg/L, and ceftriaxone (CRO) 0.002–2.0 mg/L (**Table 2.1**). Antimicrobial agents were purchased from Sigma-Aldrich (Distributor: the Shanghai ANPEL Scientific Instrument Co. Ltd., Shanghai, China). Each MIC determination was performed in duplicate, and included WHO reference strains A, B, C, D and E for each test (Ye et al 1994, 2004; WHO-WPR 2001). The MIC testing was performed on GC agar base (Oxoid; GuangZhou LOSO Science Ltd) supplemented with 1% IsoVitalex (GCBI).



**Table 2.1 Determination of Minimal Inhibitory Concentrations and Interpretation Criteria for *N. gonorrhoeae*<sup>§</sup>**

Antimicrobial agent	Antibiotic concentration Testing range (mg/L)	Interpretative criteria (mg/L)		
		S	I	R
Penicillin	0.008 – 64.0	≤ 0.06	0.12 – 1.0	≥ 2.0
Tetracycline	0.008 – 64.0	≤ 0.25	0.5 – 1.0	≥ 2.0
Ciprofloxacin	0.002 – 64.0	≤ 0.06	0.12 – 0.5	≥ 1.0
Ceftriaxone	0.002 – 2.0	≤ 0.25	ND	ND
Spectinomycin	2.0 – 256.0	≤ 32.0	64.0	≥ 128.0

§: Clinical Laboratory Standards Institute (CLSI 2006, 2009)

S: Susceptible.

I: Intermediately susceptible.

R: Resistant.

ND: Not defined.

Gonococcal inocula were prepared by suspending an overnight culture grown on GCBI plates in brain heart infusion medium (Difco) to a 0.5 McFarland turbidity standard (Remel, Lenexa KS, USA), which equilibrates to  $10^8$  colony forming units (CFU) per milliliter. This suspension was diluted 1:10 with 0.9% saline, resulting in a cell density of  $\sim 10^7$  CFU/mL. Approximately 2  $\mu$ L of the cell suspension was delivered onto antibiotic-containing and control GCBI plates using a multispot inoculator (A400 Denley, England). Thus approximately  $2 \times 10^4$  cells were delivered for each inoculation spot. Inoculated plates were incubated for 18-24 hours as described in Section 2.2. MICs were done in duplicate and the MIC was determined to be the lowest concentration of an antibiotic producing complete inhibition of growth.

### 2.3.2 Determination of Plasmid-mediated Resistance in *N. gonorrhoeae* Isolates

$\beta$ -lactamase production of *N. gonorrhoeae* (PPNG) isolates was determined using the chromogenic cephalosporin test (Oxoid; distributed by GuangZhou LOSO Science Ltd), and all isolates with penicillin MICs  $\geq 2.0$  mg/L were tested for  $\beta$ -lactamase production because some strains with penicillin MIC of  $\geq 2.0$  mg/L can produce  $\beta$ -lactamase. Plasmid-mediated tetracycline resistant *N. gonorrhoeae* (TRNG) was defined as an isolate having a tetracycline MIC of  $\geq 16.0$  mg/L.

### 2.3.3 Interpretation Criteria for Resistance Phenotypes

Interpretative criteria for MIC classification were those described by the CLSI (CLSI 2006, 2009). MICs are classified into susceptible (S), intermediate (I) and resistant (R) for each antimicrobial (**Table 2.1**).

An isolate can exhibit resistance to single or multiple antibiotics, mediated chromosomally or by carrying resistance plasmids, or both. The resistance phenotypes classified in this study included: PPNG ( $\beta$ -lactamase positive), TRNG (TET MIC  $\geq 16$  mg/L and  $\beta$ -lactamase negative), PP/TRNG ( $\beta$ -lactamase positive and TET MIC  $\geq 16$  mg/L), PEN<sup>R</sup> (PEN MIC  $\geq 2.0$  mg/L), TET<sup>R</sup> (TET MIC  $\geq 2.0$  mg/L), CIP<sup>R</sup> (CIP MIC  $\geq 1.0$  mg/L), SPT<sup>R</sup> (SPT MIC  $\geq 128.0$  mg/L), CMPR (non-PPNG, TET MIC  $< 2.0$  mg/L and PEN MIC  $\geq 2.0$  mg/L), CMTR (non-PPNG, non-TRNG,

PEN MIC < 2.0 mg/L and TET MIC  $\geq$  2.0 mg/L), and CMRNG (non-PPNG, non-TRNG, PEN MIC  $\geq$  2.0 mg/L and TET MIC  $\geq$  2.0 mg/L). An isolate can exhibit more than one resistance phenotype. For example, the phenotype of CMTR/CIP<sup>R</sup>/PPNG indicates a combination of chromosomally mediated resistances to TET, CIP resistance, and that it is  $\beta$ -lactamase positivity.

For ceftriaxone, the susceptible (S) breakpoint is defined as having MICs  $\leq$  0.25 mg/L (CLSI 2006, 2009). Breakpoints for intermediate-levels of susceptibility (I) and resistance (R) have not been defined. The CLSI defines reduced susceptibility to ceftriaxone as having MICs > 0.25 mg/L, whereas the European Committee on Antimicrobial Susceptibility Testing (EUCAST) defines reduced susceptibility to ceftriaxone (CRO) as having MICs > 0.125 mg/L (Cole et al 2010). In previous studies in *N. gonorrhoeae* clinical isolates, a variety of definitions for reduced (decreased) susceptibility to ceftriaxone have been used [e.g. 0.016-0.06 mg/L (Whiley et al 2010);  $\geq$  0.12 mg/L (Lee et al 2010); 0.016-0.25 mg/L (Whiley et al 2007a/b);  $\geq$  0.125 mg/L (Ito et al 2005); and 0.064-0.125 mg/L (Lindberg et al 2007)]. Therefore, in this study I defined reduced susceptibility to ceftriaxone as having CRO MICs = 0.125-0.25mg/L.

#### **2.4 Chromosomal DNA Isolation from *N. gonorrhoeae* Isolates**

Chromosomal DNA from *N. gonorrhoeae* isolates was prepared at the Laboratory Diagnostic Centre of the SSDSH and shipped to the University of Saskatchewan, Canada for analysis. Chromosomal DNA of *N. gonorrhoeae* FA1090 was prepared at U of Saskatchewan for use as positive controls in PCR reactions.

The Promega Wizard® Genomic DNA Purification Kit was used for isolating gonococcal genomic DNA (Promega USA, distributed by the Shanghai Promega Biological Products Ltd, Shanghai, China). Briefly, *N. gonorrhoeae* cells were grown overnight on GCBI plates. Bacterial suspensions were prepared from overnight culture in 0.9% saline to a turbidity equivalent to that of a 0.5 McFarland standard (Remel, Lenexa KS, USA,  $\sim 10^8$  cfu/mL). One milliliter of the cell suspension was used for chromosomal DNA extraction. Cells were pelleted by centrifugation at 13,000–16,000  $\times g$  for 2 minutes. Cells were gently re-suspended in lysis solution (600  $\mu$ L) and incubated at 80°C for 5 minutes to lyse the cells. After cooling to room temperature, RNase

solution (3 µL) was added to the cell lysate and incubated at 37°C for 15–60 minutes. The RNase-treated cell lysates were vigorously mixed with Protein Precipitation Solution and incubated on ice for 5 minutes. Proteins and debris were removed by centrifugation. DNA in the supernatant was precipitated by isopropanol (600 µL). Following centrifugation, DNA pellets were washed with 70% ethanol (600 µL), and DNA was rehydrated in ddH<sub>2</sub>O (100 µL). The rehydrated DNA samples were shipped at room temperature.

## 2.5 Polymerase Chain Reactions and DNA Sequencing Analysis

Targeted genes/loci were amplified from chromosomal DNA of *N. gonorrhoeae* isolates by polymerase chain reactions (PCR). Targeted genes/loci in this study included *porB*, *tbpB*, *gyrA*, *parC*, *mtrR*, *penA* and *ponA* (Figs. 1.5, 1.12 & 1.14). The amplicons were subjected to DNA sequencing analysis.

### 2.5.1 Primers

Primers used for PCR and DNA sequencing reactions are listed in **Table 2.2**. Primers were purchased from Invitrogen Canada (Burlington, ON). Primer stock solutions were prepared by dissolving individual primers in TE at a concentration of 100 µM. Primer stocks were stored at -20°C. Primer pair *porB*-F/*porB*-R was used to amplify the entire *porB* gene and to sequence the extended-length of *porB* sequence (Unemo et al 2003). The DNA sequences of an internal segment of the *porB* gene are also used for *N. gonorrhoeae* Multi-Antigen Sequence Typing (NG-MAST) (Martin et al 2004). Primer pair *tbpB*-F/*tbpB*-R was used to amplify *tbpB* locus and to sequence the internal segment of *tbpB* for NG-MAST analysis.

Primer pairs *gyrA*-F/*gyrA*-R and *parC*-F/*parC*-R were used to amplify and sequence the quinolone resistance determinant regions (QRDRs) in *gyrA* and *parC*, respectively (Belland et al 1995, Trees et al 1999). Primer pair *mtrR*-F/*mtrR*-R was used to amplify *MtrR* coding sequences and the *mtrR* promoter regions (Hagman & Shafer 1995; Lucas et al 1997). Primer pair *penA*-F/*penA*-R was used to amplify and sequence the coding sequences of the polymorphic regions of the penicillin binding protein 2 (PBP2) (Ochiai et al 2007; Ito et al 2005). Primer pair *ponA*-F/*ponA*-R was used to amplify and sequence partial *ponA* gene (Ropp et al 1997, 2002).

**Table 2.2 Primers used for PCR and DNA Sequencing Reactions**

Primer Name	Sequence (5' to 3')	Locus and GenBank accession number of the locus	Sequenced regions	References
porB-F	CCGGCCTGCTTAAATTTCTTA	porB, J03017	nt <sup>*</sup> 72-933, coding for AA25-311 <sup>§</sup>	Unemo et al 2003, Martin et al 2004
porB-R	TATTAGAATTTGTGGCGCAG			
tbpB-F	CGTTGTCCGGCAGCGCGAAAAC	tbpB, 2286066	nt 1098-1686	Martin et al 2004
tbpB-R	TTCATCGGTGCGCTCGCCTTG			
gyrA-F	ACTGTACGCGATGCACGAGC	gyrA, U08817	nt 195-432, coding for AA66-144	Belland et al 1994
gyrA-R	TCTGCCAGCATTTCATGTGAG			
parC-F	GTTTCAGACGGCCAAAAGCC	parC, U08907	nt 120-399, coding AA41-133	Belland et al 1994
parC-R	GGCATAAAAATCCACCGTCCCC			
mtrR-F	AACAGGCATTCTTATTTTCAG	mtrR, Z25796	nt -1 – 120 (promoter), nt 1-630 coding sequences of full-length MtrR (AA 1-210)	Hagman & Shafer 1995, Lucas et al 1997
mtrR-R	TTAGAAGAATGCTTTGTGTC			
penA-F	CGATATGATCGAACCTGG	penA, X07468	nt 1017-1725, coding AA340-575	Ito et al 2005, Whiley et al 2007a
penA-R	ACAATCTCGTTGATACTCG			
ponA-F	CGCGGTGCGGAAAACACTATATCGAT	ponA, U72876	nt 987-1950, coding for AA330-650	Ropp et al 1997, 2002
ponA-R	AGCCCGGATCGGTTACCATACGTT			
JDA-F	TACTCAATCGGTAATTGGCTTC		PCR amplification of $\beta$ -lactamase producing plasmids	Dillon et al 1999
JDB-R	CCATATCACCGTCGGTACTG			
RM4-F	CCAAATCCTTTCTGGGCT		PCR amplification of <i>tetM</i>	Xia et al 1995
G1-R	ATCACTCACAGTTAAT			

\*: nt- nucleotide positions. §: AA- amino acid

### 2.5.2 Polymerase Chain Reactions

The PCR mixture (50  $\mu$ L) contained 2-5  $\mu$ L of genomic DNA, 2.5 U of Taq DNA polymerase (Amersham Bioscience), 1 x PCR buffer with 1.5 mM MgCl<sub>2</sub>, 0.25 mM dNTPs, and 0.5  $\mu$ M of each primer. Amplification (Perkin Elmer 9600 Thermo Cycler, Wellesley, MA, USA) was performed as follows: an initial denaturing step at 94<sup>0</sup>C for 4 min, followed by 30 sequential cycles of 94<sup>0</sup>C for 1 min, 55<sup>0</sup>C for 45 s, 72<sup>0</sup>C for 45 s (for *tbpB*, *gyrA* and *parC*) or 1 min (for *porB*, *mtrR*, *penA* and *ponA*), and a final extension phase at 72<sup>0</sup>C for 10 min. PCR products were purified using the Qiagen PCR Purification Kit according to the manufacturer's instructions (Qiagen, Mississauga, Ontario, Canada). DNA was eluted from the column in 50  $\mu$ L ddH<sub>2</sub>O. DNA samples of the PCR products were analyzed by agarose gel electrophoresis (Shambrook & Russel 2001) and examined for purity and size as compared to DNA standards (1kb Plus DNA ladders, New England Biorad). DNA solutions were stored at -20<sup>0</sup>C for use in subsequent DNA sequencing analysis.

### 2.5.3 DNA Sequencing

DNA sequences of both strands for each locus amplified were determined using an Applied Biosystems 3730x1 DNA Analyzer (Plant Biotechnology Institute, National Research Council of Canada, Saskatoon, SK). Primers used for DNA sequencing reactions of the targeted loci were the same as the primers used in PCR reactions (**Table 2.2**). Primers were freshly prepared from stock solutions by diluting them in ddH<sub>2</sub>O to a final concentration of 4  $\mu$ M. PCR product was also diluted in ddH<sub>2</sub>O to a final concentration of 10 ng/ $\mu$ L for amplicons with a length of less than 500 base pairs (bp) and to a concentration of 100 ng/ $\mu$ L for amplicons with a length of  $\geq$  500 bp. Using the above-mentioned PCR conditions, purified PCR products were diluted 1:4 for amplicons of the *gyrA*, *parC* and *tbpB* genes, and 1:2 for amplicons of the *porB*, *mtrR*, *penA* and *ponA* genes.

### 2.5.4 DNA Sequence Verification and Editing

DNA sequences were verified and edited using online programs and occasionally by manual examination (Unemo et al 2002). Chromas Lite (<http://www.softpedia.com/get/Science-CAD/Chromas-Lite.shtml>) was used to view and edit chromatograms. The Clustal W program (<http://www.ebi.ac.uk/Tools/clustalw2/index.html>) was used to align DNA sequences of both

complementary strands (Larkin et al 2007). Aligned DNA sequences were viewed and edited using the Jalview program (Clamp et al 2004). A reference sequence for each locus was used for trimming DNA sequences (**Table 2.3**). Flanking sequences corresponding to the reference sequence were removed or trimmed. After removing gaps introduced during the alignment, DNA sequences were output in a FASTA format. DNA sequences were copied and pasted in Notepad, creating DNA sequence databases for subsequent analysis.

**Table 2.3 Reference DNA Sequences Used in This Study**

Locus	Nucleotide (nt) position	GenBank accession number
porB (Extended-length)	nt 72-933, gaps included	J03017
porB (for NG-MAST)	Start at nt 350 extended for 490 bp exactly, gaps removed during alignment	M21289
tbpB	Start at nt 1098 extended for 390 bp exactly, gaps removed during alignment	2286066
gyrA	nt 220-360, QRDR coding sequences	U08817
parC	nt 210-390, QRDR coding sequences	U08907
mtrR ( <i>N. gonorrhoeae</i> FA1090)	nt -1 to -120 promoter sequences and sequences coding for full-length MtrR (nt 1-630)	YP_208426
penA	nt 1017-1725, coding for AA340-575 of PBP2 (full-length PBP2 581 AAs)	NC_002946
ponA	nt 1050-1890 coding AA350-630 of PBP1 (full-length PBP1 798 AAs)	U72876

NG-MAST: *Neisseria gonorrhoeae* multi-antigen sequence typing.

QRDR: Quinolone resistance determinant region.

nt: Nucleotides

AA: Amino acid.

PBP: Penicillin binding protein



## 2.6 Molecular Mechanisms of Antimicrobial Resistance in *Neisseria gonorrhoeae*

### 2.6.1 Plasmid Typing of $\beta$ -lactamase Producing and *tetM*-containing Plasmids

$\beta$ -lactamase-producing plasmids in *N. gonorrhoeae* were differentiated by PCR assays (Dillon et al 1999). PCR reactions were performed on extracted gonococcal DNA as templates using the primer pair JDA/JDB (**Table 2.2**). The amplified DNA products were analyzed by agarose gel electrophoresis followed by ethidium bromide staining and visualized under UV light (Shambrook & Russel 2001). PCR conditions were the same as described in Section 2.5.2, except for an extension time of 5 minutes in the reaction cycles (Dillon et al 1999). Controls included PCR on plasmid DNA pJD4, pJD5, and pJD7, which represent the Asia-, Africa- and Toronto-types of the  $\beta$ -lactamase-producing plasmids, respectively (Dillon et al 1999; Pagotto et al 2000). The sizes of PCR products of pJD4, pJD5, and pJD7 were 4.9 kilobases (kb), 3.1 kb, and 2.6 kb, respectively (Dillon et al 1999). Negative controls were comprised of distilled water and chromosomal DNA of *Escherichia coli* DH5a.

To determine the *tetM* plasmid types in *N. gonorrhoeae* isolates, the *tetM* locus was PCR-amplified from gonococcal DNA of isolates having a TET MIC  $\geq$  16.0 mg/L, using primer pairs RM4/G1 (**Table 2.2**; Xia et al 1995). PCR conditions were the same as described in Section 2.5.2, except for an extension time of 2 minutes in the reaction cycles (Xia et al 1995). PCR products were analyzed by agarose gel electrophoresis followed by ethidium bromide staining and visualized under UV light (Shambrook & Russel 2001). The America-type *tetM*-containing plasmid has an amplicon size of 1600 bp and the Dutch-type *tetM*-containing plasmid exhibits a fragment of 700 bp (Xia et al 1995).

### 2.6.2 Analysis of Antimicrobial Resistance Determinants in *N. gonorrhoeae* Isolates

In this study, targeted loci (*gyrA*, *parC*, *porB*, *mtrR*, *penA*, *ponA*), implicated in quinolone, penicillin, tetracycline and third-generation cephalosporin resistances and described in Chapter 1 (**Figs. 1.5** for PorB, **1.12** for PBPs and MtrR & **1.14** for GyrA and ParC) were analyzed. PCR reactions and DNA sequencing have been described in Sections 2.5.2 and 2.5.3, respectively.

Deduced amino acid sequences for each gene were obtained using the Proteomics and Sequence Tools (<http://ca.expasy.org/>, last accessed on December 21, 2009). To identify mutations, amino acid sequences were aligned with their respective prototypes for which GenBank accession numbers were shown in **Table 2.3**.

## 2.7 Phylogenetic Analysis of *N. gonorrhoeae* *porB*

The *porB* DNA sequences determined in this study comprised 7 polymorphic regions encoding the surface-exposed loops (Loops I - VII) and 6 conserved interspace regions (II - VII). This DNA fragment accounts for ~82% of the entire *porB* gene (Gotschlich et al 1987; Fudyk et al 1999; **Fig. 1.5**). The sequences of these regions were determined and used for analysis because they can be ascertained in a single DNA sequencing reaction of one strand of the amplicon, and because the discriminatory power is high enough for molecular epidemiological studies (van Looveren et al 1999; Dillon et al 1993; Hunter & Gaston 1988).

*porB* genotypes were assigned as *porB1a* or *porB1b* based on the presence or absence of two nucleotide sequences in the loop V coding region, as described previously (van der Ley et al 1991; Gotschlich et al 1987; Danielsson et al 1986; Olesky et al 2002); *porB1a* was characterized by the absence of ~50 nucleotides (nt) corresponding to the positions nt681-705 and nt718-736 of *porB1b*. *porB* DNA sequences of two widely used *N. gonorrhoeae* strains were used as templates for *porB1a* and *porB1b* assignment. *N. gonorrhoeae* MS11 possesses *porB1a* (GenBank #J03029), and *N. gonorrhoeae* FA1090 has *porB1b* (GenBank #J03017).

Edited DNA sequences were separated into 2 data sets, i.e. *porB1a* and *porB1b*. DNA sequences in FASTA format were converted into a NEXUS format using the Clustal X program (<http://bips.u-strasbg.fr/fr/Documentation/ClustalX>; Thompson et al 1997) for subsequent use in the PAUP program.

Phylogenetic analyses were conducted with PAUP version 4.0b10, according to the publisher's instructions (Swofford 2002). Alignments were not stripped of gaps before phylogenetic analysis (Unemo et al 2002, 2003). Maximum parsimony (MP) trees were generated

with 1000 heuristic searches. Parsimony-informative characters in random stepwise addition and tree bisection and reconstruction (TBR) were used as branch swapping algorithm. MAXTREES were set to 5000, branches of zero length were collapsed, and all most parsimonious trees were saved. Branch support for all parsimony analyses was estimated by performing 1000 bootstrap replicates (Felsenstein 1985) with a heuristic search consisting of 10 random-addition replicates for each bootstrap replicate. Trees were figured and viewed in Treeview (Page 1996; <http://taxonomy.zoology.gla.ac.uk/rod/treeview.html>). Some of the *porB1b* data sets were divided into subclasses based on phylogenetic trees generated using Clustal W. This division facilitated subsequent PAUP analysis because the PAUP program is only able to manipulate datasets of ~60-100 variable DNA sequences (Swofford 2002).

### **2.8 *Neisseria gonorrhoeae* Multi-Antigen Sequence Typing (NG-MAST)**

The NG-MAST database and programs for assigning sequence types (ST) of *N. gonorrhoeae* isolates are available online ([www.ng-mast.net](http://www.ng-mast.net), Martin et al 2004).

Briefly, *tbpB* and *porB* loci were amplified by PCR methods and amplicons were sequenced using the primer pairs of *tbpB*-F/*tbpB*-R and *porB*-F/*porB*-R (**Table 2.2**) as described in Section 2.5. *porB* and *tbpB* DNA sequences were trimmed using the template sequences specified in the NG-MAST database ([www.ng-mast.net](http://www.ng-mast.net)). The template DNA sequence for *porB* or *tbpB* comprises 490 bp (*porB*) and 390 bp (*tbpB*). DNA sequences were input into the sequence input windows in the NG-MAST website. An allele type was assigned to either *porB* or *tbpB* of each isolate, and a sequence type (ST) was assigned to the isolate based on *porB* and *tbpB* types. The allele types and STs were deposited in the NG-MAST database. Allele types or STs which are novel to the database were indicated. Therefore, previously identified alleles of *porB* and *tbpB*, and STs were obtained by interrogating the NG-MAST website. Previously unrecognized NG-MAST STs were submitted to the website in order to obtain an identity for new alleles and novel STs.

## 2.9 Concordance between Sexual Networks Established from Epidemiological Information and Revealed by DNA Sequence Types of *porB*

Since molecular typing can complement contact tracing for reconstructing gonorrhoea sexual networks, the concordance between *porB* genotypes of dyads or triads of *N. gonorrhoeae* isolates from recent sexual contacts was examined. Components of sexual networks (dyads or triads) were constructed using the index-named contact data, and the recorded dates at which specimens were obtained from named sexual contacts (Bilek et al 2007). These epidemiological contacts were compared to the assigned STs in NG-MAST analysis to obtain congruent percentages between the results of the two study methods. To determine the congruence of *porB* sequence types and epidemiological linkages, a neighbor-joining tree of *porB* sequences from sexual relationships was constructed using the Clustal W program (Larkin et al 2007).

## 2.10 Statistical Analysis

Yates' Chi-square tests were performed on differences of percentage distribution (Ury & Fleiss 1980; Yates 1934). Significance was set at a P value of < 0.05. The Yates' correction prevents overestimation of statistical significance for small data sets. This reduces the chi-square value obtained and thus increases its p-value.

Correlation coefficients (R) between QRDR mutation rates (Y) and ciprofloxacin MICs (X) were determined using the formula:

$$R = \frac{N(\sum XY) - (\sum X)(\sum Y)}{\sqrt{[N\sum X^2 - (\sum X)^2][N\sum Y^2 - (\sum Y)^2]}}$$

N is the total number of isolates. The "R" values represent the strength of association between two variables, X and Y. The R values were calculated using Excel Statistical Tools or an online program (<http://easycalculation.com/statistics/correlation.php>).

Simpson's index of diversity (ID) was used to determine the discriminatory abilities of the molecular typing methods (Dillon et al 1993; Hunter & Gaston 1988). The numerical index is based on the probability that two unrelated isolates would be placed into different typing groups (Hunter & Gaston 1988). The calculation formula is:

$$ID = 1 - [1/N(N-1)] [\sum n_i(n_i-1)]$$

N equals the sum of all of the isolates, and  $n_i$  is the size of the  $i^{\text{th}}$  group. ID is expressed as a percentage. An ID of 90% or greater is desirable for a typing scheme (Hunter & Gaston 1988), depending on the objectives of molecular epidemiological studies.

## 2.11 DNA Sequence Deposit

DNA sequences were submitted to the National Center for Biotechnology Information (NCBI) GenBank (<http://www.ncbi.nlm.nih.gov/WebSub/?tool=genbank>). GenBank accession numbers were reported for *porB* (EF540591 - EF540669, EU719202 - EU719208, HM481249 - HM481254 and HM490092 - 490124), *gyrA* (HM563745 - HM563747), *parC* (HM579826 - HM579837), *mtrR* (HM467704 - HM467711), *penA* (HM490125 - HM490141), and *ponA* (HM467700 - HM467704). The DNA sequences of *porB* and *tbpB* for NG-MAST analysis were stored in the NG-MAST database (<http://www.ng-mast.net>; Martin et al 2004).

## **CHAPTER THREE**

### **RESULTS**

At the Shanghai Skin Disease and STD Hospital, 5036 clinic patients were tested for gonorrhea infections in 2005. Among them, 1627 cases were *N. gonorrhoeae* culture positive (Gu and Liao, unpublished data). In our research, 402 male gonorrhea patients were asked to participate in the study in 2005, of whom 40 (10%) withdrew due to time constraints of the patients. In total 342 male gonorrhea patients were successfully interviewed as index patients who described 526 sexual partners. Subsequently, 106 sexual partners of the index cases were recruited and interviewed in our research. At the time I ended field work in this PhD project in the middle of 2008, the recruitment of participants were ongoing, and I used cases consecutively enrolled in the early 2008.

*N. gonorrhoeae* isolates I studied were consecutively collected from gonorrhea patients in 2005 and 2008 in Shanghai; among those isolates collected, there were 74 sexual links (74 isolates from male index cases, 78 from female partners, forming 70 dyads and 4 triads). *N. gonorrhoeae* isolates were also obtained from the isolate collection in the Urumchi STD Center in 2007-2008.

### **3.1 Antimicrobial Resistance in *Neisseria gonorrhoeae***

Antimicrobial susceptibility of *N. gonorrhoeae* isolates consecutively collected from Shanghai (SH2005 and SH2008) and Urumchi (UQ2008) was tested against 5 antimicrobial agents [penicillin (PEN), tetracycline (TET), ciprofloxacin (CIP), ceftriaxone (CRO), and spectinomycin (SPT)]. To minimize clonal effects, only results of isolates collected from individual male patients were analyzed.

#### **3.1.1 Antimicrobial Resistance of 159 *N. gonorrhoeae* Isolates from Shanghai in 2005**

Part of these results was reported in J Antimicrob Chemother (Yang et al 2006). Permission to use has been obtained from the Oxford University Press License (**Appendix A2.3**).

The antimicrobial susceptibilities of 159 *N. gonorrhoeae* isolates (SH2005) from male patients in Shanghai in 2005 (SH2005) are summarized in **Table 3.1**.

Penicillin (PEN) MICs ranged from 0.5 -  $\geq 64$  mg/L, with an MIC<sub>50</sub> of 32 mg/L and an MIC<sub>90</sub>  $\geq 64$  mg/L; 93.1% of the isolates were resistant to PEN and 6.9% demonstrated intermediate levels of susceptibility (MICs=0.5-1.0 mg/L). Plasmid mediated PEN resistance was observed in 51.6% of the isolates with 37.8% (n=60) being PPNG and 13.8% (n=22) being PP/TRNG. Chromosomal PEN resistance was observed in 41.5% of the isolates with 23.3% (n=37) classified as CMPR and 18.2% (n=29) as CMRNG.

The total burden of tetracycline (TET) resistance was 56.5% and included isolates classified as TRNG (6.3%), PP/TRNG (13.8%), CMTR (18.2%), and CMRNG (18.2%). Isolates had TET MICs extending from 0.06 to  $\geq 64.0$  mg/L with an MIC<sub>50</sub> of 2 mg/L and an MIC<sub>90</sub> of 32 mg/L.

The ciprofloxacin (CIP) MIC range of the isolates was 0.06- $\geq 64$  mg/L (MIC<sub>50</sub> and MIC<sub>90</sub> values of 8 and 32 mg/L, respectively); 98.7% of the isolates were Cip<sup>R</sup> while 1 (0.6%) isolate was susceptible, and 1 (0.6%) was classified at an intermediate (MIC=0.5 mg/L) susceptibility level.



**Table 3.1 MICs of 159 *N. gonorrhoeae* isolates from Shanghai 2005 to 5 antimicrobial agents<sup>§</sup>**

Antibiotic <sup>a</sup>	MICs (mg/L)																MIC <sub>50</sub>	MIC <sub>90</sub>	
	0.002	0.004	0.008	0.015	0.03	0.06	0.125	0.25	0.5	1.0	2.0	4.0	8.0	16.0	32.0	≥64.0 <sup>b</sup>			
PEN																			
N							<b>0</b>	<b>0</b>	<b>3</b>	<b>8</b>	19	26	16 <sup>d</sup>	5	3 <sup>d</sup>	79 <sup>d</sup>			
Cum %							<b>0.0<sup>c</sup></b>	<b>0.0</b>	<b>1.9</b>	<b>6.9</b>	18.8	35.2	45.3	48.4	50.3	100.0		32.0	≥64.0
TET																			
N						<b>2</b>	<b>9</b>	<b>16</b>	<b>15</b>	<b>27</b>	34	17	7	11	12	9			
Cum %						<b>1.3</b>	<b>6.9</b>	<b>17.0</b>	<b>26.4</b>	<b>43.4</b>	64.8	75.5	79.9	86.8	94.3	100.0		2.0	32.0
CIP																			
N	<b>0</b>	<b>0</b>	<b>0</b>	<b>0</b>	<b>0</b>	<b>1</b>	<b>0</b>	<b>0</b>	<b>1</b>	6	27	35	47	23	16	3			
Cum %	<b>0.0</b>	<b>0.0</b>	<b>0.0</b>	<b>0.0</b>	<b>0.0</b>	<b>0.6</b>	<b>0.6</b>	<b>0.6</b>	<b>1.3</b>	5.1	22.1	44.1	73.6	88.1	98.1	100.0		8.0	32.0
SPT																			
N											<b>0</b>	<b>8</b>	<b>16</b>	<b>72</b>	<b>60</b>	<b>3</b>			
Cum %											<b>0.0</b>	<b>5.0</b>	<b>15.1</b>	<b>60.4</b>	<b>98.1</b>	<b>100.0</b>		16.0	32.0
CRO																			
N	<b>0</b>	<b>3</b>	<b>10</b>	<b>22</b>	<b>57</b>	<b>48</b>	18	1											
Cum %	<b>0.0</b>	<b>1.9</b>	<b>6.38</b>	<b>22.0</b>	<b>57.9</b>	<b>88.1</b>	99.4	100.0										0.03	0.125

18

§: This result has been published in J Antimicrob Chemother (Yang et al 2006). Permission to use has been obtained from the Oxford University Press.

a. N: Number of isolates; Cum %: Cumulative percent. PEN-penicillin, TET-tetracycline, CIP-ciprofloxacin, SPT-spectinomycin, CRO-ceftriaxone.

b. End of concentration range for PEN, TET and CIP MIC testing.

c. Bold indicates isolates with MICs below breakpoint or available limits of susceptibility. Breakpoints have not been determined for CRO and MICs > 0.125 mg/L are considered having reduced susceptibility in this study.

d. PPNG isolates. PEN MICs = 8 mg/L (1 isolate), 32 mg/L (2 isolates) and ≥ 64 mg/L (79 isolates).

All isolates were susceptible to spectinomycin (SPT; MIC <128.0 mg/L) with 98.1% having MICs classified as susceptible and 1.9% (n=3) demonstrating intermediate (MIC=64.0 mg/L) levels of susceptibility. All isolates were susceptible to ceftriaxone (CRO; MICs=0.004-0.25 mg/L; MIC<sub>50</sub> and MIC<sub>90</sub>: 0.03 and 0.125 mg/L, respectively). Noticeably 11.9% (n=19) of the isolates exhibited reduced susceptibility to CRO, with an MIC of 0.125 mg/L (n=18) or 0.25 mg/L (n=1), respectively.

Isolates with multiple drug resistant (MDR) phenotypes were PPNG-CIP<sup>R</sup> (20.8%), CMPR-CIP<sup>R</sup> (16.4%), CMRNG-CIP<sup>R</sup> (18.2%), PPNG-CMTR-CIP<sup>R</sup> (17.6%), and PP/TRNG-CIP<sup>R</sup> (13.2%).

### **3.1.2 Antimicrobial Resistance of 71 *N. gonorrhoeae* Isolates from Shanghai in 2008**

The antimicrobial susceptibility of *N. gonorrhoeae* isolates (SH2008) to PEN, TET, CIP, SPT, and CRO is summarized in **Table 3.2**.

The percentages of *N. gonorrhoeae* isolates resistant to CIP, PEN or TET were 100%, 88.7%, and 64.8%, respectively. Isolates with chromosomal resistance to PEN (CMPR), TET (CMTR), or both antibiotics (CMRNG) accounted for 32.4%, 8.5% and 5.6%, respectively. Seventy-nine percent of isolates carried plasmid-mediated resistance (PPNG - 22.5%, TRNG - 22.5%, PP/TRNG - 33.8%).

All isolates were susceptible to SPT, and SPT MIC<sub>50</sub> and MIC<sub>90</sub> were 32 and 64 mg/L, respectively. Seven isolates (9.9%) displayed an intermediate level of susceptibility to SPT (MIC=64.0 mg/L). All isolates were susceptible to CRO (MIC<sub>50</sub> and MIC<sub>90</sub>: 0.06 and 0.125 mg/L, respectively). Notably, 19.7% (n=14) isolates exhibited reduced susceptibility to CRO (MIC=0.125 mg/L).

Isolates having MDR phenotypes comprised PPNG-CIP<sup>R</sup> (22.5%), TRNG-CIP<sup>R</sup> (22.5%), PP/TRNG-CIP<sup>R</sup> (33.8%), CMPR-CIP<sup>R</sup> (32.4%), CMRNG-CIP<sup>R</sup> (5.6%), and CMTR-CIP<sup>R</sup> (8.5%).

**Table 3.2 MICs of 71 *N. gonorrhoeae* isolates from Shanghai in 2008 to 5 antimicrobial agents**

Antibiotic <sup>a</sup>	MICs (mg/L)																MIC <sub>50</sub>	MIC <sub>90</sub>	
	0.002	0.004	0.008	0.015	0.03	0.06	0.125	0.25	0.5	1.0	2.0	4.0	8.0	16.0	32.0	≥64.0 <sup>b</sup>			
PEN																			
N																	32.0	≥64.0	
Cum %																			
						<b>0</b>	<b>0</b>	<b>1</b>	<b>7</b>	13	9	2 <sup>d</sup>	0	6 <sup>d</sup>	33 <sup>d</sup>				
						<b>0.0<sup>c</sup></b>	<b>0.0</b>	<b>1.4</b>	<b>11.3</b>	29.6	42.3	45.0	45.0	53.5	100.0				
TET																			
N																	16.0	64.0	
Cum %																			
					<b>0</b>	<b>1</b>	<b>2</b>	<b>6</b>	<b>16</b>	6	0	0	4	12	24				
					<b>0.0</b>	<b>1.4</b>	<b>4.2</b>	<b>12.7</b>	<b>35.2</b>	43.7	43.7	43.7	49.3	66.2	100.0				
CIP																			
N	<b>0</b>	<b>0</b>	<b>0</b>	<b>0</b>	<b>0</b>	<b>0</b>	<b>0</b>	<b>0</b>	<b>0</b>	2	2	14	25	25	3	0	8.0	16.0	
Cum %	<b>0.0</b>	<b>0.0</b>	<b>0.0</b>	<b>0.0</b>	<b>0.0</b>	<b>0.0</b>	<b>0.0</b>	<b>0.0</b>	<b>0.0</b>	2.8	5.6	25.4	60.6	95.8	100	100.0			
SPT																			
N																	32.0	32.0	
Cum %																			
										<b>0</b>	<b>1</b>	<b>2</b>	<b>19</b>	<b>42</b>	<b>7</b>				
										<b>0.0</b>	<b>1.4</b>	<b>4.2</b>	<b>31.0</b>	<b>90.1</b>	<b>100.0</b>				
CRO																			
N	<b>0</b>	<b>0</b>	<b>2</b>	<b>4</b>	<b>26</b>	<b>25</b>	14	0										0.06	0.125
Cum %	<b>0.0</b>	<b>0.0</b>	<b>2.8</b>	<b>8.5</b>	<b>45.1</b>	<b>80.3</b>	100.0	100.0											

a. N: Number of isolates; Cum %: Cumulative percent. PEN-penicillin, TET-tetracycline, CIP-ciprofloxacin, SPT-spectinomycin, CRO-ceftriaxone.

b. End of concentration range for PEN, TET and CIP MIC testing. End concentration for SPT was 128 mg/L, no isolates have a SPT MIC of 128 mg/L.

c. Bold indicates isolates with MICs below breakpoint or available limits of susceptibility. Breakpoints have not been determined for CRO and MICs > 0.125 mg/L are considered having reduced susceptibility in this study.

d. PPNG isolates. PEN MICs = 8 mg/L (1 isolate), 32 mg/L (4 isolates) and ≥ 64 mg/L (33 isolates).

### 3.1.3 Antimicrobial Resistance of 44 *N. gonorrhoeae* Isolates from Urumchi

The antimicrobial susceptibility of 44 *N. gonorrhoeae* isolates (UQ2008) to PEN, TET, CIP, SPT, and CRO is summarized in **Table 3.3**.

The percentages of isolates resistant to CIP, PEN, or TET were 97.7%, 79.5%, and 61.4%, respectively. Isolates with chromosomal resistance to PEN (CMPR), TET (CMTR), or both antibiotics (CMRNG) accounted for 34.1%, 25.0%, and 11.9%, respectively. Sixty-three percent of isolates exhibited plasmid-mediated resistant phenotypes (PPNG – 15.9%, TRNG – 18.2%, PP/TRNG – 28.6%).

All isolates were susceptible to SPT ( $MIC \leq 32.0$  mg/L), and SPT  $MIC_{50}$  and  $MIC_{90}$  were 32.0 mg/L, respectively. No isolates had intermediate levels of susceptibility to SPT. All isolates were susceptible to CRO ( $MIC_{50}$  and  $MIC_{90}$ : 0.03 and 0.06 mg/L, respectively). A small percentage of isolates (4.5%, n=2) had reduced susceptibility to CRO ( $MIC=0.125$  mg/L).

Isolates having MDR phenotypes were (PPNG-CIP<sup>R</sup> (13.6%), TRNG-CIP<sup>R</sup> (18.2%), PP/TRNG-CIP<sup>R</sup> (28.6%), CMPR-CIP<sup>R</sup> (34.1%), CMTR-CIP<sup>R</sup> (25.0%), and CMRNG-CIP<sup>R</sup> (11.9%).

**Table 3.3 MICs of 44 *N. gonorrhoeae* isolates from Urumchi 2008 to 5 antimicrobial agents**

Antibiotic <sup>a</sup>	MICs (mg/L)																MIC <sub>50</sub>	MIC <sub>90</sub>		
	0.002	0.004	0.008	0.015	0.03	0.06	0.125	0.25	0.5	1.0	2.0	4.0	8.0	16.0	32.0	≥64.0 <sup>b</sup>				
PEN																				
N							<b>0</b>	<b>2</b>	<b>1</b>	<b>6</b>	8	7	0	1 <sup>d</sup>	0	19 <sup>d</sup>				
Cum %							<b>0.0<sup>c</sup></b>	<b>4.5</b>	<b>6.8</b>	<b>20.5</b>	38.6	54.5	54.5	63.6	63.6	100.0			4.0	≥64.0
TET																				
N						<b>0</b>	<b>0</b>	<b>7</b>	<b>7</b>	<b>3</b>	5	0	2	3	1	16			2.0	64.0
Cum %						<b>0.0</b>	<b>0.0</b>	<b>15.9</b>	<b>31.8</b>	<b>38.6</b>	50.0	50.0	54.5	61.4	63.6	100.0				
CIP																				
N	<b>0</b>	<b>0</b>	<b>0</b>	<b>0</b>	<b>0</b>	<b>0</b>	<b>0</b>	<b>0</b>	<b>1</b>	0	4	9	17	11	2	0			8.0	16.0
Cum %	<b>0.0</b>	<b>0.0</b>	<b>0.0</b>	<b>0.0</b>	<b>0.0</b>	<b>0.0</b>	<b>0.0</b>	<b>0.0</b>	<b>2.3</b>	2.3	11.4	31.8	70.5	95.5	100.0	100.0				
SPT																				
N											<b>0</b>	<b>2</b>	<b>0</b>	<b>18</b>	<b>24</b>	<b>0</b>			32.0	32.0
Cum %											<b>0.0</b>	<b>4.5</b>	<b>4.5</b>	<b>45.5</b>	<b>100.0</b>	<b>100.0</b>				
CRO																				
N	<b>0</b>	<b>0</b>	<b>2</b>	<b>16</b>	<b>15</b>	<b>9</b>	2	0											0.03	0.06
Cum %	<b>0.0</b>	<b>0.0</b>	<b>4.5</b>	<b>40.9</b>	<b>75.0</b>	<b>95.5</b>	100.0	100.0												

85

a. N: Number of isolates; Cum %: Cumulative percent. PEN-penicillin, TET-tetracycline, CIP-ciprofloxacin, SPT-spectinomycin, CRO-ceftriaxone.

b. End of concentration range for PEN, TET and CIP MIC testing. End concentration for SPT was 128 mg/L, and no isolates have a SPT MICs of 128 mg/L.

c. Bold indicates isolates with MICs below breakpoint or available limits of susceptibility. Breakpoints have not been determined for CRO and MICs > 0.125 mg/L are considered having reduced susceptibility in this study.

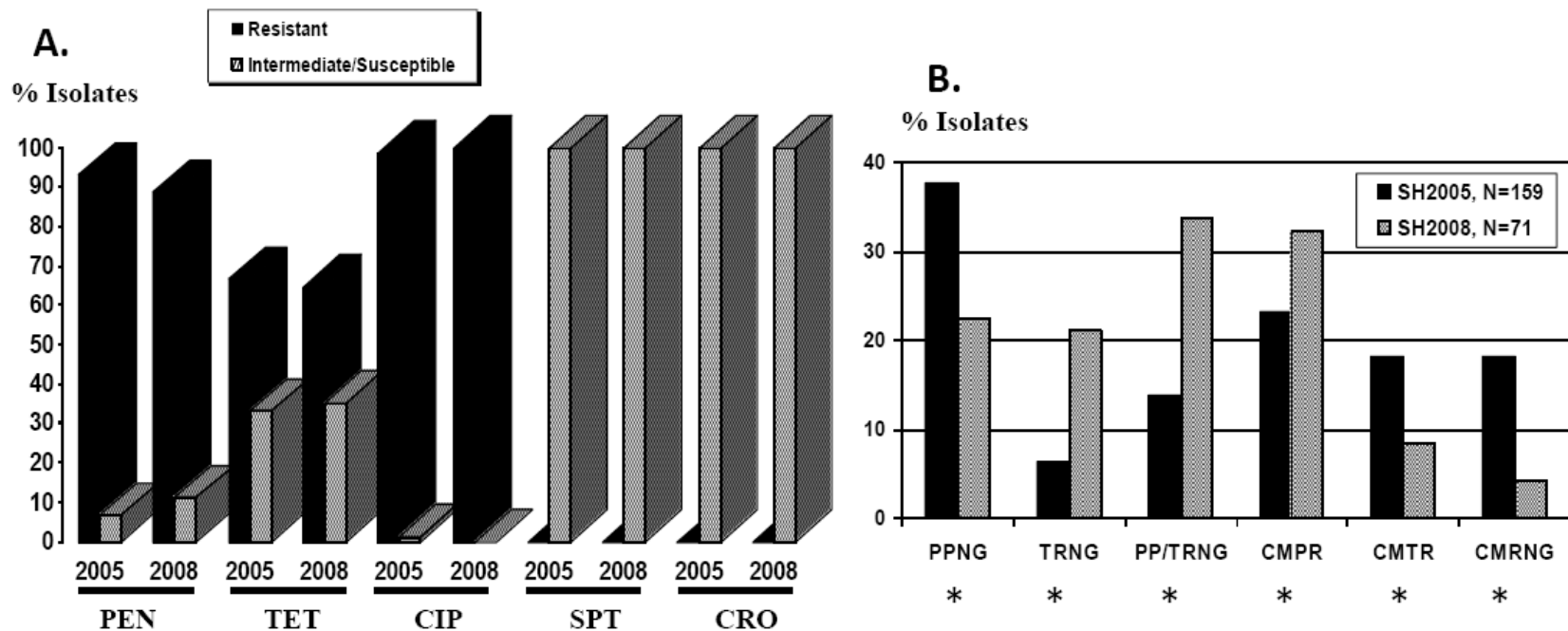
d. PPNG isolates. PEN MICs = 16 mg/L (1 isolate) and ≥ 64 mg/L (19 isolates).

### 3.1.4 Temporal Distribution of Antimicrobial Resistance of *N. gonorrhoeae* Isolates in Shanghai: 2005/2008

Percentages of *N. gonorrhoeae* isolates resistant to penicillin (PEN) were 93.1% (SH2005) and 88.7% (SH2008), to tetracycline (TET) 56.5% (SH2005) and 64.8% (SH2008), and to ciprofloxacin (CIP) 98.7% (SH2005) and 100% (SH2008). Resistance percentages (PEN, TET, and CIP) between SH2005 and SH2008 isolates were not significantly different ( $P>0.05$ ). Resistance to spectinomycin (SPT) and ceftriaxone (CRO) was not observed in either 2005 or 2008 ( $P>0.05$ , **Fig. 3.1A**).

Percentages of PPNG declined from 37.8% (SH2005) to 22.5% (SH2008), whereas TRNG % increased from 6.3% (SH2005) to 22.5% (SH2008). PP/TRNG increased from 13.8% (SH2005) to 33.8% (SH2008). CMPR % increased from 23.3% (SH2005) to 32.4% (SH2008). CMTR % declined from 18.2% (SH2005) to 8.5% (SH2008). CMRNG % decreased from 18.2% (2005) to 5.6% (2008). In all cases, these differences between 2005 and 2008 were significant ( $P<0.05$ , **Fig. 3.1B**).

MIC distributions of CIP, SPT, and CRO were compared (**Fig. 3.2**). A significantly higher percentage of isolates with CIP MICs  $\geq 8$  mg/L was observed in 2008 isolates (74.6%) as compared to 2005 (45.9%; **Fig. 3.2A**). A significantly higher percentage of the SH2008 isolates (68.9%) had SPT MICs of  $\geq 32$  mg/L as compared to the SH2005 isolates (39.6%; **Fig. 3.2B**). Isolates classified as having intermediate susceptibility to SPT (MIC=64 mg/L) rose to 9.9% in SH2008 as compared to 1.9% in SH2005 isolates. The distribution curve for CRO MICs shifted to the right for the SH2008 isolates as compared to that for the SH2005 isolates (**Fig. 3.2C**). Approximately 19.7% of the SH2008 isolates had CRO MICs of  $\geq 0.125$  mg/L, whereas 11.9% of the SH2005 isolates had CRO MICs of  $\geq 0.125$  mg/L.

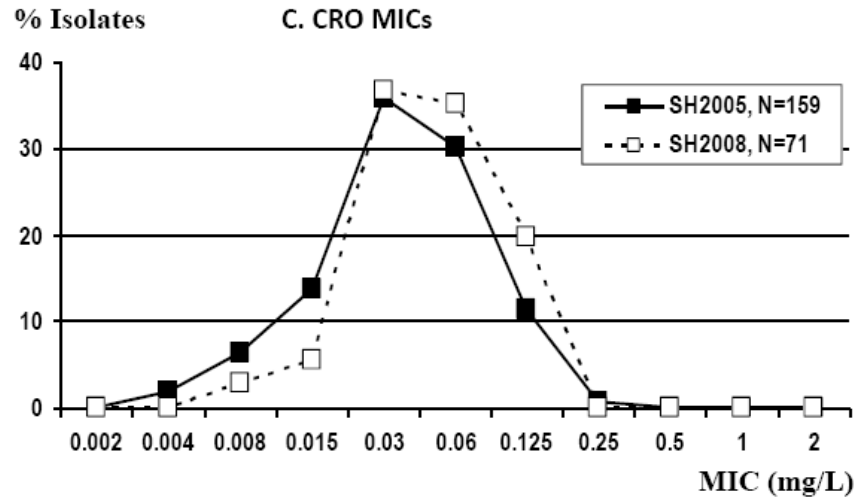
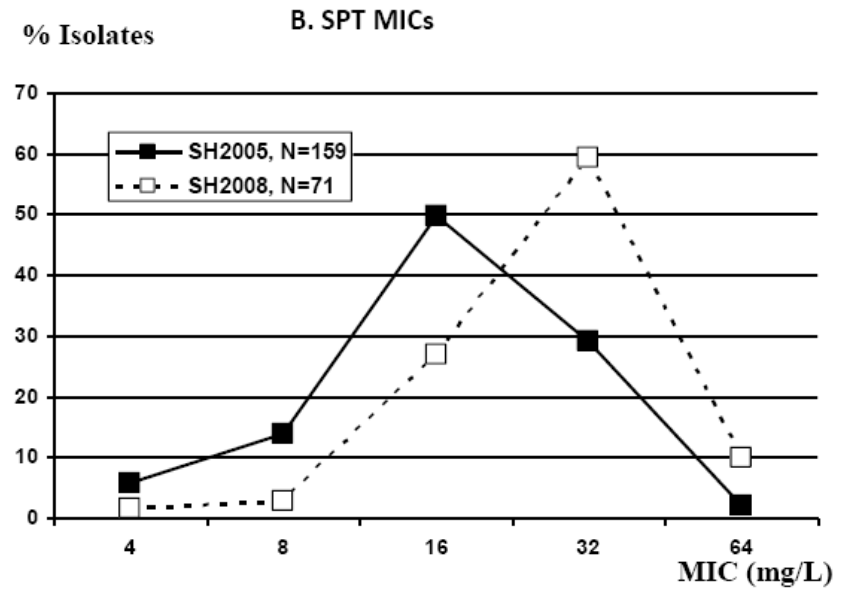
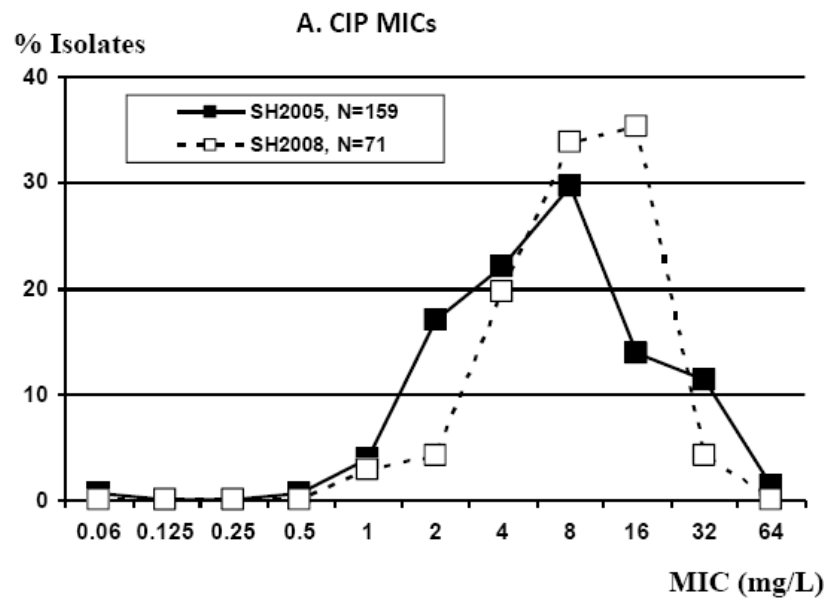


**Fig. 3.1 Comparison of antimicrobial resistance of *N. gonorrhoeae* isolates from Shanghai: 2005/2008.**

**A. Resistance percentages:** PEN- penicillin, TET-tetracycline, CIP-ciprofloxacin, SPT-spectinomycin, CRO-ceftriaxone

**B. Plasmid or chromosomally-mediated resistance:** PPNG- Penicillanase-producing *N. gonorrhoeae* and TET MIC < 16.0 mg/L, TRNG- TET MIC  $\geq$  16.0 mg/L and non-PPNG, PP/TRNG- PPNG and TET MIC  $\geq$  16.0 mg/L, CMPR- PEN MIC  $\geq$  2.0 mg/L and TET MIC  $\leq$  1.0 mg/L and non-penicillinase producing, CMTR- TET MIC  $\geq$  2.0 mg/L and PEN MIC  $\leq$  1.0 mg/L and non-penicillinase producing, CMRNG- PEN MIC  $\geq$  2.0 mg/L and TET MIC  $\geq$  2.0 but  $\leq$  16.0 mg/L and non-penicillinase producing.

Stars indicate percentage difference between isolates from 2005 and 2008 is significant.



**Fig. 3.2** MIC distributions of *N. gonorrhoeae* isolates for CIP (A), SPT(B) and CRO (C).  
CIP- ciprofloxacin, SPT- spectinomycin, CRO- ceftriaxone



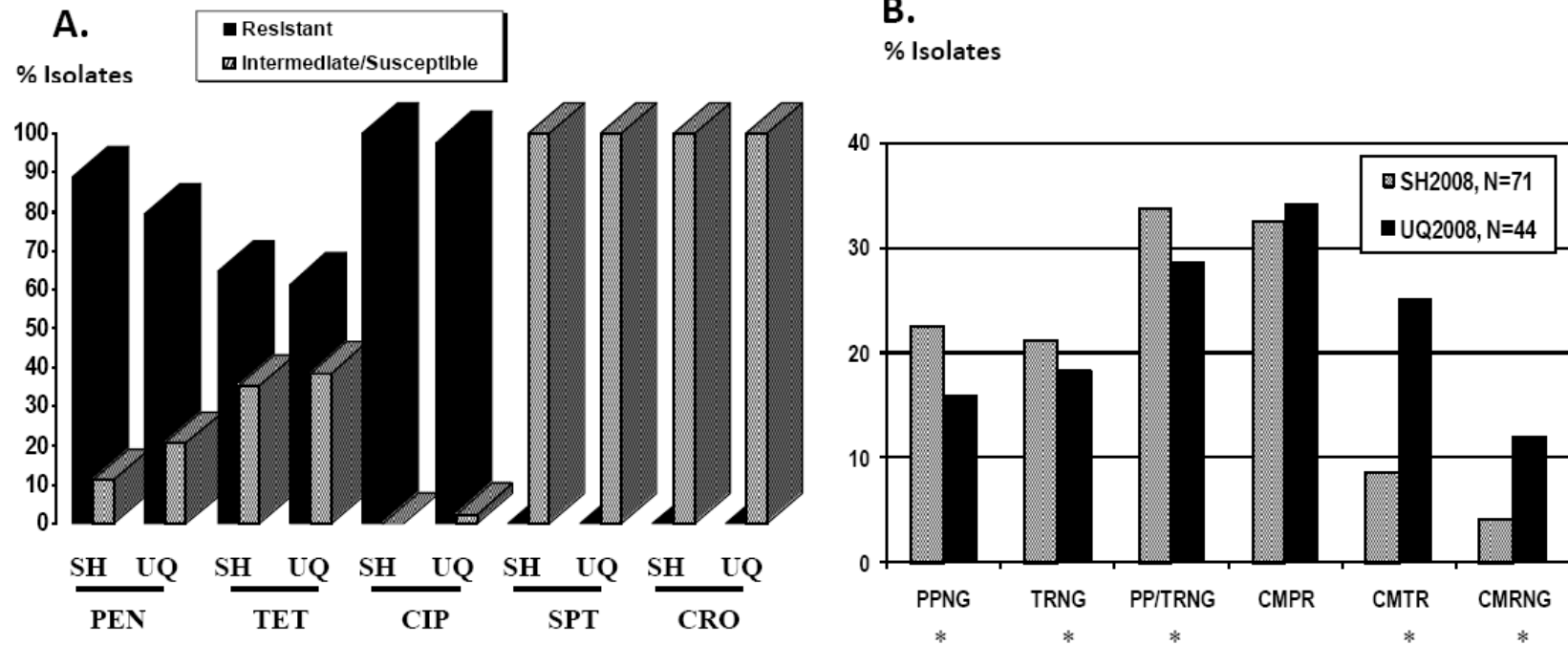
### 3.1.5 Geographic Distribution of Antimicrobial Resistance of *N. gonorrhoeae* Isolates: Shanghai/Urumschi

The majority of *N. gonorrhoeae* isolates in both cities were resistant to PEN, TET, and CIP. All isolates remained susceptible to SPT and CRO. The percentages of resistant isolates were not significantly different between the UQ2008 and SH2008 isolates ( $P>0.05$ ; **Fig. 3.3A**).

The SH2008 isolates had higher percentages of plasmid mediated resistance than the UQ2008 isolates (**Fig. 3.3B**). Among the SH2008 isolates, PPNG, TRNG, and PP/TRNG accounted for 22.5%, 22.5%, and 33.8%, respectively. Among the UQ2008 isolates, PPNG, TRNG and PP/TRNG accounted for 15.9%, 18.2%, and 28.6%, respectively.

The UQ2008 isolates had significantly higher percentages of CMTR (25.0%) and CMRNG (11.9%) as compared to the SH2008 isolates (CMTR 8.5%, CMRNG 5.6%). The percentages of CMPR isolates were not significantly different (32.4% for SH2008 vs 34.1% for the UQ2008 isolates;  $P>0.05$ ).

The MIC distributions of CIP, SPT, and CRO of the SH2008 and UQ2008 isolates were compared. A higher percentage of SH2008 isolates had CIP MICs  $\geq 8.0$  mg/L (39.4%) as compared to the UQ2008 isolates (29.5%; **Fig. 3.4A**). A significantly higher percentage (69.0%) of the SH2008 isolates than the UQ2008 isolates (54.5%) had SPT MICs of  $\geq 32$  mg/L (**Fig. 3.4B**). The CRO MIC curve for the SH2008 isolates was shifted to the right as compared to the UQ2008 isolates (**Fig. 3.4C**). Approximately 19.7% of the SH2008 isolates had CRO MICs of  $\geq 0.125$  mg/L, whereas 4.5% of the UQ2008 isolates had CRO MICs of  $\geq 0.125$  mg/L.

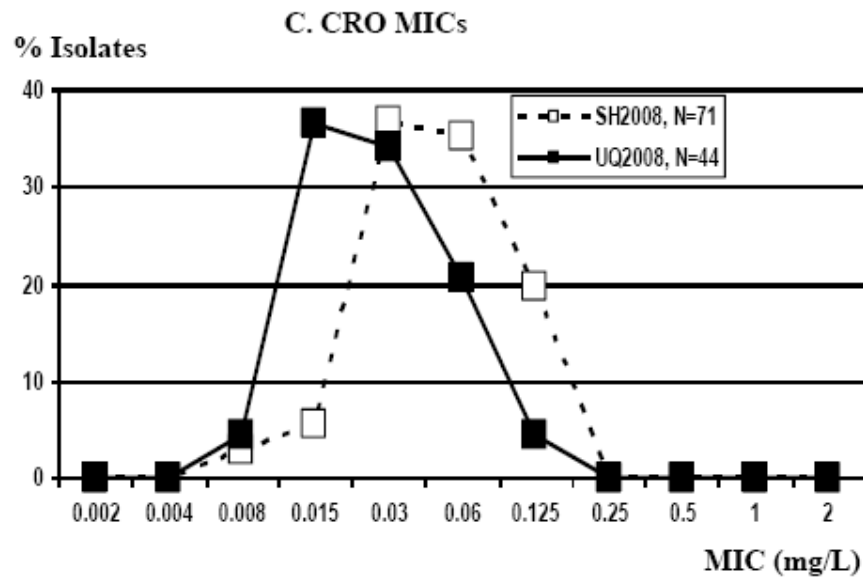
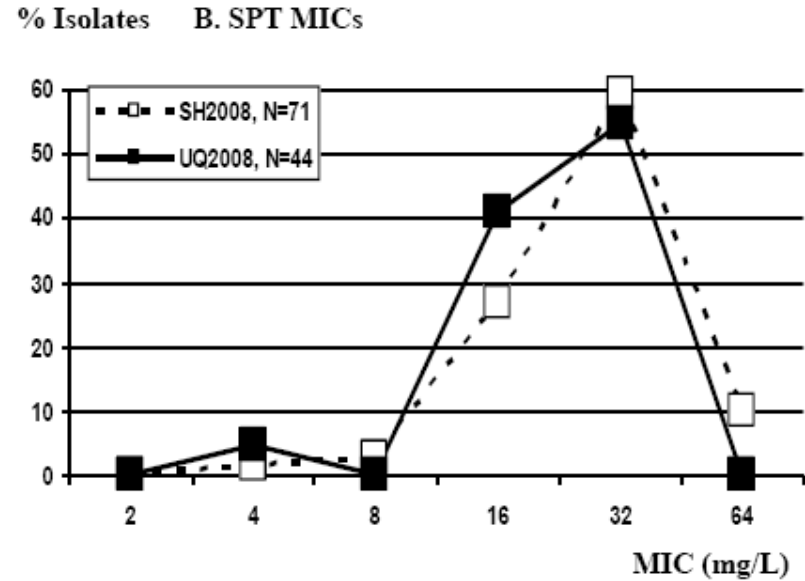
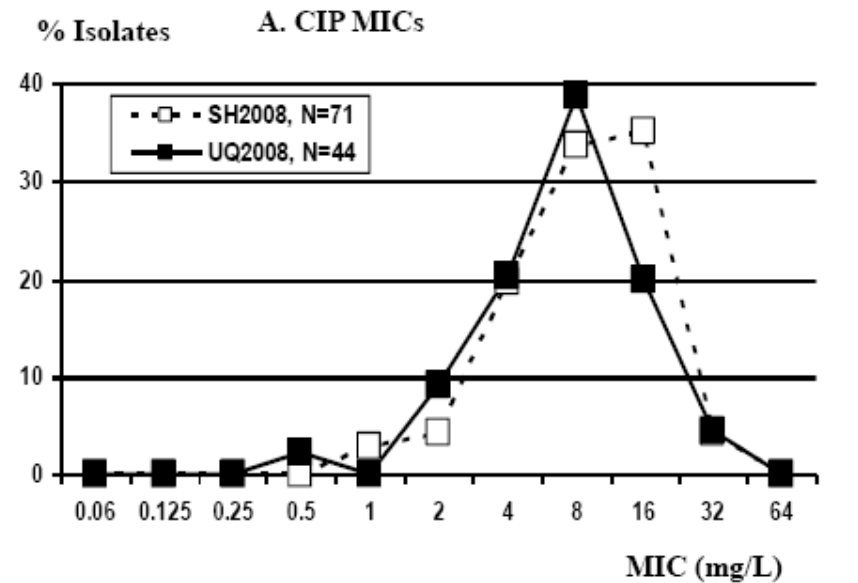


**Fig. 3.3 Comparison of antimicrobial resistance of *N. gonorrhoeae* isolates from Shanghai and Urumchi (2008).**

**A. Resistance percentages:** SH- Shanghai 2008 (SH2008, n=71), UQ- Urumchi 2007/2008 (UQ2008, n=44); PEN- penicillin, TET- tetracycline, CIP- ciprofloxacin, SPT- spectinomycin, CRO- ceftriaxone.

**B. Plasmid or chromosomally-mediated resistance:** PPNG- Penicillinase-producing *N. gonorrhoeae* and TET MIC < 16.0 mg/L, TRNG- TET MIC  $\geq$  16.0 mg/L and non-PPNG, PP/TRNG- PPNG and TET MIC  $\geq$  16.0 mg/L, CMPR- PEN MIC  $\geq$  2.0 mg/L and TET MIC  $\leq$  1.0 mg/L and non-penicillinase producing, CMTR- TET MIC  $\geq$  2.0 mg/L and PEN MIC  $\leq$  1.0 mg/L and non-penicillinase producing, CMRNG- PEN MIC  $\geq$  2.0 mg/L and TET MIC  $\geq$  2.0 but  $\leq$  16.0 mg/L and non-penicillinase producing.

Stars indicate the difference of percentage between the SH2008 and UQ2008 isolates was significant.

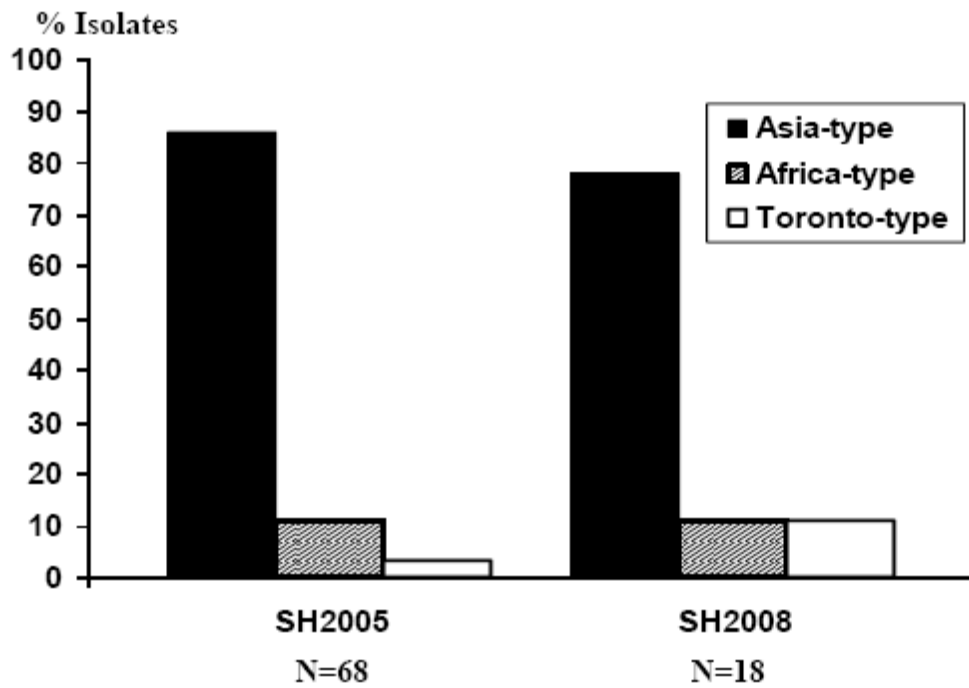


**Fig. 3.4** MIC distributions of CIP (A), SPT(B) and CRO (C).  
CIP- ciprofloxacin, SPT- spectinomycin, CRO- ceftriaxone.

### 3.1.6 Analysis of Gonococcal $\beta$ -lactamase-producing and *tetM*-containing Plasmids

Sixty-eight (SH2005) and 18 (SH2008) consecutive PPNG isolates were analyzed for types of  $\beta$ -lactamase producing plasmids using PCR methods (Dillon et al 1999). Three types of  $\beta$ -lactamase producing plasmids were observed (**Fig. 3.5**). For the SH2005 PPNG isolates (n=68), the Asia-type accounted for 86.8%, the Africa-type for 10.3%, and the Toronto-type for 2.9%. For the 2008 PPNG isolates (n=18), the Asia-type accounted for 77.8%, the Africa-type for 11.1%, and the Toronto-type for 11.1%. The distribution of plasmid types was not significantly different between the SH2005 and the SH2008 PPNG isolates ( $P>0.05$ ).

The types of *tetM*-containing plasmids (Xia et al 1995) were tested in 24 consecutive SH2005 and 14 consecutive SH2008 TRNG isolates. All *tetM*-containing plasmids exhibited a Dutch-type plasmid (data not shown).



**Fig. 3.5 Differentiation of  $\beta$ -lactamase producing plasmids in PPNG *N. gonorrhoeae* isolates.** The  $\beta$ -lactamase producing *N. gonorrhoeae* (PPNG) isolates were consecutively collected from the SH2005 or the SH2008 isolates. In total, 68 PPNG isolates from the SH2005 collection and 18 PPNG isolates from the SH2008 collection were analyzed.

## 3.2 Molecular Mechanisms of Antimicrobial Resistance in *Neisseria gonorrhoeae*

### 3.2.1 Gonococcal PorB Is Associated with Penicillin and Tetracycline Resistance

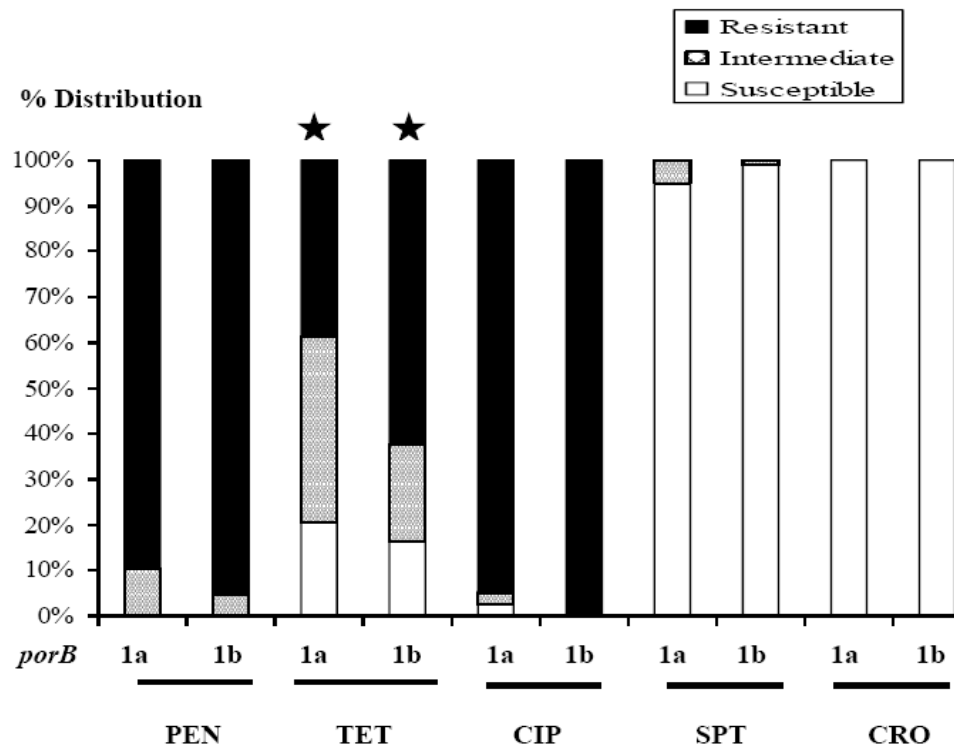
These results have been published in J Antimicrob Chemother (Liao et al 2008). Permission to use has been obtained from the Oxford University Press (**Appendix A2.4**).

#### 3.2.1.1 Association between *porB* Genotypes and Antimicrobial Resistance

One hundred and forty-three consecutive gonococcal isolates from male patients from Shanghai in 2005 were analyzed for association between *porB* genotypes and susceptibility to antimicrobial agents (**Fig. 3.6**).

The *N. gonorrhoeae* isolates included 39 isolates with a *porB1a* and 104 isolates with a *porB1b* genotype. Percentages of PEN resistance were 89.8% in *porB1a* isolates and 95.3% in *porB1b* isolates; percentages of CIP resistance were 91.5% in *porB1a* isolates and 99.2% in *porB1b* isolates. There was no significant difference in percentages of PEN and CIP resistance and carriage of *porB* alleles ( $P>0.05$ ). *porB1b* isolates had higher MIC<sub>50</sub>s to PEN (64.0 mg/L) than *porB1a* isolates (8.0 mg/L). Both the MIC<sub>50</sub> and MIC<sub>90</sub> to CIP were higher in *porB1b* isolates (MIC<sub>50</sub>=8.0 mg/L and MIC<sub>90</sub>=32.0 mg/L) than *porB1a* isolates (MIC<sub>50</sub>=4.0 mg/L and MIC<sub>90</sub>=8.0 mg/L). Percentages of TET resistance were 62.5% for *porB1b* and 38.4% for *porB1a* isolates. The percentage of TET resistance was significantly higher in *porB1b* isolates than that in *porB1a* isolates ( $P=0.025$ ).

More than 95% of the isolates were susceptible to SPT and all isolates were susceptible to CRO. There was no significant difference for SPT or CRO resistant percentages between *porB1b* and *porB1a* isolates. *porB1a* and *porB1b* isolates had the same MIC<sub>50</sub> to SPT (16.0 mg/L) or to CRO (0.03 mg/L).



**Figure 3.6 Association of antimicrobial susceptibility and *porB* genotypes of 143 *N. gonorrhoeae* isolates from male patients.** Bars indicate percentages of isolates which were classified as susceptible (white), intermediate (hatched) and resistant (black). PEN: penicillin, TET: tetracycline, CIP: ciprofloxacin, SPT: spectinomycin, and CRO: ceftriaxone. Stars indicate statistically significant difference of TET resistance between the two *porB* types. *porB*1a, n=39. *porB*1b, n=104.

### 3.2.1.2 Mutations of G120 and A121 in Gonococcal PorB

Mutations at codons G120 and A121 of gonococcal PorB proteins (i.e. PIB and PIA) are associated with decreased susceptibility to antibiotics (Olesky et al 2002, 2006). Of the 104 PIB isolates, 98.1% (102/104) carried mutations at codon G120: 84.6% (88/104) with a G120K mutation, 11.5% (12/104) with a G120D mutation, 1% (1/104) with a G120R, and 1% (1/104) with a G120N mutation. The majority of the PIB isolates (87.5%, 91/104) had mutations at codon A121: A121D (73.1%, 76/104), A121G (6.7%, 7/104), A121N (6.7%, 7/104), or A121H (1.0%, 1/104). Double mutations of PIB G120/A121 were observed in 86.5% (90/104) of the isolates, including G120K/A121D (71.1%, 74/104), G120K/A121G (6.7%, 7/104), G120K/A121N (5.7%, 6/104), G120K/A121H (1%, 1/104), G120R/A121D (1%, 1/104), and G120N/A121N (1%, 1/104). A single G120 mutation (G120D) was noted in 11.5% (12/104) of the sequences while a single A121 mutation, A121D, was observed in 1% (1/104). Two PIB isolates (2/104) did not carry any mutations at these two codons. Mutation G120R and A121N have not been reported previously (**Table 3.4**).

In the 39 PIA isolates, the G120 mutation, G120D, was observed in 82.1% (32/39) of the sequences while the rest (7/39) did not exhibit this mutation. All PIA isolates had a mutation at codon A121 (A121G). Double mutations of G120D/A121G were observed in 82.1% of PIA isolates, while 17.9% of PIA isolates had a single A121G mutation (**Table 3.4**).



**Table 3.4 Mutations at the residues G120 and A121 of *porB* in 143 *N. gonorrhoeae* isolates from Shanghai in 2005<sup>§</sup>**

Mutations in PorB	Number of <i>porB</i> 1b isolates (%)	Number of <i>porB</i> 1a isolates (%)
G120K/A121D	74 (71.1)	0
G120K/A121G	7(6.7)	0
G120K/A121N	6 (5.7)	0
G120R/A121D	1 (1.0)	0
G120K/A121H	1 (1.0)	0
G120N/A121N	1 (1.0)	0
G120D/A121A	12 (11.5)	0
G120G/A121D	1 (1.0)	0
G120G/A121A	1 (1.0)	0
G120D/A121G	0	32 (82.1)
G120G/A121G	0	7 (17.9)
Total isolates (%)	104 (100.0)	39 (100.0)

### 3.2.2 Association between Mutations in Multiple Loci and Reduced Susceptibility to Ceftriaxone in *N. gonorrhoeae*

#### 3.2.2.1 Antimicrobial Resistance Phenotypes

Ceftriaxone MICs of the CRO<sup>Red</sup> and CRO<sup>S</sup> *N. gonorrhoeae* isolates differed by at least 4 fold. The MIC<sub>50</sub>S and MIC<sub>90</sub>S to penicillin (PEN), tetracycline (TET), ciprofloxacin (CIP), or spectinomycin (SPT) for the two groups were within 2-fold dilutions (data not shown). All isolates were susceptible to SPT. There was no significant difference ( $P>0.05$ ) in the percentages of isolates resistant to PEN (CRO<sup>Red</sup> 100% vs CRO<sup>S</sup> 84.8%), TET (CRO<sup>Red</sup> 64.3% vs CRO<sup>S</sup> 54.3%), and CIP (CRO<sup>Red</sup> 100% vs CRO<sup>S</sup> 100%). Likewise, there was no significant difference ( $P>0.05$ ) in percentages of resistant phenotypes [PPNG (CRO<sup>Red</sup> 67.9% vs CRO<sup>S</sup> 50.0%), TRNG (CRO<sup>Red</sup> 32.1% vs CRO<sup>S</sup> 31.3%), PP/TRNG (CRO<sup>Red</sup> 21.4% vs CRO<sup>S</sup> 18.8%), CMPR (CRO<sup>Red</sup> 42.9% vs CRO<sup>S</sup> 31.2%), CMTR (CRO<sup>Red</sup> 31.3% vs CRO<sup>S</sup> 25.0%), and CMRNG (CRO<sup>Red</sup> 14.3% vs CRO<sup>S</sup> 9.4%)].

#### 3.2.2.2 *N. gonorrhoeae* porB1b is associated with CRO<sup>Red</sup>

The percentage of isolates carrying a PIB phenotype (**Table 3.5**) was significantly higher in CRO<sup>Red</sup> (89.3%, 25/28) isolates than that in CRO<sup>S</sup> (59.4%, 19/32) isolates ( $P=0.02$ ). In CRO<sup>Red</sup> PIB isolates (n=25), the amino acid substitutions observed at codons G120 and/or A121 included G120K/A121D (68.0%), G120K/A121N/G (20.0%), and G120D alone (12.0%). In CRO<sup>S</sup> PIB isolates (n=19), similar amino acid substitutions were observed –i.e. G120K/A121D (84.2%), G120K/A121N/G (5.3%), and G120D alone (5.3%). One CRO<sup>S</sup> PIB isolate had no mutations at codons G120 and A121. The mutation patterns at G120 and A121 were not significantly different between CRO<sup>Red</sup> and CRO<sup>S</sup> isolates which were PIB ( $P=0.78$ ) or PIA ( $P=0.92$ ).

#### 3.2.2.3 MtrR Mutations Differ between CRO<sup>Red</sup> and CRO<sup>S</sup> *N. gonorrhoeae* Isolates

The distribution of mutation patterns in MtrR was significantly different ( $P<0.001$ ) between CRO<sup>Red</sup> and CRO<sup>S</sup> isolates (**Table 3.6**). Notably, 50% of CRO<sup>Red</sup> isolates (14/28) exhibited a MtrR protein sequence identical to *N. gonorrhoeae* FA1090 MtrR (GenBank accession #YP\_208426, referenced to as wild type - WT), while only one CRO<sup>S</sup> isolate (3.6%, 1/32) displayed a WT MtrR.

**Table 3.5 Association between gonococcal PorB and reduced susceptibility to ceftriaxone (CRO) in *N. gonorrhoeae* isolates from Shanghai**

Mutations at residues G120 and A121 of PorB	CRO <sup>Red</sup> isolates n (%) <sup>a</sup>	CRO <sup>S</sup> isolates n (%) <sup>b</sup>	P
<b>PIB</b>			
G120K/A121D	17 (68.0)	16 (84.2)	0.78
G120K/A121N/G	5 (20.0)	1 (5.3)	
G120D	3 (12.0)	1 (5.3)	
No mutation	0 (0.0)	1 (5.3)	
Subtotal	25 (100.0)	19 (100.0)	
<b>PIA</b>			
G120D/A121G	3 (100.0)	10 (76.9)	0.92
A121G	0	3 (23.1)	
Subtotal	3 (100.0)	13 (100.0)	
<b>Overall (PIB vs PIA)</b>	<b>28 (100.0)</b>	<b>32 (100.0)</b>	<b>0.02*</b>

a. CRO<sup>Red</sup>: Reduced susceptibility to ceftriaxone (MIC=0.125–0.25 mg/L)

b. CRO<sup>S</sup>: susceptible to ceftriaxone (MIC=0.004–0.016 mg/L)

P: P values were determined by Chi-square tests.<sup>36</sup>

\*: P value for differences of percentages of PIA and PIB isolates among CRO<sup>Red</sup> and CRO<sup>S</sup> isolates.

**Table 3.6 Specific amino acid substitutions in gonococcal MtrR are associated with reduced susceptibility of *N. gonorrhoeae* isolates to ceftriaxone**

Mutations in MtrR	CRO <sup>Red</sup> isolates, n (%) <sup>a</sup>	CRO <sup>S</sup> isolates, n (%) <sup>b</sup>	P
<b>Overall (PIA and PIB)</b>			
WT <sup>†</sup>	14 (50.0)	1 (3.6)	<0.001 <sup>*</sup>
A39T/H105Y or G45D/H105Y	10 (35.7) <sup>c,d</sup>	0 (0.0)	
T86A	3 (10.7)	0 (0.0)	
A39T or G45D	1 (3.6)	15 (46.9)	
H105Y	0	14 (43.8)	
T86A/H105Y	0 (0.0)	2 (6.3)	
Total	28 (100.0)	32 (100.0)	
<b>PIA</b>			
WT	2 (66.7)	1 (7.7)	ND <sup>e</sup>
A39T/H105Y	1 (33.3)	0 (0.0)	
A39T or G45D	0 (0.0)	3 (23.1) <sup>d</sup>	
H105Y	0 (0.0)	7 (53.8)	
T86A/H105Y	0 (0.0)	2 (15.4)	
Subtotal	3 (100.0)	13 (100.0)	
<b>PIB</b>			
WT	12 (48.0)	0 (0.0)	<0.001
A39T/H105Y or G45D/H105Y	9 (36.0)	0 (0.0)	
T86A	3 (12.0)	0 (0)	
A39T or G45D	1 (4.0)	12 (63.2)	
H105Y	0 (0)	7 (36.8)	
Subtotal	25 (100.0)	19 (100.0)	

a. CRO<sup>Red</sup>: Reduced susceptibility to ceftriaxone (MIC = 0.125–0.25 mg/L)

b. CRO<sup>S</sup>: susceptible to ceftriaxone (MIC = 0.004–0.016 mg/L)

c. One isolate had a single nucleotide deletion at nt341 of *mtrR*, resulting in a truncated MtrR. This truncated MtrR also had an A39T/H105Y double mutation.

d. A deletion of 5 nucleotides at nt189-193 of *mtrR*, resulting in a truncated MtrR protein. This truncated MtrR also had an A39T mutation.

e. ND: Not determined because of small number of isolates.

†. WT- wild type using MtrR from *N. gonorrhoeae* FA1090 as a template

\*. To facilitate Chi-square tests, isolates with an A39T or G45D mutation were combined because both mutations were at the DNA binding domain of MtrR. Similarly, A39T/H105Y and G45D/H104Y were combined.

A39T/H105Y or G45D/H105Y mutations were present in CRO<sup>Red</sup> isolates (35.7%), but not in CRO<sup>S</sup> isolates. A T86A mutation was present in 3 CRO<sup>Red</sup> isolates, but not in CRO<sup>S</sup> isolates. CRO<sup>S</sup> isolates often carried a single A39T or G45D mutation (46.9%) in the DNA binding domain of MtrR, in contrast with only 1 CRO<sup>Red</sup> isolate. An H105Y single mutation was present in 43.8% of CRO<sup>S</sup> isolates, but was not present in CRO<sup>Red</sup> isolates.

Frame-shift mutations of gonococcal *mtrR* were observed in 3 isolates; 2 CRO<sup>Red</sup> isolates had a single nucleotide deletion at nt341 of *mtrR*, which would produce a truncated protein of 113 amino acids (this truncated protein also had an A39T/H105Y mutation). A CRO<sup>S</sup> isolate had a deletion of 5 nucleotides (nt189-193) in *mtrR*, which would produce a truncated MtrR of 62 amino acids, which also carried an A39T substitution.

The presence of a single nucleotide deletion (-A) in the 13bp inverted repeat of the *mtrR* promoter did not differentiate CRO<sup>Red</sup> from CRO<sup>S</sup> isolates ( $P > 0.05$ ). It was observed in 92.9% (26/28) of the CRO<sup>Red</sup> (2 CRO<sup>Red</sup> isolates without an “-A” deletion carried a truncated MtrR protein). This deletion was also observed in 90.6% (29/32) of the CRO<sup>S</sup> isolates [3 CRO<sup>S</sup> isolates without “-A” deletion had a G45D mutation (n=2) or carried a truncated MtrR (n=1)].

PorB type (i.e. PIA and PIB) was stratified in order to determine its association with MtrR mutations. Two of the 3 PIA CRO<sup>Red</sup> isolates had a WT MtrR and 1 isolate carried an A39T/H105Y mutation in its truncated MtrR, whereas most PIA CRO<sup>S</sup> isolates had A39T or G45D (23.1%, 3/13) or H105Y (53.8%, 7/13) single mutations in MtrR. The distribution of MtrR mutation patterns between CRO<sup>Red</sup> and CRO<sup>S</sup> isolates was significantly different ( $P < 0.001$ ) for isolates which were PIB. Most PIB CRO<sup>Red</sup> isolates had either a wild type (48.0%, 12/25), or double mutations of A39T/H105Y or G45D/H105Y (36.0%, 9/25) in MtrR, whereas the majority of PIB CRO<sup>S</sup> isolates carried A39T or G45D (63.2%, 12/19), or H105Y (36.8%, 7/19) single mutations.

#### **3.2.2.4 Mutation Patterns in PBP2 (*penA*)**

Mutations in the transpeptidase domain of PBP2 (AA340-570) have been implicated in reduced susceptibility to third-generation cephalosporins. All isolates in this study had an Asp-

346 insertion in PBP2 and all other amino acids between AA340 and AA500 of PBP2 were identical in both groups of isolates (data not shown).

There was considerable diversity between amino acid 501 and 570 of the PBP2 transpeptidase domain. Mutations in the region of AA501-570 were observed at 12 codons (**Fig. 3.7**): Ala-501, Phe-504, Ala-510, Ala-516, His-541, Gly-542, Pro-551, Pro-552, Lys-555, Ile-556, Ile-563, and Ile566. The A501V/T mutation was present more frequently in the CRO<sup>Red</sup> isolates (78.6%) as compared to isolates which were CRO<sup>S</sup> (46.9%; P=0.02). However, when stratified by PorB type (i.e. PIA or PIB), the percentages of A501V/T mutations were similar between the CRO<sup>Red</sup> and the CRO<sup>S</sup> isolates (P > 0.05, **Fig. 3.7**). All isolates of both groups contained F504L, A510V, and A516G mutations. Although mutations at the other 8 codons were present, their percentages between the CRO<sup>Red</sup> and CRO<sup>S</sup> isolates were not significantly different (P > 0.05).

Twenty-four polymorphism patterns (I-XXIV) of PBP2 between AA340-AA570 have been described previously (Ito et al 2005; Lee et al 2010; Whiley et al 2007a/b). Pattern X has been described as mosaic PBP2 (Ito et al 2005) but was not observed in either CRO<sup>Red</sup> or CRO<sup>S</sup> isolates in this study.

As shown in **Table 3.7**, the patterns encountered in our study included 6 novel patterns (XXV-XXX). CRO<sup>Red</sup> isolates (n=28) exhibited 11 polymorphism patterns: Pattern II/XVI (7.1%), V (10.7%), XIII (17.9%), XVII/XVIII (25.0%), XXI (10.7%), XXVII (10.7%), and XXIV, XXV, XXVI, XXVIII, XXIX (3.6% each). CRO<sup>S</sup> isolates (n=32) exhibited 8 polymorphism patterns: Pattern II/XVI (15.6%), V (21.9%), IX (12.5%), XXI (25.0%), XXVII (15.6%), and 1 (3.1%) isolate each for patterns IV, XVII/XVIII, and XXX.

Patterns XIII (17.9%), XXV (3.6%), XXVI (3.6%), XXVIII (3.6%) and XXIX (3.6%) were only present in CRO<sup>Red</sup> isolates, while Patterns IV (3.1%) and XXX (3.1%) were only present in CRO<sup>S</sup> isolates.

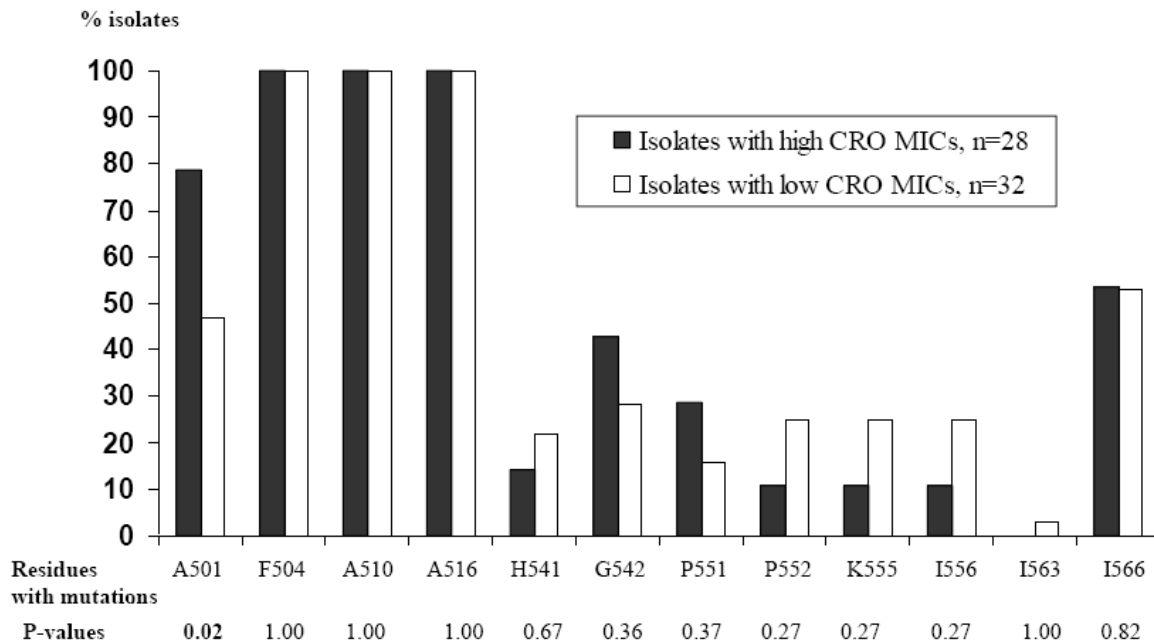
Notably, Patterns XIII (17.9%) and XVII/XVIII (25.0%) were more prevalent in the CRO<sup>Red</sup> isolates than in the CRO<sup>S</sup> isolates (P<0.001), and these patterns contained combinations of

mutations of A501V/P551S or A501V/G542S. Patterns V and XXI accounted for a larger proportion of CRO<sup>S</sup> isolates (46.9%, 15/32) as compared to CRO<sup>Red</sup> isolates (21.4%, 6/28) (P=0.04). Patterns V and XXI did not have combined mutations of A501V/P551S or A501V/G542S (pattern V did not have A501V although it had G542S, and pattern XXI did not have P551S/L or G542S although it had A501V).

Isolates (CRO<sup>Red</sup> or CRO<sup>S</sup>) were stratified by PorB type to analyze whether mutations in PBP2 were associated with PorB type. Forty-four percent of PIB CRO<sup>Red</sup> isolates (n=25) exhibited mutation patterns XIII (16.0%, 4/25) or XVII/XVIII (28.0%, 7/25), while the PIB CRO<sup>S</sup> isolates (n=19) were mostly pattern XXI (31.6%, 6/19). The 3 PIA CRO<sup>Red</sup> isolates exhibited patterns IX, XIII and XXV, respectively, while 13 PIA CRO<sup>S</sup> isolates were pattern II or XVI (23.1%, 3/13), V (30.8%, 4/13), IX (7.7%, 1/13), XXI (15.4%, 2/13), and XXVII (23.1%, 3/13).

### **3.2.2.5 L421P Mutation in PBP1 (*ponA*) Is Not Associated with CRO<sup>Red</sup>**

All the CRO<sup>Red</sup> isolates and 97.0% of the CRO<sup>S</sup> isolates carried a L421P mutation in PBP1 (P>0.05). One CRO<sup>S</sup> isolate had double L421P/A375T mutations as well as a PIA phenotype. Another CRO<sup>S</sup> isolate did not have mutations in PBP1 and exhibited a PIA phenotype. No other amino acid substitutions were observed in gonococcal PBP1 in this study.



**Fig. 3.7 Amino acid mutations in the transpeptidase domain of gonococcal PBP2.** Amino acid substitutions between AA340 to AA570 were determined. Percentages of mutations at various residues were presented for CRO<sup>Red</sup> (MICs=0.125–0.25 mg/L, closed bars) or CRO<sup>S</sup> isolates (MICs=0.004–0.016 mg/L, open bars). P values were determined using the Yates Chi-square test and P < 0.05 was in bold.



**Table 3.7 Mutation patterns of gonococcal PBP2 in CRO<sup>Red</sup> and CRO<sup>S</sup> isolates from Shanghai**

Mutation patterns in PBP2 <sup>a</sup>	Amino acid substitutions at the transpeptidase domain	CRO <sup>Red</sup> Isolates n (%)	CRO <sup>S</sup> Isolates n (%)	Total n (%)
II OR XVI <sup>b</sup>	F504L, A510V, A516G	2 (7.1)	5 (15.6)	7 (11.7)
IV	F504L, A510V, A516G, G542S	0 (0)	1 (3.1)	1 (1.7)
V	F504L, A510V, A516G, G542S, I566V	3 (10.7)	7 (21.9)	10 (16.7)
IX	F504L, A510V, A516G, P551L	1 (3.6)	4 (12.5)	5 (8.3)
XIII	A501V, F504L, A510V, A516G, P551S	5 (17.9)	0 (0)	5 (8.3)
XVII/XVIII	A501V, F504L, A510V, A516G, G542S, I566V	7 (25.0)	1 (3.1)	8 (13.3)
XXI	A501V, F504L, A510V, A516G, H541N, P552V, K555Q, I556V, I566V	3 (10.7)	8 (25.0)	11 (18.3)
XXV	A501T, F504L, A510V, A516G, G542S	1 (3.6)	0 (0)	1 (1.7)
XXVI	A501V, F504L, A510V, A516G, G542S, P551S, I566V	1 (3.6)	0 (0)	1 (1.7)
XXVII	A501V, F504L, A510V, A516G	3 (10.7)	5 (15.6)	8 (13.3)
XXVIII	A501V, F504L, A510V, A516G, I566V	1 (3.6)	0 (0)	1 (1.7)
XXIX	A501V, F504L, A510V, A516G, H541Y	1 (3.6)	0 (0)	1 (1.7)
XXX	A501T, F504L, A510V, A516G, G542S, I563V	0 (0)	1 (3.1)	1 (1.7)
Total		28 (100)	32 (100)	60 (100)

a: Mutation patterns were determined based on amino acid substitutions in the regions of AA340 to AA570 of *N. gonorrhoeae* PBP2.

b: Pattern II and XVI, and pattern XVII and XVIII had identical amino acid substitutions within the region of AA340-AA570 of PBP2.

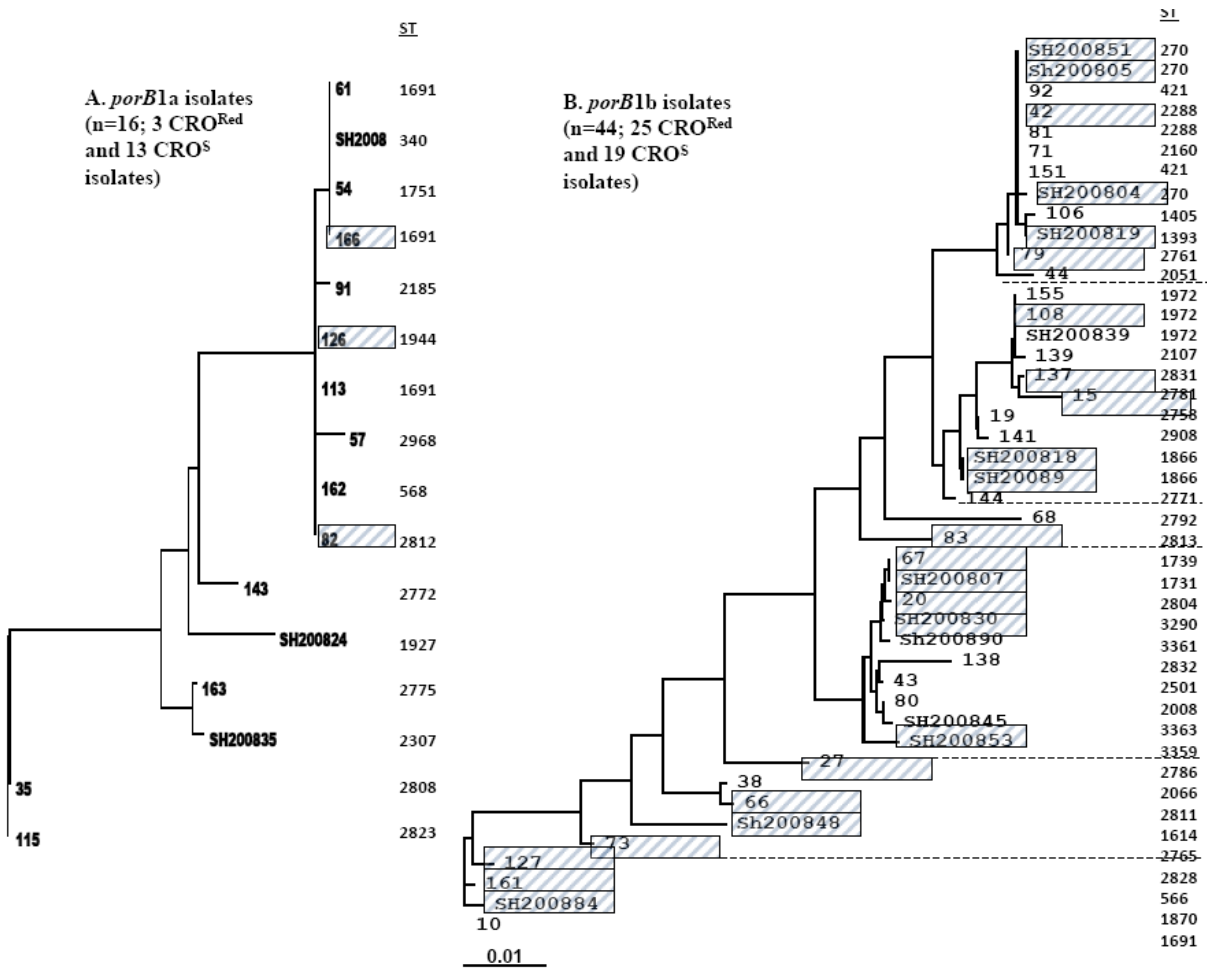
CRO<sup>Red</sup>: Reduced susceptibility to ceftriaxone (MIC=0.125–0.25 mg/L)

CRO<sup>S</sup>: Susceptible to ceftriaxone (MIC=0.004–0.016 mg/L)

### 3.2.2.6 Clustering of CRO<sup>Red</sup> Isolates Based on *porB* DNA Sequence and NG-MAST Analysis

To determine whether isolates having reduced susceptibility to ceftriaxone are clonal, extended-length *porB*-based sequence analysis and *N. gonorrhoeae* Multi-Antigen Sequence Typing (NG-MAST) were performed as described in the Method section.

The *porB* sequence types and NG-MAST sequence types of the *N. gonorrhoeae* isolates, either exhibiting reduced susceptibility (CRO<sup>Red</sup>) or being susceptible (CRO<sup>S</sup>) to ceftriaxone, were diverse (**Fig. 3.8**). The 3 *porB1a* CRO<sup>Red</sup> isolates exhibited 2 different *porB* sequences and 3 NG-MAST STs, while the 13 *porB1a* CRO<sup>S</sup> isolates exhibited 10 *porB* sequences and 10 NG-MAST STs. The 25 *porB1b* CRO<sup>Red</sup> isolates displayed 20 different *porB* sequences, dispersing along the entire *porB* 1b phylogenetic tree and 21 NG-MAST STs with the largest ST (#270) comprising 3 isolates. The 19 *porB1b* CRO<sup>S</sup> isolates included 16 *porB1b* sequences, which were dispersed among the *porB1b* sequences of the CRO<sup>Red</sup> isolates along the phylogenetic tree, and 18 NG-MAST STs (ST421 comprising 2 isolates while all other STs had a single isolate). Three STs (ST1691, ST1972 and ST2288) were present in both the CRO<sup>Red</sup> and the CRO<sup>S</sup> isolates, while other STs were observed only in one susceptibility class or the other. Therefore, the CRO<sup>Red</sup> and the CRO<sup>S</sup> isolates are non-clonal.



**Fig. 3.8 Clonality analysis of gonococcal isolates with reduced susceptibility to ceftriaxone.**

**A. *porB1a* isolates (n=16); 3 isolates were CRO<sup>Red</sup> and 13 isolates were CRO<sup>S</sup>.**

**B. *porB1b* isolates (n=44); 25 isolates were CRO<sup>Red</sup> and 19 were CRO<sup>S</sup>.**

Analysis was conducted using *porB*-based typing and NG-MAST analysis as described in the method section. Phylogenetic trees were generated based on *porB* DNA sequences using the Clustal X program.

CRO<sup>Red</sup> isolates (MICs = 0.125–0.25 mg/L) were highlighted by hatched boxes while CRO<sup>S</sup> (MICs = 0.004–0.016 mg/L) isolates were on white background.

Isolate number is shown at the tip of the tree branches, and NG-MAST ST is indicated for each isolate on the right. The distance of horizontal lines was proportional to nucleotide variations of *porB* sequences. Isolates on the same vertical lines had identical *porB* sequences.

### 3.2.3 Analysis of Quinolone Resistant Determinant Regions (QRDRs) in *N. gonorrhoeae* Isolates

#### 3.2.3.1 Mutation Patterns in QRDRs in *N. gonorrhoeae* Isolates in Shanghai in 2005

Part of these results has been published in J Antimicrob Chemother (Yang et al 2006). Permission to use has been obtained from the Oxford University Press (**Appendix A2.3**).

A total of 103 consecutive *N. gonorrhoeae* isolates collected in 2005 from male patients in Shanghai were analyzed. The isolates include 1 susceptible (S), 1 intermediately susceptible (I) and 101 resistant (R) to ciprofloxacin (CIP).

The QRDR mutation profiles are shown in **Table 3.8**. The single CIP<sup>S</sup> isolate tested did not carry mutations in its QRDRs of *gyrA* or *parC* (mutation pattern P0), while the CIP<sup>I</sup> isolate carried a D95A mutation in *gyrA* and an S87N mutation in *parC* (pattern P1). All CIP<sup>R</sup> isolates carried an S91F mutation in the QRDR of *gyrA*, while others also contained A92P (3/103, 2.9%) and D95A/G (85/103, 82.5%) mutations. Single, double, or triple mutations in *gyrA* accounted for 15.5%, 83.5%, and 0.1% of the 103 *N. gonorrhoeae* isolates, respectively. *parC* mutations occurred in 74.8% of the isolates tested at codons S87 and E91 including S87R (45/103, 43.7%) or S87N/I/C (27/103, 26.2%). Single substitutions at S87 were more commonly found in isolates with *parC* mutations (69/103, 67.0%), while mutations at E91 accounted for 7.8% of the isolates (8/103).

Mutations in QRDRs were grouped into 19 patterns (**Table 3.8**). The most predominant patterns, accounting for 65.0% of the 103 isolates tested, included P3, P8, P9, and P15, with mutations at S91 and D95 of *gyrA* and a single or no mutation at S87 of *parC*. Isolates with patterns P2, P3, P4, and P16 (24.3%) contained *gyrA* but no *parC* mutations. Other patterns were characterized by either one substitution in both *gyrA* and *parC* (P1, P5 and P6), 2 mutations in *gyrA* and 1 mutation in *parC* (P7, P8, P9, P10, P11, P14, P15 and P17), double mutations in both *gyrA* and *parC* (P12, P13), 3 *gyrA* and 1 *parC* mutations (P18), or 1 *gyrA* and 2 *parC* mutations (P19).

**Table 3.8 QRDR mutation patterns in 103 *N. gonorrhoeae* Isolates from Shanghai**

Mutation patterns	GyrA			ParC		No. of isolates (%)	Ciprofloxacin MIC (mg/L)
	S91	A92	D95	S87	E91		
P0	- <sup>a</sup>	-	-	-	-	1(1.0)	0.06 <sup>b</sup>
P1	-	-	A	N	-	1(1.0)	0.5 <sup>c</sup>
P2	F	-	-	-	-	4(3.9)	1-16
<b>P3</b>	F	-	A	-	-	<b>13(12.6)</b>	1-32
P4	F	-	G	-	-	7(6.8)	2-32
P5	F	-	-	R	-	5(4.8)	16-32
P6	F	-	-	I	-	5(4.8)	2-≥64
P7	F	-	A	-	A	3(2.9)	1-32
<b>P8</b>	F	-	A	R	-	<b>24(23.3)</b>	2-32
<b>P9</b>	F	-	A	N	-	<b>16(15.5)</b>	2-16
P10	F	-	A	I	-	1(1.0)	8,16
P11	F	-	A	C	-	1(1.0)	2
P12	F	-	A	I	A	1(1.0)	32
P13	F	-	A	N	G	1(1.0)	2
P14	F	-	G	-	G	2(1.9)	2,8
<b>P15</b>	F	-	G	R	-	<b>14(13.6)</b>	2-≥64
P16	F	P	-	-	-	1(1.0)	2
P17	F	P	-	R	-	1(1.0)	32
P18	F	P	G	R	-	1(1.0)	2
P19	F	-	-	N	G	1(1.0)	16
Total						103(100.0)	0.06-≥64

QRDR: Quinolone resistance determinant region

a: No mutation at that residue.

b: The ciprofloxacin susceptible isolate without a mutation in the QRDRs was defined as Pattern P0.

c: The isolate having an “intermediate” MIC to ciprofloxacin exhibiting a QRDR mutation pattern P1.

Predominant patterns P3, P8, P9 and P15 are in bold.

### 3.2.3.2 Quantitative Association between MIC to Ciprifloxacin and Mutations in the Quinolone Resistant Determinant Regions

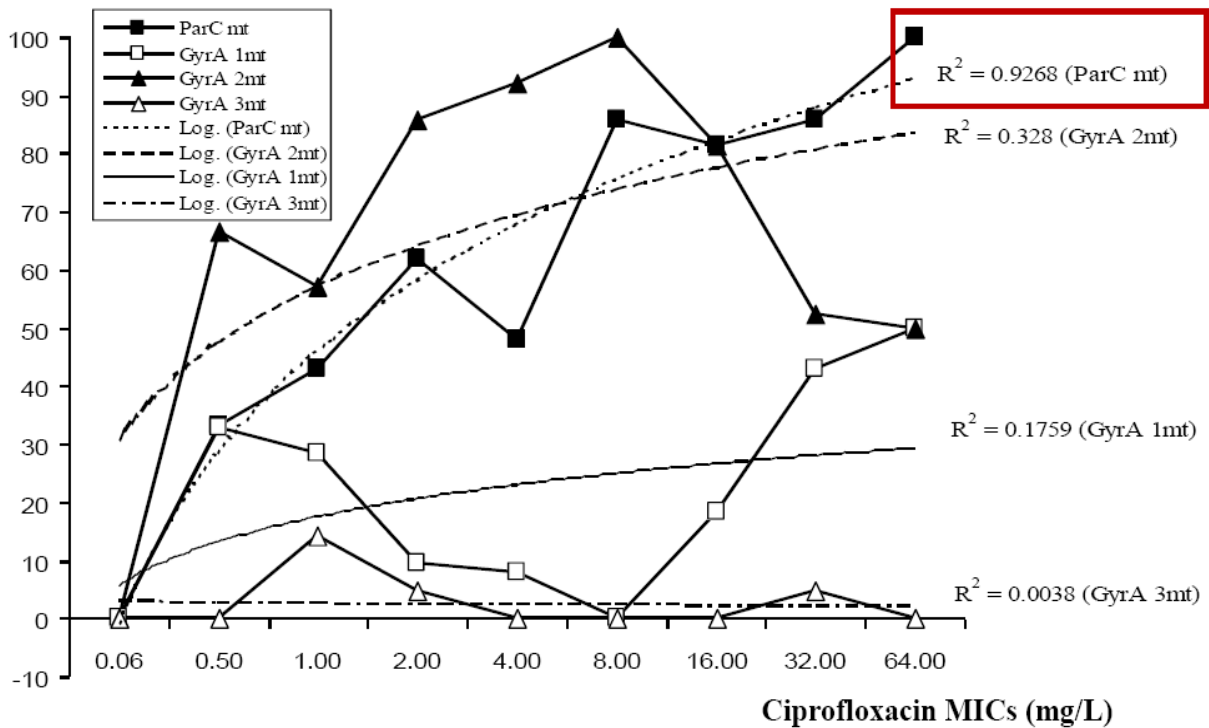
Regression correlation analysis was conducted to quantitatively determine the association between mutation patterns in QRDRs and the CIP MICs in *N. gonorrhoeae* isolates (**Fig. 3.9**). The correlation coefficient, represented as  $R^2$ , was 0.1759 for isolates having a single amino acid mutation, 0.328 for isolates with 2 amino acid mutations, and 0.0038 for isolates having 3 amino acid substitutions in GyrA QRDR. There was no association between the number of amino acid mutations in GyrA QRDR and CIP MICs ( $P>0.05$ ). The presence of mutations in ParC QRDR was significantly associated with high CIP MICs ( $R^2 = 0.9258$ ,  $P<0.01$ ).

### 3.2.3.3 Temporal Trends of QRDR Mutation Patterns in *N. gonorrhoeae* Isolates in Shanghai: 2005/2008

QRDR mutation patterns in CIP<sup>R</sup> *N. gonorrhoeae* isolates collected from Shanghai in 2008 (n=68) were compared to those in CIP<sup>R</sup> isolates from Shanghai in 2005. All CIP<sup>R</sup> isolates collected in 2008 (SH2008) contained a mutation at codons S91 and D95 of GyrA, and 75% of the SH2008 CIP<sup>R</sup> isolates had mutations at codon S87. The percentages of mutations at codons S91, D95 of GyrA, and S87 of ParC were similar to the SH2005 CIP<sup>R</sup> isolates ( $P>0.05$ ). The S88P mutation in ParC was observed in the SH2008 CIP<sup>R</sup> isolates but not in the SH2005 CIP<sup>R</sup> isolates (**Fig. 3.10A**).

In the SH2008 CIP<sup>R</sup> isolates, 10 QRDR mutation patterns were observed, with an average of 6.8 isolates per mutation pattern (**Fig. 3.10B**). By comparison, 17 QRDR mutation patterns were observed in the SH2005 CIP<sup>R</sup> isolates (n=101), with an average of 5.9 isolates per mutation pattern. Several common patterns were observed in both surveys (P3, P4, P8, P9, P14, and P15), but other patterns observed in the SH2005 CIP<sup>R</sup> isolates were not observed in the SH2008 CIP<sup>R</sup> isolates. Nine SH2008 CIP<sup>R</sup> isolates had 4 new mutation patterns as compared to the mutation patterns of the SH2005 CIP<sup>R</sup> isolates; these new patterns included mutations of S91F/D95A in GyrA and S87R/S88P in ParC (5 isolates), or S91F/D95N in GyrA and none or S87/or E91G in ParC (4 isolates).

% Isolates



**Fig. 3.9 Correlation of Ciprofloxacin MICs and Mutations of QRDRs in *N. gonorrhoeae* Isolates.**

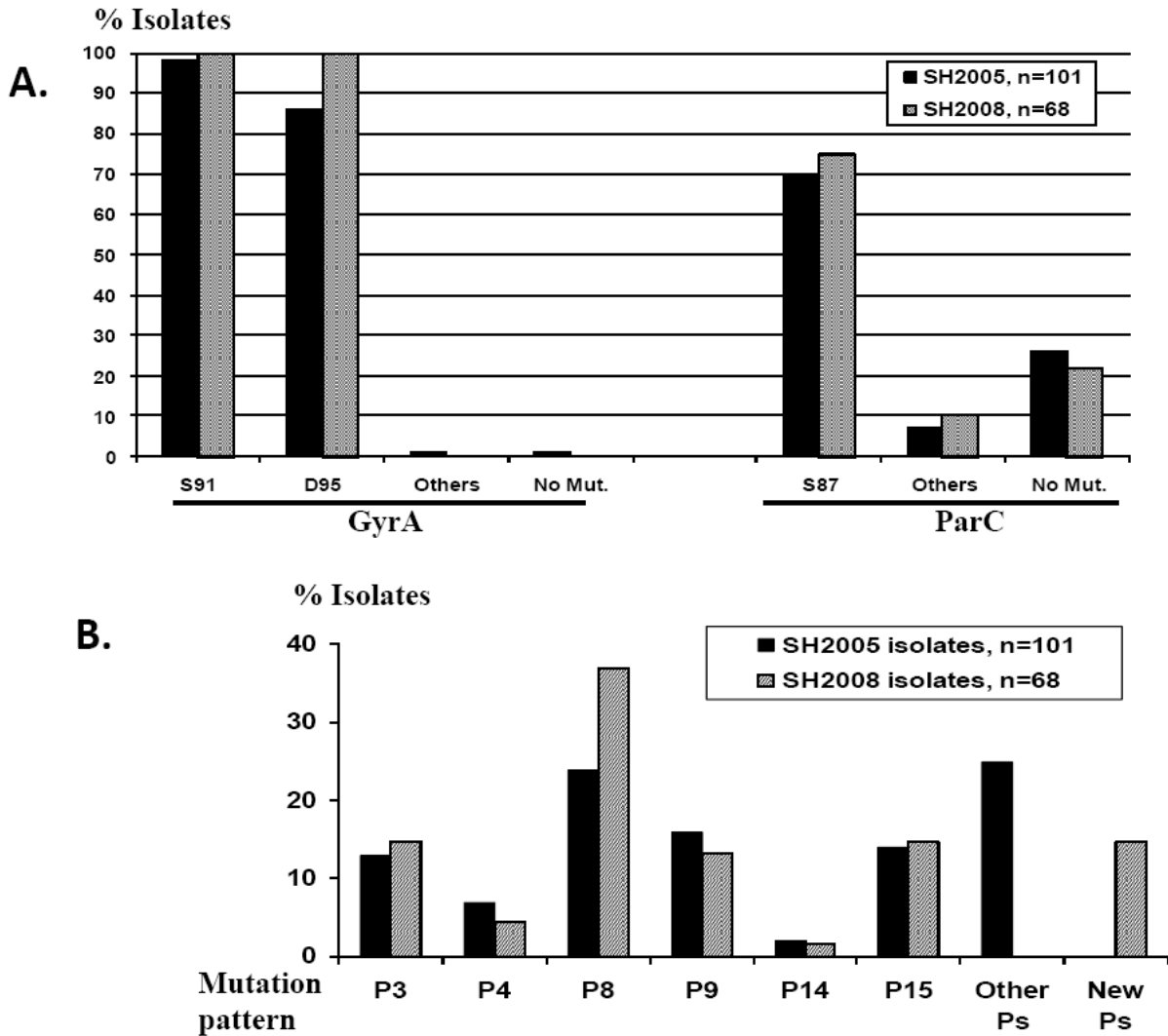
QRDR: quinolone resistance determinant region.

ParC mt indicated any mutations in ParC QRDRs. GyrA 1mt, 2mt and 3m indicated as isolates having 1, 2 or 3 amino acid substitutions in GyrA QRDR, respectively.

R: correlation coefficient generated with logarithmic regression.

Bold lines represent CIP MIC distributions of the isolates. Projected regression associations are shown in regular or dashed lines.

Red open box: Significant association.



**Fig. 3.10 Trends of QRDR mutations in ciprofloxacin resistant *N. gonorrhoeae* isolates in Shanghai: 2005/2008.**

**A. Comparison of residue mutation percentages.** Others- A92P (SH2005) in GyrA, S88P (SH2008) and E91G (both SH2005 and SH2008) in ParC. No Mut.- no mutations.

**B. Comparison of QRDR mutation patterns.** Other mutation patterns of QRDRs for SH2005 isolates were shown in Table 3.8, including P5-7, P10-13, P16-19. There are 4 new mutation patterns of QRDRs for the SH2008 CIPR isolates as compared those for the SH2005 CIPR isolates



### 3.3 Molecular Epidemiology of *Neisseria gonorrhoeae* in China

#### 3.3.1 Phylogenetic Analysis of *N. gonorrhoeae* Isolates Based on *porB* DNA Sequences

*N. gonorrhoeae* isolates used in this study included 174 isolates (143 from male index patients and 31 from female sex partners) from Shanghai in 2005 (SH2005), 81 isolates (68 from male index patients and 13 from female sex partners) from Shanghai in 2008 (SH2008), and 44 isolates (male patients only) from Urumchi in 2007-2008 (UQ2008).

Isolates from patients with sexual contacts revealed at the interview were described as “dyad” (two isolates from a male patient and one female patient, respectively, who reported having sexual contact.) or “triad” (three isolates from a male patient and two female patients, respectively. Both female patients had sexual contact with the male patient reported at the interview).

##### 3.3.1.1 *porB*-based Strain Diversity of 174 *N. gonorrhoeae* Isolates in Shanghai in 2005

These results have been published in J Antimicrob Chemother (Liao et al 2008). Permission for use has been obtained from the Oxford University Press (**Appendix A2.4**).

The index of discrimination (ID) of the *porB*-based typing method for the 174 isolates from 2005 was 95.0%.

Among the 174 *N. gonorrhoeae* isolates (SH2005), 47 isolates (27.0%) had a *porB1a* genotype and 127 isolates (73.0%) exhibited a *porB1b* genotype (**Table 3.9**). In total 77 unique *porB* DNA sequences were identified, with an average of 2.3 isolates per *porB* sequence.

The 47 *porB1a* isolates exhibited 15 *porB* DNA sequences. Two large clusters of *N. gonorrhoeae* isolates were identified: one comprised 15 isolates with 2 dyads, and the other one contained 14 isolates including 2 dyads and 1 triad. Two other clusters comprised 5 isolates

including a dyad and 2 isolates (a dyad), respectively. Eleven isolates, all from male patients, each had a distinct *porB1a* sequence.

The 127 *porB1b* isolates exhibited 62 sequences. A large cluster was identified which comprised 33 isolates including 5 dyads. Two clusters each comprised 5 isolates. Another two clusters each comprised 4 isolates. Nineteen *porB* sequences each comprised 2 isolates including 13 dyads. The other 38 isolates each exhibited a distinct *porB* sequence.

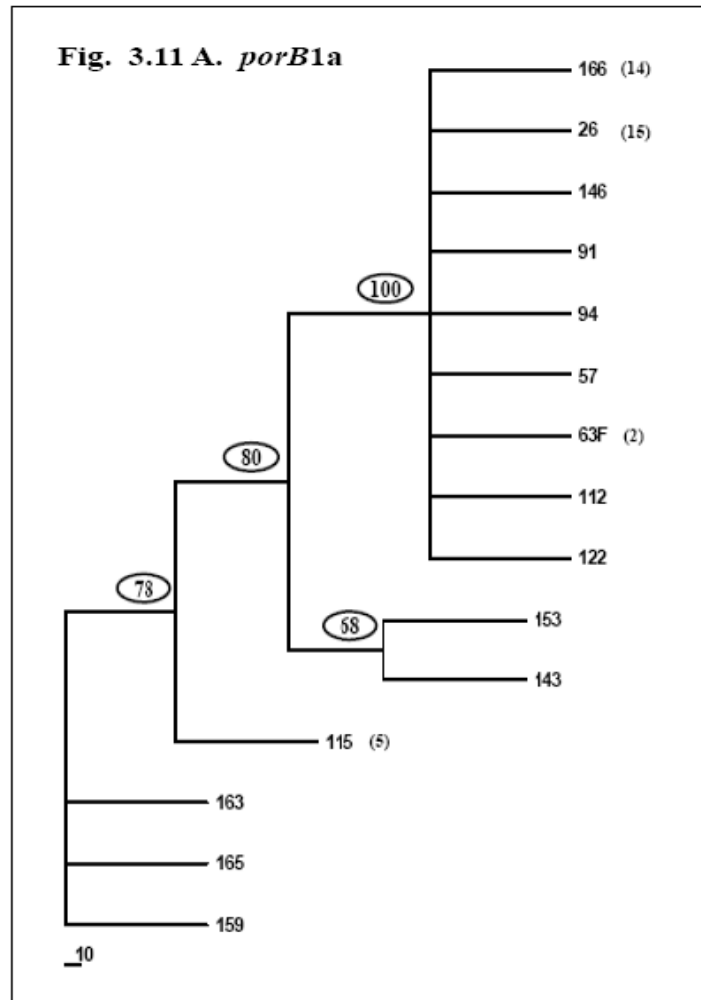
Phylogenetic analysis of the 15 *porB1a* sequences revealed that there were 3 nodes along the main trunk of the lineages and a node within the branches, based on a bootstrap value of higher than 50. Thus 4 clades formed in this group of 47 isolates, and the largest clade comprised 78.7% (37/47) of the *porB1a* isolates (**Fig. 3.11 A**).

DNA sequences of the 127 *porB1b* isolates were first divided into two groups (Group 1 and 2) based on clustering of neighbor joining trees in Clustal W analysis. *porB* DNA sequences of these 2 groups were separately subjected to phylogenetic analysis using the PAUP program. In Group 1, there were 7 nodes along the main trunk of the lineages and 2 nodes within the branches with a bootstrap value of higher than 50 (**Fig. 3.11 B**). There were 10 clades in Group 1 *porB1b* isolates; the largest clade comprised 38 isolates (29.9%, 38/127), 33 of which had an identical *porB1b* sequence. In Group 2, there were 5 nodes along the main trunk of the lineages and 2 nodes within the branches with a bootstrap value of higher than 50 (**Fig. 3.11 C**). There were 7 clades in Group 2 *porB1b* isolates. Therefore, the 127 *porB1b* isolates were phylogenetically divided into 16 clades based on a bootstrap value of > 50.

**Table 3.9 *porB*-based clustering of 174 *N. gonorrhoeae* isolates from Shanghai in 2005**

Sequence	Assigned isolate number
<b><i>porB1a</i> (47 isolates, 15 sequences)</b>	
1 sequence comprised 14 isolates	2,9,54, <u>56,56F</u> , <u>61,61F</u> , <u>75,75F1,75F2</u> , 86,129,160, 166
1 sequence comprised 15 isolates	<u>26,26F3,30,82,113,120,123,124,125,126,132,145, 156, 162,162F</u>
1 sequence comprised 5 isolates	18,35,115, <u>164,164F</u>
1 sequence comprised 2 isolates	<u>63,63F</u>
11 sequences each comprised a single isolate (11 isolates)	57,91,94,146,112,122,143,153,159,163,165
<b><i>porB1b</i> (127 isolates, 62 sequences)</b>	
1 sequence comprised 33 isolates	5,17,25, <u>34,34F</u> , 42,52, <u>64,64F</u> , 71,70, 74, 81,87, <u>89,89F</u> , 90,92,93, 97, <u>101,101F</u> , 104,109,110, <u>134,134F</u> , <u>135,135F</u> , 140,147,152,151
2 sequences each comprised 5 isolate: (10 isolates)	10,29, <u>53,53F</u> ,148 12,16,23,67,169
2 sequences each comprised 4 isolates (8 isolates)	58,41F,46,130,60, <u>118,118F</u> , 161
19 sequences each comprised 2 isolates (38 isolates)	<u>8, 8F,72,72F</u> , <u>78,78F</u> , <u>83,83F,107,107F</u> , <u>116,116F</u> , <u>158,158F</u> , <u>11,11F</u> , <u>32,32F</u> , <u>37,37F</u> , <u>103,103F</u> , <u>150,150F</u> , <u>73,73F</u> ; (155,108),(79,44),(106,7),(45,141F),(80,157),(149,65)
38 sequences each comprised a single isolate (38 isolates)	4F,19,39,50,68,76,114,117F,121,137,139,141, 144,3,27,28,31,38,41F,47,55,66,119,127,131, 13,20,21,22,33,43,77,95,102,105,133,136,138

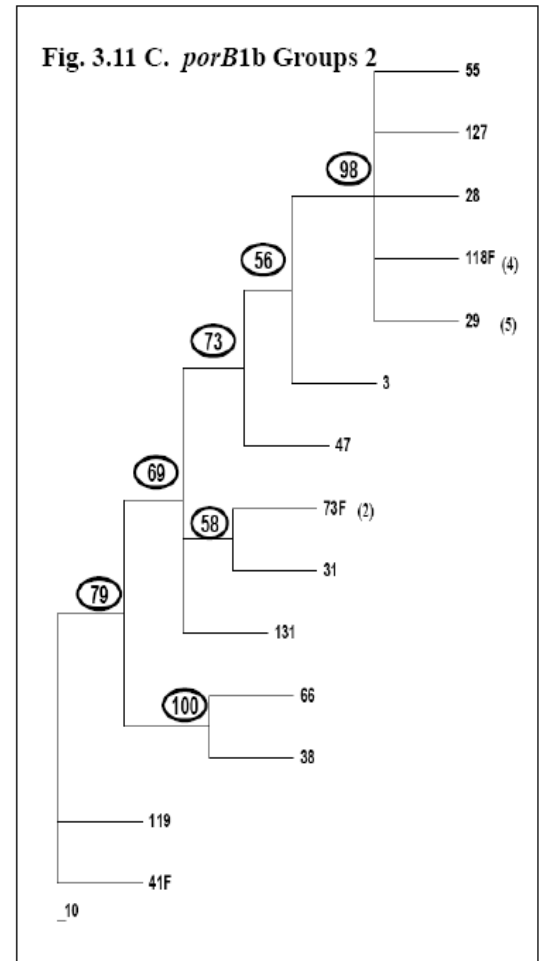
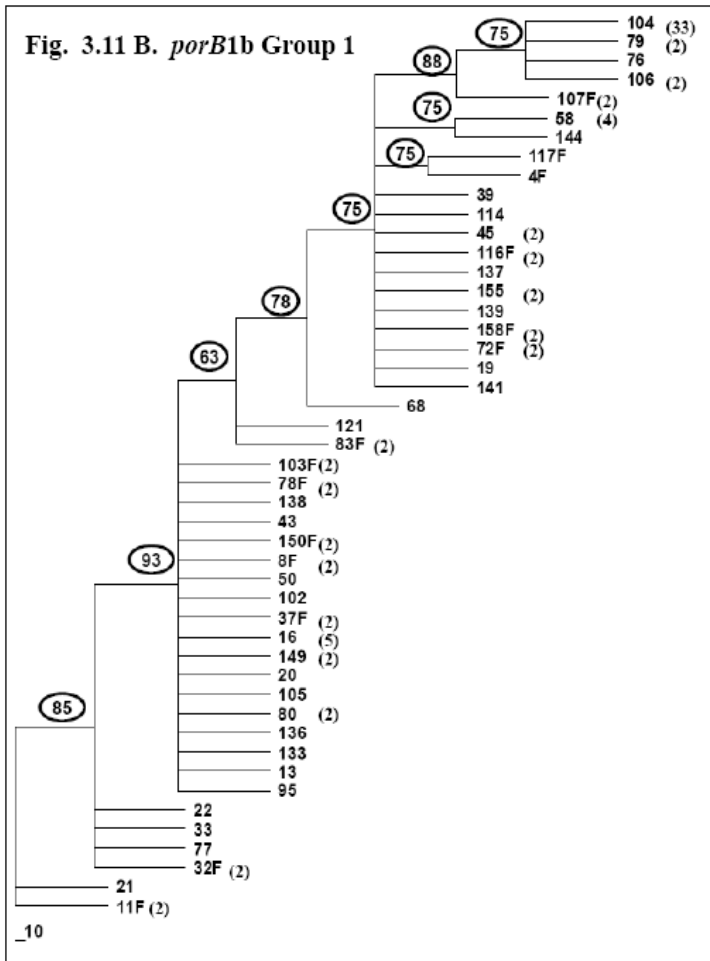
Isolates underlined were from gonorrhea patients having sexual contact. F - females.



**Fig. 3.11 *porB*-based phylogenetic analysis of 174 *N. gonorrhoeae* isolates from 2005.**

**A. *porB1a* sequences**

Phylogenetic analysis was conducted using the PAUP program. Tree was figured and presented in Treeview. Branch lengths are shown proportional to the amount of change along the branches. The scale distance bar indicates the number of nucleotide substitutions per site. Bootstrap values greater than 50% are shown in circles over the branches. A representative isolate number for *porB* sequences is shown at the tips of branches; and the number of isolates with identical sequences is shown adjacent to the representative isolate.



**Fig. 3.11** *porB*-based phylogenetic analysis of 174 *N. gonorrhoeae* isolates from 2005.

**B. Group 1 of *porB1b* sequences, C. Group 2 of *porB1b* sequences.**

Phylogenetic analysis was conducted using the PAUP program. Tree was figured and presented in Treeview. Branch lengths are shown proportional to the amount of change along the branches. The scale distance bar indicates the number of nucleotide substitutions per site. Bootstrap values greater than 50% are shown in circles over the branches. A representative isolate number for *porB* sequences is shown at the tips of branches; and the number of isolates with identical sequences is shown adjacent to the representative isolate.

### 3.3.1.2 *porB*-based Strain Diversity of 81 *N. gonorrhoeae* Isolates in Shanghai in 2008

The index of discrimination (ID) of *porB* DNA sequence typing for these *N. gonorrhoeae* isolates was 96.8%. Among the 81 *N. gonorrhoeae* isolates, 10 isolates (12.3%) were identified to have a *porB1a* genotype and 71 isolates (87.7%) had a *porB1b* genotype (**Table 3.10**). In total, 39 *porB* sequences were identified, with an average of 2.1 isolates per *porB* sequence.

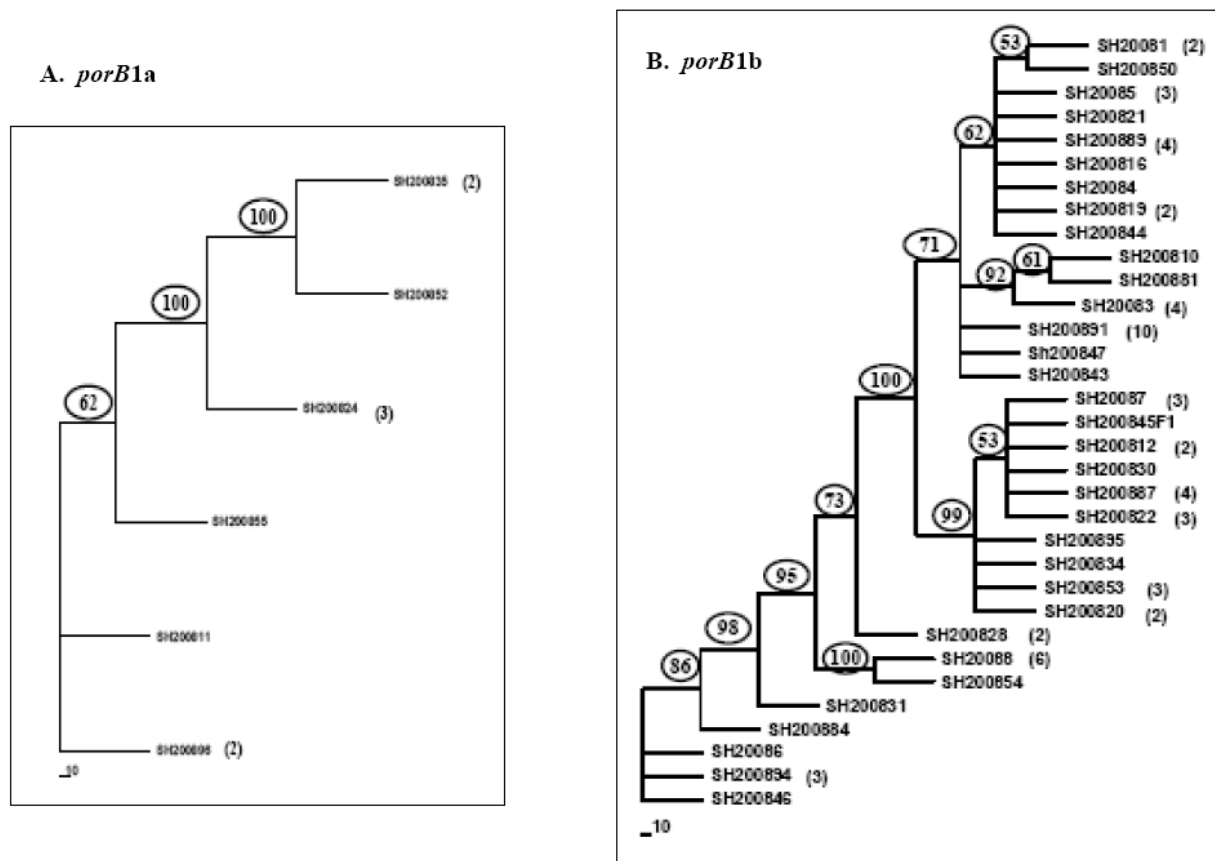
The 10 *porB1a* isolates exhibited 6 unique DNA sequences. A cluster of 3 isolates had an identical *porB1a* sequence, and two other clusters each comprised 2 isolates. The other 3 isolates each had a distinct *porB1a* sequence. The 71 *porB1b* isolates exhibited 33 sequences. Each of 18 DNA sequences comprised a single isolate, whereas the remaining 15 sequences comprised  $\geq 2$  isolates. Two large clusters comprised 10 isolates and 6 isolates (including a dyad), respectively. There were 3 sequences that each comprised 4 isolates. Five sequences each had 3 isolates, and another 5 sequences each comprised 2 isolates. The remaining 18 isolates each displayed a distinct sequence.

Phylogenetic analysis of 6 *porB1a* sequences revealed that there were 3 nodes along the main trunk of the lineages with a bootstrap value of higher than 50. Thus 4 clades formed in this group of 10 isolates (**Fig. 3.12 A**). Among the 33 *porB1b* sequences, there were 8 nodes along the main trunk of the lineages and 5 nodes within the branches with a bootstrap value of higher than 50 (**Fig. 3.12 B**). Therefore, the 71 *porB1b* isolates were phylogenetically divided into 13 clades based on a bootstrap value of higher than 50.

**Table 3.10 porB-based clustering of 81 *N. gonorrhoeae* isolates from Shanghai in 2008**

Sequence	Assigned isolate number
<b><i>porB1a</i> (10 isolates, 6 sequences)</b>	
1 sequence contained 3 isolates	200824, <u>200832,200832F1</u>
2 sequences each comprised 2 isolates (4 isolates)	SH200811,SH200836F1, <u>SH200835,SH200835F1</u>
3 sequences each contained a single isolate (3 isolates)	SH200896,SH200855,SH200852
<b><i>porB1b</i> (71 isolates, 33 sequences)</b>	
1 sequence contained 10 isolates	SH200891,SH200893,SH200836,SH200825,SH200818,SH200815,SH200814,SH200813,SH20089,SH20082
1 sequence contained 6 isolates	<u>SH20088,SH20088F2</u> , SH200817,SH200840,SH200842,SH200882
3 sequences each contained 4 isolates (12 isolates)	SH20083, <u>SH300839,SH200839F1</u> , SH200810 SH200889, <u>SH200897,SH200897F1</u> , SH200881F1 SH200887,SH200888,SH200890,SH200892
5 sequences each contained 3 isolates (15 isolates)	SH20085,SH200826,SH200851 SH20087, <u>SH200886,SH200886F1</u> <u>SH200822,SH22F1,SH22F2</u> Sh200853, SH200856,SH200856F1 <u>SH200894,SH200894F1,SH200894F7</u>
5 sequences each contained 2 isolates (10 isolates)	<u>SH20081,SH20081F1</u> SH200819,SH200838 SH200812,SH200841 <u>SH200820,SH200820F1</u> SH200828,SH200848
18 sequences each comprised a single isolate (18 isolates)	SH200850,SH200821,SH200816,SH200884,SH200844, SH200810,SH200881,SH200847,SH200843,SH200845F1, SH200830,SH200895,SH200834,SH200854,SH200831, SH200884,SH20086,SH200846

Isolates underlined were from gonorrhea patients having sexual contact. F – isolates from female patients.



**Fig. 3.12 *porB*-based phylogenetic analysis of 81 *N. gonorrhoeae* isolates from Shanghai in 2008.**

**A. *porB1a* sequences, C. *porB1b* sequences**

Phylogenetic analysis was conducted using the PAUP program. Tree was figured and presented in Treeview. Branch lengths are shown proportional to the amount of change along the branches. The scale distance bar indicates the number of nucleotide substitutions per site. Bootstrap values greater than 50% are shown in circles over the branches. A representative isolate number for *porB* sequences is shown at the tips of branches; and the number of isolates with identical sequences is shown adjacent to the representative isolate.



### 3.3.1.3 *porB*-based Strain Diversity of 44 *N. gonorrhoeae* Isolates in Urumchi

The index of discrimination (ID) of *porB* DNA sequence typing for these *N. gonorrhoeae* isolates was 93.2%.

Among the 44 *N. gonorrhoeae* isolates, 16 isolates (36.4%) had *porB1a* genotypes and 28 isolates (63.6%) had *porB1b* genotypes (**Table 3.11**). In all, 23 *porB* sequences were identified, with an average of 1.9 isolates per *porB* sequence.

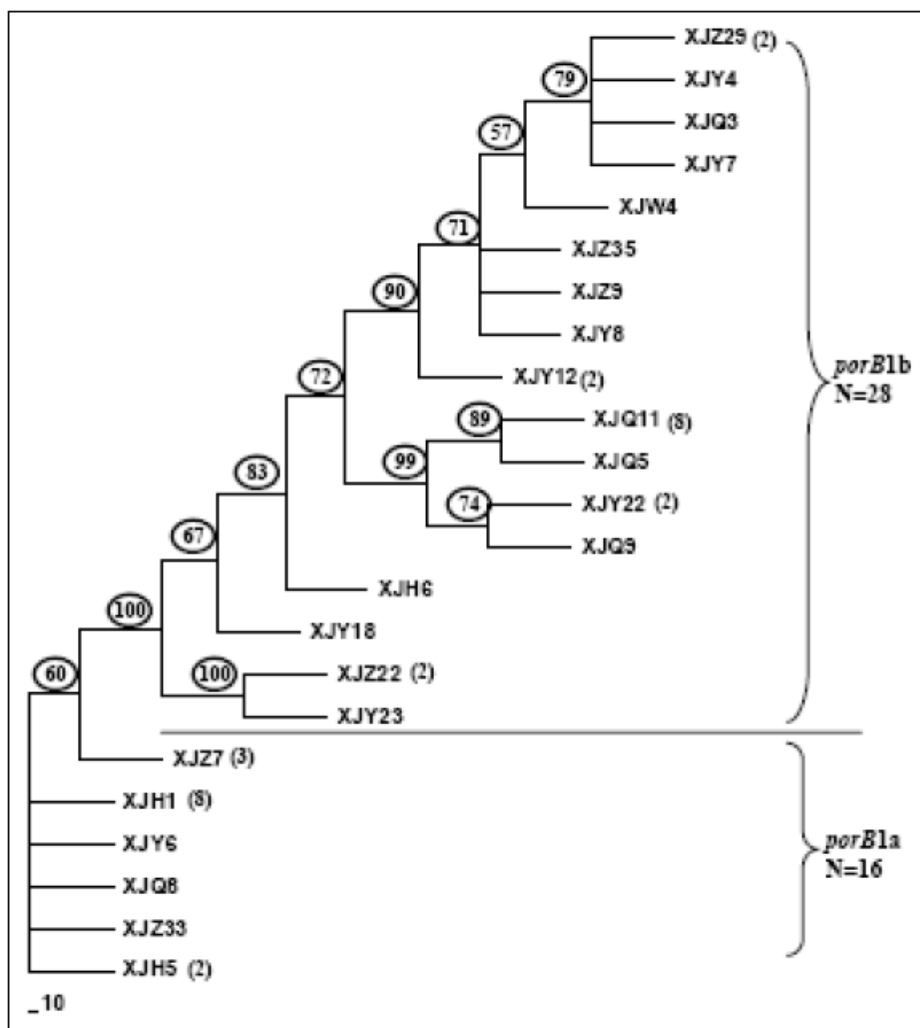
The 16 *porB1a* isolates exhibited 6 sequences. A large cluster of 8 isolates had an identical *porB* sequence. Two sequences comprised 3 and 2 isolates, respectively. The remaining 3 *porB1a* sequences each comprised a single isolate.

The 28 *porB1b* isolates displayed 17 *porB1b* sequences. A large cluster of 8 isolates had an identical *porB1b* sequence. Four sequences each comprised 2 isolates. The remaining 12 sequences each comprised a single isolate.

Phylogenetic analysis of the 6 *porB1a* sequences revealed that there was 1 node with a bootstrap value of higher than 50. Thus 2 clades formed for the 16 *porB1a* isolates (**Fig. 3.13**). Among the 17 *porB1b* sequences, there were 7 nodes along the main trunk of the lineages and 3 nodes within the branches, which had bootstrap values of higher than 50.

**Table 3.11 porB-based clustering of 44 *N. gonorrhoeae* isolates from Urumchi in 2007-2008**

Sequence	Assigned isolate number
<b><i>porB1a</i> (n=16 isolates, 6 sequences)</b>	
1 sequence comprised 8 isolates	XJH1,XJY1,XJY9,XJY11,XJY16,XJY13+,XJY15,XJQ19
1 sequence comprised 3 isolates	XJZ7,XJZ8,ZJY21
1 sequence comprised 2 isolates	XJH5,XJH7
3 sequences each comprised a single isolate (3 isolates)	XJZ33,XJQ8,XJY6
<b><i>porB1b</i> (n=28 isolates, 17 sequences)</b>	
1 sequence comprised 8 isolates	XJQ11,XJQ22,XJQ10,XJY24,XJY20,XJY3,XJZ34,XJZ21
4 sequences each comprised 2 isolate: (8 isolates)	XJZ29,XJZ30 XJY12,XJY19 XJZ22,XJZ23 XJY22,XJQ4
12 sequences each comprised a single isolate (12 isolates)	XJY23,XJY18,XJZ35,XJY8,XJZ9,XJW4,XJY7,XJQ3, XJY4,XJH6,XJQ9,XJQ5



**Fig. 3.13 *porB*-based phylogenetic analysis of 44 *N. gonorrhoeae* isolates from Urumchi in 2007-2008.**

Phylogenetic analysis was conducted using the PAUP program. Tree was figured and presented in Treeview. Branch lengths are shown proportional to the amount of change along the branches. The scale distance bar indicates the number of nucleotide substitutions per site. Bootstrap values greater than 50% are shown in circles over the branches. A representative isolate number for *porB* sequences is shown at the tips of branches; and the number of isolates with identical sequences is shown adjacent to the representative isolate.

#### 3.3.1.4 Temporal Strain Distribution of *N. gonorrhoeae* in Shanghai: 2005/2008

To determine temporal trends of *N. gonorrhoeae* strain distribution, *porB* sequences for the SH2005 and SH2008 isolates were combined (SH2005/2008 *porB1a* and SH2005/2008 *porB1b*) for phylogenetic analysis using the PAUP software.

All *porB1a* sequences for the SH2008 isolates were distinct from those observed in the SH2005 isolates. *porB1a* sequences of the two surveys dispersed along the phylogenetic tree. However, the largest *porB1a* clusters for the SH2005 and the SH2008 isolates were placed in distant clades (**Fig. 3.14 A**).

*porB1b* sequences for SH2005 and SH2008 isolates were divided into 3 data sets based on Clustal W neighbor joining trees for ease of analysis using the PAUP program. *porB1b* sequences of the two surveys dispersed along the phylogenetic trees (**Fig. 3.14 B-D**). Approximately 76% of the SH2008 sequences (25/33) differed from the SH2005 sequences; only 8 SH2008 sequences (24%, 8/33) comprising 14 isolates (20%, 14/71) were also present in the SH2005 isolates. The largest *porB1b* cluster, comprising 10 SH2008 isolates (12.3%), was unique as compared to the SH2005 isolates (**Fig. 3.14 B**). The largest *porB1b* cluster for the SH2005 isolates (19%, 33/174) was only observed in 3 SH2008 isolates (3.7%, 3/81).

Fig. 3.14 A. *porB1a*

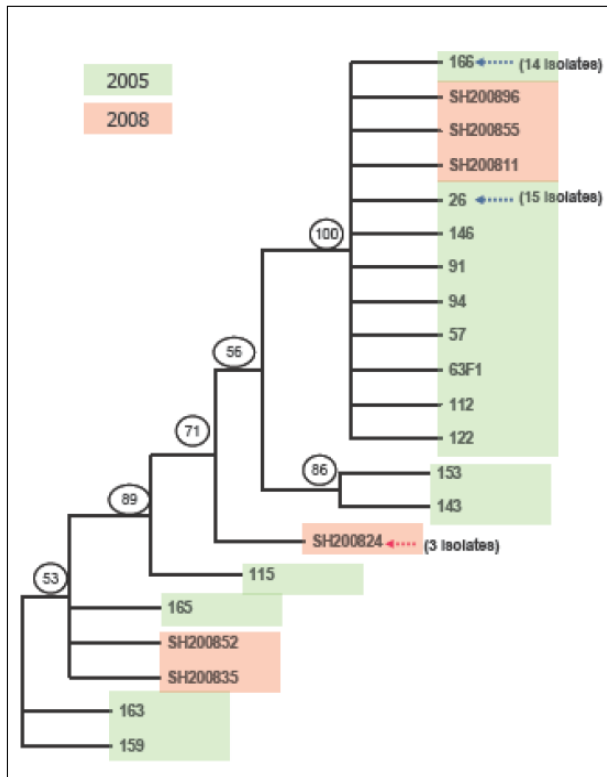
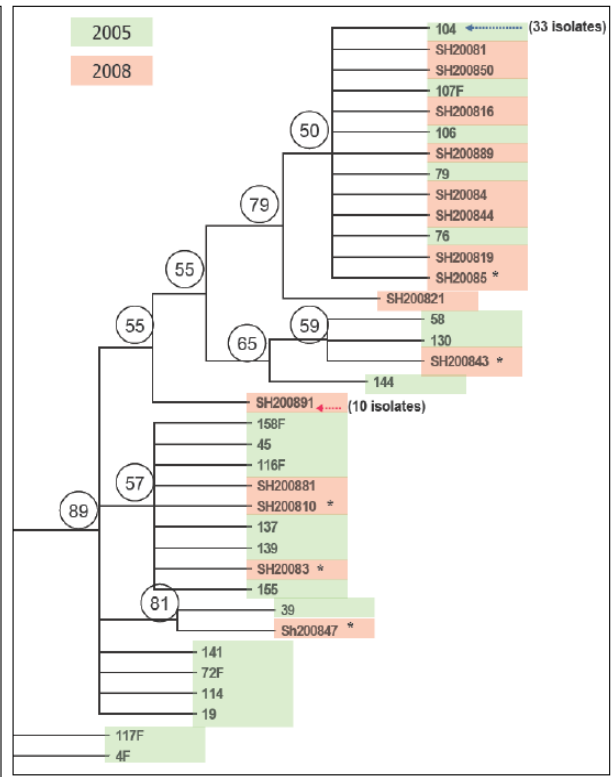


Fig. 3.14 B. *porB1b* Group 1



**Fig. 3.14 Temporal strain distribution of *N. gonorrhoeae* in Shanghai based on *porB* DNA sequences: 2005/2008**

**A. *porB1a* sequences, B. Group 1 *porB1b* sequences**

Phylogenetic analysis was conducted using the PAUP program. Tree was figured and presented in Treeview. Branch lengths are shown proportional to the amount of change along the branches. The scale distance bar indicates the number of nucleotide substitutions per site. Bootstrap values greater than 50% are shown in circles over the branches.

The SH2005 sequences are highlighted in blue and the SH2008 sequences highlighted in pink. Dashed arrows indicate the sequence contained highest number of isolates for *porB1a* isolates (a) and *porB1b* isolates (b-d).

Stars on the SH2008 sequences indicate that those sequences were also present in the SH2005 isolates. The SH2008 sequences without a star indicate a novel sequence as compared to the SH2005 isolates.

Fig. 3.14 C. *porB1b* Group 2

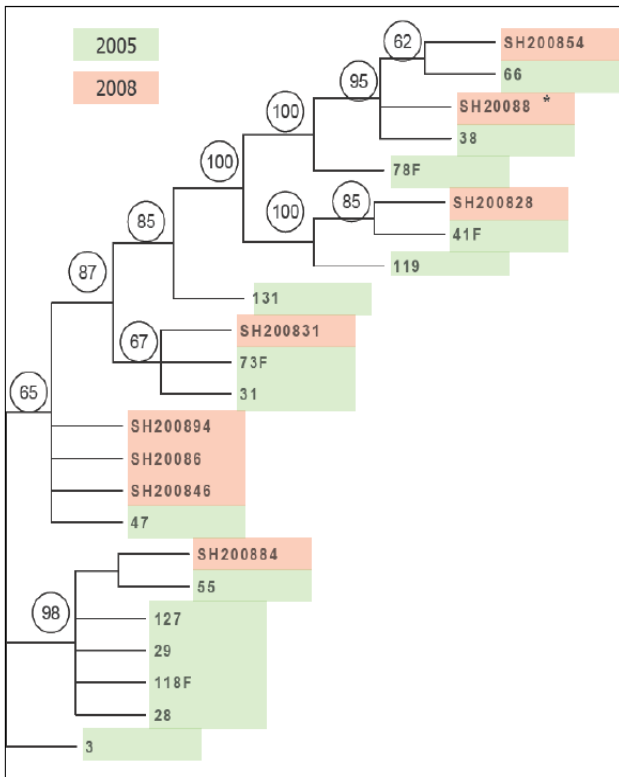
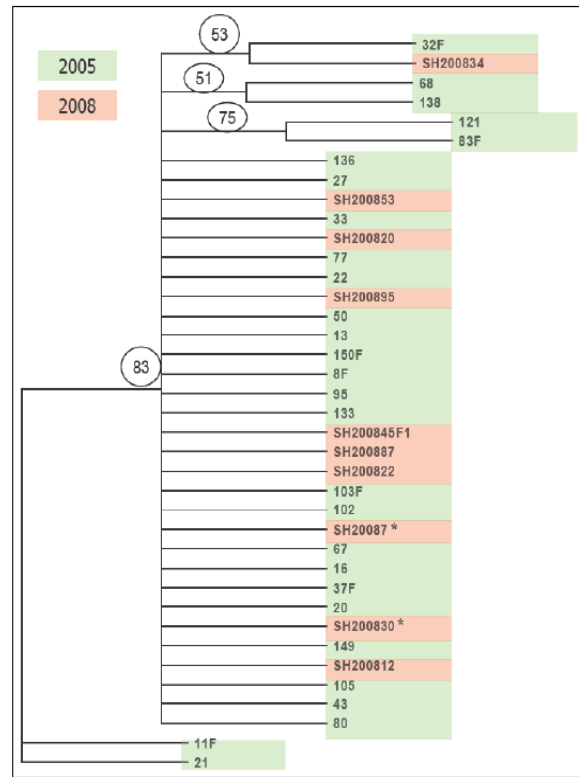


Fig. 3.14 D. *porB1b* Group 3



**Fig. 3.14 Temporal strain distribution of *N. gonorrhoeae* in Shanghai based on *porB* DNA sequences: 2005/2008**

**C. Group 2 *porB1b* sequences, D. Group 3 *porB1b* sequences.**

Phylogenetic analysis was conducted using the PAUP program. Tree was figured and presented in Treeview. Branch lengths are shown proportional to the amount of change along the branches. The scale distance bar indicates the number of nucleotide substitutions per site. Bootstrap values greater than 50% are shown in circles over the branches.

The SH2005 sequences are highlighted in blue and the SH2008 sequences highlighted in pink. Dashed arrows indicate the sequence contained highest number of isolates for *porB1a* isolates (a) and *porB1b* isolates (b-d).

Stars on the SH2008 sequences indicate that those sequences were also present in the SH2005 isolates. The SH2008 sequences without a star indicate a novel sequence as compared to the SH2005 isolates.

### 3.3.1.5 Spatial Strain Distribution of *N. gonorrhoeae* Isolates: Shanghai/Urumchi

To determine geographic strain distribution, *porB* DNA sequences for the SH2008 and the UQ2008 isolates were combined into two datasets: SH2008/UQ2008 for *porB1a* and SH2008/UQ2008 for *porB1b*. Each dataset was subjected to phylogenetic analysis using the PAUP program.

The 6 *porB1a* sequences for the SH2008 isolates were distinct from the *porB1a* sequences observed in the UQ2008 isolates. Isolates of the two surveys were dispersed along the phylogenetic tree. Similarly, the *porB1b* sequences in the SH2008 and the UQ2008 isolates differed, and were dispersed along the phylogenetic tree as well. (**Fig. 3.15**).

Fig. 3.15 A. *porB1a*

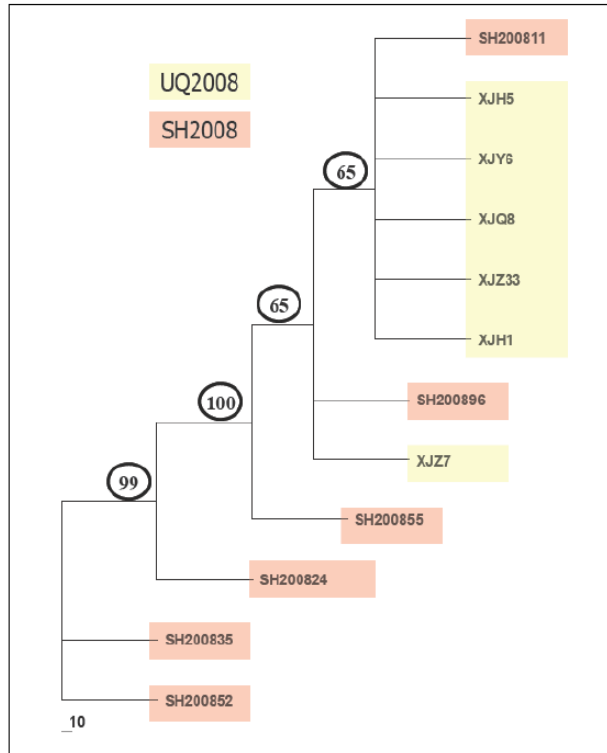
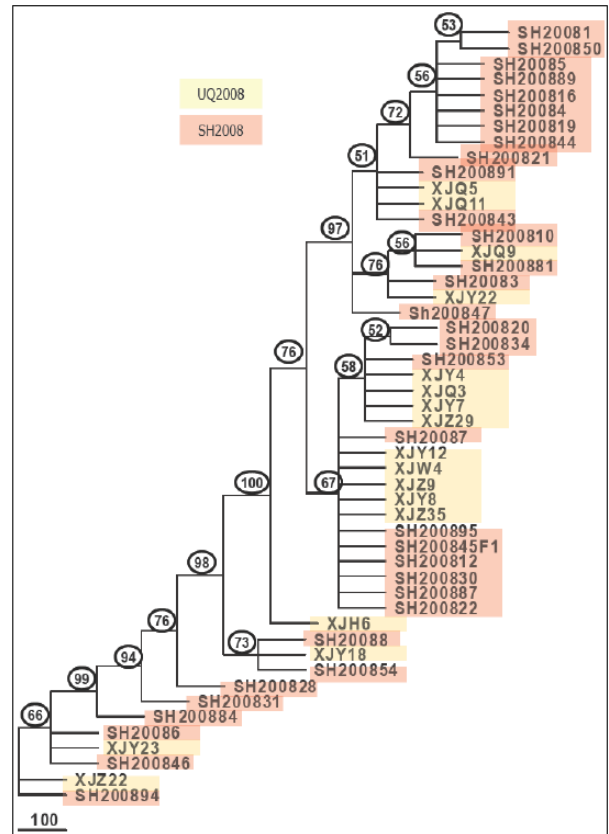


Fig. 3.15 B. *porB1b*



**Fig. 3.15 Spatial strain distribution of *N. gonorrhoeae* based on *porB* DNA sequences: Shanghai/Urumchi**

**A. *porB1a* sequences, B. *porB1b* sequences**

Phylogenetic analysis was conducted using the PAUP program. Tree was figured and presented in Treeview. Branch lengths are shown proportional to the amount of change along the branches. The scale distance bar indicates the number of nucleotide substitutions per site. Bootstrap values greater than 50% are shown in circles over the branches.

The SH2008 sequences are highlighted in pink, and the UQ2008 sequences are highlighted in yellow.



### **3.3.2 NG-MAST Analysis of *N. gonorrhoeae* Isolates**

#### **3.3.2.1 NG-MAST Analysis of the SH2005 *N. gonorrhoeae* Isolates (see Section 3.3.3)**

#### **3.3.2.1 NG-MAST Analysis of the SH2008 *N. gonorrhoeae* Isolates**

NG-MAST analysis was performed for the 81 isolates collected from Shanghai in 2008. The index of discrimination (ID) for the NG-MAST analysis was 98.1%. There were 50 NG-MAST sequence types (STs) among the 81 *N. gonorrhoeae* isolates; 27 of them (43 isolates) were new to the NG-MAST database. The largest cluster (ST# 1866) comprised 6 isolates (7.4%). One cluster (ST# 3288) comprised 4 isolates. Two clusters (ST# 3356 and 3361) each comprised 4 isolates. Five ST clusters each comprised 3 isolates, and six clusters each comprised 2 isolates. The remaining 35 STs each comprised a single isolate.

#### **3.3.2.2 NG-MAST Analysis of the UQ2008 *N. gonorrhoeae* Isolates**

NG-MAST analysis was performed for 44 *N. gonorrhoeae* isolates collected from Urumchi in 2007-2008. The ID for the NG-MAST analysis was 94.6%. There were 25 NG-MAST STs among the 44 *N. gonorrhoeae* isolates; 13 of them (15 isolates) were new to the NG-MAST database. The largest cluster (ST# 1866) comprised 8 isolates (18.2%). One cluster (ST# 436) comprised 6 isolates. Seven ST clusters each comprised 2 isolates. The remaining 16 STs each comprised a single isolate.

### 3.3.3 Comparison of the modified *porB*-based and NG-MAST Analysis for Differentiating *N. gonorrhoeae* Isolates

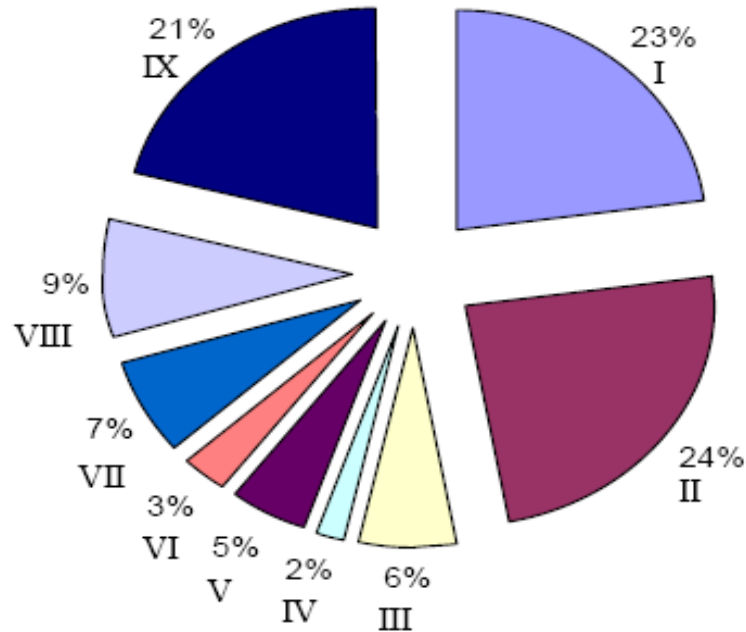
These results have been reported in J Clin Microbiol (Liao et al 2009). Permission for use has been obtained from the American Society for Microbiology (**Appendix A2.6**).

One hundred and ninety-nine *N. gonorrhoeae* isolates, consecutively collected from Shanghai in 2005, were analyzed using the NG-MAST typing method. Among these isolates, 157 were from male patients and 42 were from female partners with gonorrhea infections. These isolates comprised 40 sexual connections, including 39 dyads (one male index patient and one female partner) and 1 triad (one male with 2 female partners).

The index of discrimination (ID) of the NG-MAST analysis for the 199 isolates was 0.982. Among the 199 *N. gonorrhoeae* isolates, 114 NG-MAST STs were identified (i.e. 1.7 isolates per NG-MAST ST). Sixty-two percent of the 114 STs had not been previously reported. NG-MAST ST421 was the largest cluster among the isolates, containing 13.6% of the isolates (27/199). The second largest cluster of isolates (n=6) exhibited NG-MAST ST1691.

The ID of *porB*-based DNA sequence typing for the 199 isolates was 0.942. Among the 199 *N. gonorrhoeae* isolates, 81 *porB* sequence types (PSTs) were identified (2.5 isolates per PST).

The 199 isolates were divided into 9 groups (I-IX) based on the number of isolates with identical *porB* DNA sequences (**Fig. 3.16**). There were 46 isolates in Group I and each isolate exhibited a distinct *porB* sequence. Forty-eight isolates were classified in Group II, representing 24 *porB* sequences (each *porB* sequence comprised 2 isolates). Twelve isolates in Group III exhibited 4 *porB* sequences, with each sequence containing 3 isolates. The 10 isolates in Group V displayed 2 *porB* sequences, each containing 5 isolates. *N. gonorrhoeae* isolates in Group IV (n=4), Group VI (n=6), Group VII (n=14), Group VIII (n=17), and Group IX (n=42) each exhibited a distinct *porB* sequence. Group IX isolates formed the largest cluster based on *porB* sequence analysis, accounting for 21.1% of the 199 isolates.



**Fig. 3.16** *porB*-based groups of 199 *N. gonorrhoeae* isolates (SH2005). *N. gonorrhoeae* isolates were grouped based on the number of isolates with identical *porB* DNA sequences. Group I: forty-six *porB* sequences each comprised a single isolate (n=46). Group II: twenty-four *porB* sequence each contained 2 isolates (n=48). Group III: four *porB* sequences each comprised 3 isolates (n=12). Group IV: 4 isolates have an identical *porB* DNA sequence. Group V: two *porB* sequences each comprised 5 isolates (n=10). Group VI: 6 isolates have an identical *porB* DNA sequence. Group VII: 14 isolates have an identical *porB* DNA sequence (n=14). Group VIII: 17 isolates have an identical *porB* DNA sequence. Group IX: 42 isolates have an identical *porB* DNA sequence. Percentages represent the proportion of total isolates.

Clusters of *N. gonorrhoeae* isolates identified by the *porB*-based analysis and NG-MAST typing were compared (**Table 3.12**). Each isolate in Group I (n=46) with a distinct *porB* sequence type (PST) also exhibited a distinct NG-MAST ST. Twenty-one of the 24 PSTs in Group II had identical NG-MAST STs, while the remaining PSTs each displayed a different ST (i.e. 6 STs). Isolates in Group III (n=12) with 4 PSTs were further differentiated into 8 NG-MAST STs, with 3 of the PSTs further differentiated by NG-MAST. Group V isolates (n=10) with 2 PSTs were differentiated into 8 STs with each PST cluster split into 4 NG-MAST STs. Isolates with a single PST in Group IV (n=4), Group VI (n=6), VII (n=14), VIII (n=17), or IX (n=42) were further differentiated into 2, 5, 6, 10, and 7 NG-MAST STs, respectively. A few isolates with identical NG-MAST STs were further differentiated by *porB* DNA sequence analysis. For example, NG-MAST ST#567 (2 isolates), ST#641 (4 isolates), ST#1691 (6 isolates), and ST#2066 (3 isolates) were each differentiated into 2 *porB* PSTs.

Thirty *porB* PSTs and 36 NG-MAST STs were identified among 81 isolates which comprised 40 sexual contacts (39 dyads and 1 triad). Isolates of the triad and 37 dyads had identical *porB* PSTs (95.0%, 38/40) and 2 dyads exhibited different PSTs between the epidemiologically connected isolates. The concordance rate between NG-MAST analysis and epidemiological connections was 95.0% (38/40). As expected, the 2 dyads with different PSTs also had different NG-MAST STs.

### 3.3.4 Summary of the Modified *porB*-based Typing Scheme and the NG-MAST

The modified *porB*-based typing scheme and the NG-MAST method were used to differentiate *N. gonorrhoeae* isolates in 3 strain collections in China (**Table 3.13**). The indexes of discrimination were 0.932-0.968 and 0.946-0.982 for the modified *porB*-based scheme and the NG-MAST, respectively. Each *porB* sequence comprised 1.9 – 2.8 isolates whereas each NG-MAST ST comprised 1.6 – 1.8 isoaltes. The largest cluster of *N. gonorrhoeae* isolates identified by the *porB*-based analysis comprised 12.3 – 21 isolates, whereas the largest NG-MAST cluster comprised 7.4-18.2 isolates.

**Table 3.12 Distribution of *porB* DNA sequences and NG-MAST sequence types (STs) in 199 *N. gonorrhoeae* isolates from Shanghai in 2005**

Group	Number of isolates (%)	Number of <i>porB</i> sequences (PST)	Number of NG-MAST STs
I	46 (23%)	46	46
II	48 (24%)	24	26
III	12 (6%)	4	7
IV	4 (2%)	1	2
V	10 (5%)	2	8
VI	6 (3%)	1	5
VII	14 (7%)	1	6
VIII	17 (9%)	1	10
IX	42 (21%)	1	7
Total	199 (100%)	81	114*

\*: Some of the NG-MAST STs overlapped across the *porB* DNA sequence based groups.

PST: *porB*-based sequence type.

NG-MAST ST: sequence type (ST) of the *N. gonorrhoeae* multi-antigen sequence (NG-MAST).

**Table 3.13 Index of discrimination of the modified *porB*-based DNA sequence and NG-MAST analysis for differentiating *N. gonorrhoeae* isolates**

City/Year	# of isolates tested	ID (%) <sup>§</sup>		# of types		# of isolates per type		% of isolates for the largest cluster	
		NG-MAST	<i>porB</i>	NG-MAST	<i>porB</i>	NG-MAST	<i>porB</i>	NG-MAST	<i>porB</i>
Shanghai/2005	199	98.2	94.2	115	81	1.7	2.5	13.6	21.0
Shanghai/2008	81	98.1	96.8	50	39	1.6	2.1	7.4	12.3
Urumchi/2007-2008	44	94.6	93.2	25	23	1.8	1.9	18.2	19.5

NG-MAST: *Neisseria gonorrhoeae* Multi-Antigen Sequence Typing

\*: Initially the 199 SH2005 isolates were tested for indexes of discrimination of *porB*-based analysis and NG-MAST.

§: ID- Simpson's index of discrimination.

NA: Not analyzed.

### 3.3.5 Concordance between Patient-reported Sexual Contacts and *porB* Genotypes

To determine the concordance between *N. gonorrhoeae porB* genotypes recovered from known sexual contacts, all isolates from patients having sexual contacts in Shanghai in 2005 were analyzed using the modified *porB*-based DNA typing method. The *N. gonorrhoeae* isolates included a total of 152 *N.* isolates (74 isolates from male index patients and 78 isolates from their female sex partners), which formed 74 sexual connections: 70 dyads (140 isolates) and 4 triads (12 isolates).

Twenty-nine isolates (19.1%, 29/152) had *porB1a* genotypes which comprised 7 *porB1a* sequences (**Fig. 3.17A**). Two large clusters with identical *porB1a* sequences were identified; one cluster comprised 10 isolates from 5 dyads, and the other comprised 9 isolates from 3 dyads and 1 triad. The remaining 5 *porB1a* sequences comprised 10 isolates (4 sequences each comprised a dyad, and 1 sequence comprised 2 isolates from two female partners).

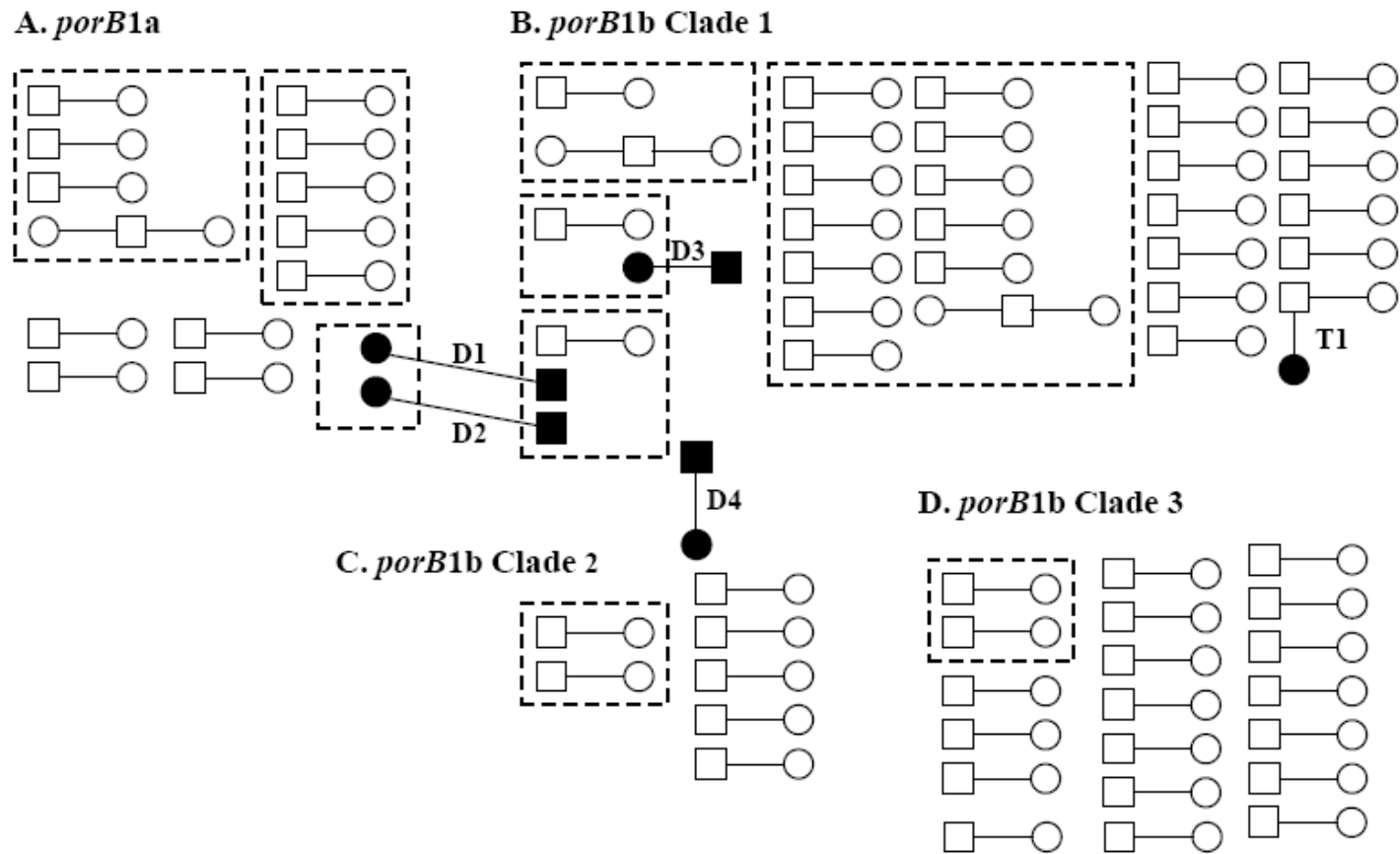
One hundred and twenty-three isolates (80.9%, 123/152) exhibited *porB1b* genotypes which comprised 46 sequences. The *porB1b* isolates were grouped into 3 clades based on phylogenetic trees generated using the Clustal W program. The *porB1b* Clade 1 comprised 68 isolates having 20 *porB* sequences (**Fig. 3.17B**). The *porB1b* Clade 2 comprised 15 isolates having 8 distinct sequences (**Fig. 3.17C**), whereas the *porB1b* Clade 3 had 40 isolates with 19 distinct sequences (**Fig. 3.17D**).

In total, 74 sexual connections were reported epidemiologically and these were linked by solid lines. Among them isolates from 69 sexual connections had identical *porB* sequences and the concordance rate was 93.2% (69/74). The incongruent relationships (**Fig. 3.17**, black squares or black circles) included 4 dyads (D1-D4) and 1 triad (T1). In 2 dyads (D1, D2), the isolates from female partners had *porB1a* sequences while the isolates from the corresponding male index patients exhibited *porB1b* sequences. Two isolates in one dyad (D3) had different *porB1b* sequences but they belonged to the same *porB1b* clade; and another incongruent dyad (D4) had different *porB* sequences in different clades. In the triad (T1), the isolate from one female partner

had a unique *porB* sequence, while the *porB* sequences of the other two (male index and female partner) were identical.

Large clusters having identical *porB* sequences and comprising multiple sexual connections were identified for both *porB1a* and *porB1b* isolates. For example, two clusters were identified in *porB1a* isolates, comprising 4 (9 isolates) and 5 (10 isolates) sexual contacts, respectively (**Fig. 3.17A**). The largest cluster comprised 13 sexual relationships (27 isolates) (**Fig. 3.17B**); clusters with 2 or 3 sexual contacts were also observed for the *porB1b* isolates (**Fig. 3.17B-D**).





**Fig. 3.17 Sexual networks identified by *proB* typing.** *porB1a* and *porB1b* genotypes and clades were defined based on sequence alignments and phylogenetic trees generated by Cluastal W as described in Section 2.5 (Larkin et al 2007). Squares- male index patients. Circles- female sexual partners. Isolates having sexual contacts were linked with a solid line. Isolates having different sequences in sexual dyads or triads were shown in black squares (from males) or black circles (from females). All other sexual contacts had identical *porB* sequences. Isolates inside rectangles with dashed line had an identical *porB* sequence.

## **CHAPTER FOUR**

### **DISCUSSION**

## 4.1 Prevalence of Antimicrobial Resistance in *Neisseria gonorrhoeae*

### 4.1.1 Prevalence of Reduced Susceptibility to Third-generation Cephalosporins in *N. gonorrhoeae* Isolates

The global spread of *N. gonorrhoeae* isolates resistant to different classes of antibiotics resulted in the removal of inexpensive antimicrobials such as penicillins, tetracyclines, macrolides and quinolones from gonorrhea treatment guidelines worldwide (Tapsall 2002, 2005, 2006, 2009; Workowski et al 2008). After the spread of quinolone resistant *N. gonorrhoeae* (QRNG) strains worldwide, third-generation cephalosporins have become the antibiotics of choice for the treatment of gonococcal infections (Wang & Zhang 2007; PHAC 2006; CDC 2006, 2007a).

Oral third-generation cephalosporins used for the treatment of gonorrhea included cefixime (400 mg single dose), recommended by the WHO, Canada, the United States and the United Kingdom (WHO 2003; PHAC 2006; BASHH 2005; CDC 2006), cefitibuten in Hong Kong and cefditoren and cefdinir in Japan before 2006 (Lo et al 2010; Jap Soc STD 2006). Among the parental cephalosporins, ceftriaxone is the recommended first line antimicrobial for the treatment of gonorrhea in the United States (CDC 2007a; CDC2006), Canada (PHAC 2006), the United Kingdom (BASHH 2005), China (Wang & Zhang 2007), Japan (Yakoi et al 2007; Jap Soc STD 2006) and is recommended by the WHO (WHO 2003). The dose of ceftriaxone is the subject of debate with 125 mg recommended in the United States and by the WHO (Newman et al 2007; WHO 2003). Many countries recommended a dose of 250 mg (Barry & Klausner 2009). In Japan and China, a single dose of 1000 mg is recommended (Wang & Zhang 2007; Yakoi 2007).

Results from my research, for the first time, indicated that *N. gonorrhoeae* isolates with reduced susceptibility to ceftriaxone are highly prevalent in Shanghai, the social economic centre of China. In 2005 in Shanghai, 11.9% (19/159) of *N. gonorrhoeae* isolates exhibited reduced susceptibility to ceftriaxone (MICs = 0.125 - 0.25 mg/L), and this rate increased to 19.7% (14/71) in 2008. In Urumchi 2007, there was also a small percentage of isolates (4.5%, 2/44) that

exhibited reduced susceptibility to ceftriaxone (MIC = 0.125 mg/L). Isolates with elevated ceftriaxone MICs during the 1990s have been reported in China; however, these results were not confirmed at the national reference laboratory and MIC values were not specified (Ye et al 2002, 2004).

Recent reports have also demonstrated that gonococci with reduced susceptibility to third-generation cephalosporins are emerging and spreading globally (Ito et al 2004; Martin et al 2006; WHO-WPR 2006; Tapsall et al 2009; Barry & Clausner 2009). In Australia, *N. gonorrhoeae* isolates with reduced susceptibility to ceftriaxone (MICs = 0.05-0.5 mg/L) was present in 2001 which and were possibly imported by international travelers and their sex partners (Tapsall et al 2008). Sporadic isolates with ceftriaxone MIC  $\geq$  0.5 mg/L have been observed in Vietnam (Cao et al 2008), the Philippines and Thailand (Clendennen et al 1992a/b), though further testing from a reference laboratory were not performed. In India, Bala et al recently reported 9 isolates with ceftriazone MICs = 0.064 – 0.094 mg/L among 382 isolates collected in New Delhi during 2002-2006 (Bala et al 2007).

Recently, the European Surveillance of Sexually Transmitted Infections (ESSTI) has identified isolates with ceftriaxone MICs of  $\geq$  0.125 mg/L (Martin et al 2006; Cole et al 2010). Other reports from national surveillance programs in Europe such as the UK (HPA 2008), Spain (Vazquez et al 2007), Italy (Martin et al 2006), Sweden (Olsen et al 2008), and Greece (Tzelepi et al 2008) have also documented isolates with increased ceftriaxone or cefixime MICs. The decreased susceptibility to cefixime (MIC  $\geq$  0.25 mg/L) first observed in gonococcal isolates in 2007 (0.2%) continued to increase, reaching 1.5% in 2008 in UK (HPA 2009).

In the United States, a few isolates with increased ceftriaxone MICs were reported since 1986 when the National Gonococcal Isolate Surveillance Program (GISP) was established (CDC 2008b). In 2001, three isolates were identified in Hawaii with multidrug resistance and having cefixime MIC of 0.25-0.5 mg/L and ceftriaxone MIC of 0.125 mg/L (Wang et al 2003).

A recent report from Canada (Allen et al 2011) observed that 9.4% of 149 isolates in Ontario had reduced susceptibility to cefixime (MICs = 0.125 – 0.25 mg/L), or ceftriaxone (MICs = 0.032 – 0.125 mg/L) though all isolates (up to 2006) examined by the Public Health Agency of Canada were susceptible to ceftriaxone (PHAC 2008a).

Limited data from Africa have not reported isolates with cefixime MICs of 0.25 - 0.5 mg/L and ceftriaxone MIC of 0.125 mg/L (Barry & Klausner 2009).

Recently, a few isolates with ceftriaxone MIC of > 0.25 mg/L were reported in Brazil in 2007, although confirmation of reference laboratory testing is needed (Dillon et al, unpublished data).

Treatment failures with third-generation cephalosporins have primarily reported with use of oral cephalosporins (Barry & Klausner 2009). In 2000, treatment failures with the oral cephalosporins cefpodoxime and cefdinir were reported in Japan (Akasaka et al 2001). Subsequent reports from various regions in Japan documented the rapid spread and increase of resistance to oral third-generation cephalosporins (Tanaka et al 2002, 2006; Ito et al 2004; Takahata et al 2006; Ameyama et al 2002). Beginning in 2006, cefixime was no longer recommended as first line therapy for gonorrhea in Japan (Yakoi et al 2007). Treatment failures were also reported in Hong Kong (Lo et al 2008). Among 1228 gonorrhea cases during 2006-2007 in Hong Kong, 3.7% (42 cases) were with ceftibuten treatment failure (400mg single dose) (Lo et al 2008).

Treatment failure coupled with reduced susceptibility to third-generation cephalosporins indicates that the current recommendations for the treatment of gonorrhea need to be reviewed and that on-going surveillance is highly warranted.

Breakpoints for susceptibility to ceftriaxone in *N. gonorrhoeae* have not been well defined. The term “reduced susceptibility” is commonly used. The Clinical and Laboratory Standards Institute (CLSI 2006, 2009) defines ceftriaxone MICs >0.25 mg/L as having reduced

susceptibility, whereas the European Committee on Antimicrobial Susceptibility Testing (EUCAST) defines ceftriaxone MICs  $> 0.125$  mg/L as having decreased susceptibility (Cole et al 2010). In previous studies of susceptibility to ceftriaxone in *N. gonorrhoeae* clinical isolates, a variety of definitions for reduced (decreased) susceptibility have been used [e.g. 0.016-0.06 mg/L (Whiley et al 2010),  $\geq 0.12$  mg/L (Lee et al 2010), 0.016-0.25 mg/L (Whiley et al 2007a),  $\geq 0.125$  mg/L (Ito et al 2005), 0.064-0.125 mg/L (Lindberg et al 2007), and 0.032 – 0.125 mg/L (Allen et al 2011)]. Given the above history, in my research, I defined isolates having ceftriaxone MICs of 0.125-0.25 mg/L as “reduced susceptibility to ceftriaxone” which will be helpful comparing my results with other reports.

#### **4.1.2 Susceptibility of *N. gonorrhoeae* Isolates to Spectinomycin**

We did not observe spectinomycin resistant isolates (MICs  $\geq 128.0$  mg/L; CLSI 2006, 2009) in Shanghai and Urumchi. However, isolates with intermediate levels of susceptibility (MIC = 64.0 mg/L; CLSI 2006, 2009) were observed in Shanghai and the percentage of intermediate susceptible isolates increased from 1.9% (3/159) in 2005 to 9.9% (7/71) in 2008. Spectinomycin is being used as an alternative regimen for the treatment of uncomplicated urogenital gonorrhea in China (Wang & Zhang 2007), therefore, close monitoring of trends of susceptibility in *N. gonorrhoeae* to this antibiotic is warranted.

In the mid-1980s, clinical treatment failures caused by spectinomycin-resistant strains began to be present in US military personnel in the Republic of Korea (Boslego et al 1987). Gonococcal resistance to spectinomycin has also been reported from the Western Pacific regions (WHO-WPR 2001) and from the Latin American countries (Dillon et al 2006). No resistant isolates have been identified in Europe according to published reports (WHO 2001; Olsen et al 2008; Cole et al 2010; Starnino et al 2008).

Resistance to spectinomycin has been rare in the United States, with a reported resistant rate of  $< 1\%$  (CDC 2005; Newman et al 2007). In Canada, it was reported that one PPNG isolate was

also resistant to spectinomycin (Dillon 1981, 1989; Dillon et al 1978). Since 1990s, spectinomycin-resistant isolates have not been reported in Canada (PHAC2008a).

In a landmark report with regards to the antimicrobial susceptibility of *N. gonorrhoeae* isolates in Latin America and the Caribbean (LAC), sporadic spectinomycin-resistant isolates were identified in the LAC region during the 1990s (Dillon et al 2006). Unfortunately data on trends of spectinomycin susceptibility were limited after 2000 in the LAC region.

Spectinomycin is an alternative regimen for treating urogenital gonorrhea patients who do not tolerate cephalosporins. However, spectinomycin has limited effectiveness for the treatment of pharyngeal infection, and it is not currently commercially available for gonococcal treatment in the United States (CDC 2006). Cautions of wide use of spectinomycin were executed because high levels of resistance developed when this antimicrobial was widely used in the mid-1980s (Boslego et al 1987).

#### **4.1.3 *N. gonorrhoeae* Isolates Are Resistant to Quinolones**

Ciprofloxacin, a fluoroquinolone antibiotic, had been recommended for the treatment of gonorrhea in China in 1990s and early 2000s. Almost all isolates examined in our study (97.7% - 100%) were resistant to ciprofloxacin (MICs  $\geq$  1.0 mg/L). Furthermore, percentages of high levels of ciprofloxacin resistance (MICs  $\geq$  8.0 mg/L) increased over time from 55.9% in 2005 to 76.4% in 2008 in Shanghai. High percentages of ciprofloxacin resistance *N. gonorrhoeae* had been observed since it was introduced for gonorrhea treatment in early 1990s (Ye et al 2002; 15.5% in 1993 to 55.8% in 1998). In spite of the high prevalence of resistant isolates, ciprofloxacin continued to be a recommended antimicrobial for the treatment of gonorrhea in China until 2007 (Wang & Zhang 2007). It is imperative to promptly review and modify treatment guidelines based on scientific information.

A similar trend of the high prevalence of quinolone resistance has being noted in other parts of the world. In the Western Pacific Region, quinolone non-susceptible isolates (including

resistant and intermediate) were in excess of 90% of all isolates examined in Hong Kong, Mongolia, India, Thailand and Sri Lanka, and between 75% and 90% of all isolates tested in Brunei, Japan, Korea, Malaysia, Singapore and Vietnam (WHO-WPR 2008, 2010). Percentages of quinolone-resistant isolates in Japan increased from 6.6% in 1993-1994 to 24.4% in 1997-1998 (Tanaka et al 2000a), further to 27.5% in 1999-2000 and 78.3% in 2002 and 78.1% in 2007 (Ito et al 2004; WHO-WPR 2010).

A recent report from the ESSTI (Cole et al 2010) revealed that the overall level of ciprofloxacin resistance was high in many European countries (42% to 51% for 2006 - 2008), and that all countries displayed more than 5% resistance rates each year. In Italy, the resistance percentage of *N. gonorrhoeae* isolates was 34.2% in 2003-2005 (Starnino et al 2010). In the UK, ciprofloxacin resistance is prevalent in England and Wales, having risen steadily since 2000 and apparently stabilising at 28% in 2008. The burden of ciprofloxacin resistance remains disproportionately high in MSM, increasing from 11% in 2003 to 46% in 2008 (HPA 2009).

Based on data from Gonococcal Isolate Susceptibility Project (GISP) in the United States, the emergence of quinolone-resistant *N. gonorrhoeae* was first identified in Hawaii in 1991. Resistant percentages of *N. gonorrhoeae* isolates to ciprofloxacin exceed 5% in many areas of the USA, and over 27% of isolates from patients with male-to-male sex are ciprofloxacin-resistant (Newman et al 2007).

In Canada, the proportion of ciprofloxacin resistance in *N. gonorrhoeae* isolates has increased from less than 1% in the early 1990s, to 2.4% in 2003, 6.2% in 2004, 15.7% in 2005, 28.8% in 2006 and 30% in 2007 (PHAC; <http://www.phac-aspc.gc.ca/std-mts/report/sti-its2008/04-eng.php#Fig9>, accessed on February 27, 2011). Separate reports showed similar trends in gonococcal ciprofloxacin resistance in Alberta (1.5% in 2001 to 27.7% in 2007; Plitt et al 2009) and Ontario (4% in 2002 to 27.8% in 2006; Ota et al 2009). Thus, quinolones are no longer recommended for the treatment of gonorrhoea in Canada (PHAC 2006).



In Africa, most studies for isolates before 2000 showed that *N. gonorrhoeae* remained susceptible to the fluoroquinolones (Dan 2004; WHO 2001). However, recent studies have shown that quinolone resistant *N. gonorrhoeae* have emerged and spread in Africa. For example, the prevalence of ciprofloxacin resistance was 7% in Cape Town in 2004 and 11% in Johannesburg, whereas in 2007, percentages of resistance isolates were 27% in Cape Town isolates and 32% Johannesburg (Lewis et al 2008), respectively.

Gonococcal quinolone resistance in Latin America and the Caribbean (LAC) was rare in 1990s although low level resistance were noted in several regions of the LAC (Dillon et al 2006; Dillon et al 2001b; Ison et al 1998; Dillon et al 1997, Swanston et al 1997), which may reflect the more limited use of these drugs in the region (Dillon & Pagotto 1999; Dillon et al 2001a/b). In 2009, resistant percentages ranged from 22% to 90% in most countries participating in the Gonococcal Susceptibility Surveillance Program in Latin America and the Caribbean (Dillon et al, unpublished data).

#### **4.1.4 *N. gonorrhoeae* Isolates Are Persistently Resistant to Penicillin and Tetracycline**

The overall burden of *N. gonorrhoeae* resistance to penicillin (MIC  $\geq$  2.0 mg/L) was 93.1% (Shanghai 2005), 88.7% (Shanghai 2008) and 79.5% (Urumchi 2008), respectively. Resistance percentages to tetracycline (MIC  $\geq$  2.0 mg/L) were 56.5% (Shanghai 2005), 64.5% (Shanghai 2008) and 61.4% (Urumchi 2008), respectively. These findings indicate that the prevalence of *N. gonorrhoeae* resistance to penicillin or tetracycline is persistently at very high levels in China, reflecting that gonococcal resistance to penicillin and tetracycline is long established in the world. Penicillin is no longer recommended for the treatment of gonorrhea and tetracycline is used for treating *Chlamydia trachomatis* co-infections in gonorrhea patients, together with macrolides (erythromycin or azithromycin).

##### **4.1.4.1 Penicillin Resistance in the World**

From 2000 through 2007 in China, penicillin-resistant isolates, defined as having MICs  $\geq$  1.0 mg/L (WHO-WPR 2001), accounted for 80% - 93% of isolates examined (WHO-WPR 2001,

2002, 2003, 2005, 2006a/b, 2008, 2010). In the 1990s (between 1993 and 1998), 66.7% of isolates tested were resistant to penicillin (Ye et al 2002). The high prevalence of penicillin-resistant gonococcal isolates remains a major problem in many parts of the Western Pacific countries/regions (WHO-WPR 2010). The proportion of isolates with penicillin resistance in 2007 was 38.3% (Australia), 64.3% (Brunei), 17.5% (Japan), 55.4% (Korea), 61.0% (Malaysia), 21.6% (New Zealand), 89.9% (the Philippines), 56.3% (Singapore), 37.2% (Vietnam) and 47.2% (India). In Japan from 1993 through 2002, the proportion of isolates with penicillin resistance (MIC  $\geq$  2.0 mg/L) ranged from 13.5% to 29.9% in 2002 (Tanaka et al 2004).

A recent report from the European Gonococcal Antimicrobial Surveillance Programme of the European Surveillance of Sexually Transmitted Infections (Euro-GASP of ESSTI) demonstrated an overall burden of 21% penicillin resistance during 2006 and 2008 (Cole et al 2010). The percentage of penicillin resistant isolates (2003-2005) in Italy was 25.5% (Starnino et al 2010).

In Latin America and the Caribbean (LAC) in the 1990s, percentages of penicillin-resistant isolates (MIC  $\geq$  2.0 mg/L) varied between 48.5% in 1993 and 25.3% of isolates tested in 1999 (Dillon et al 2006). In 2009, the percentage of isolates resistant to penicillin ranged from 8% to 90% (Dillon et al, unpublished data).

In the USA, the Gonococcal Isolate Surveillance Project (GISP) reported that (CDC 2004, 2007 GISP reports), approximately 10% of *N. gonorrhoeae* isolates were resistant to penicillin since the late 80s.

In Canada, the percentage of penicillin resistant *N. gonorrhoeae* isolates rose from 8.7% in 1992 to 15% to 22% in 2003 (Dillon 1992; Ng et al 2003). The penicillin resistance percentage for *N. gonorrhoeae* isolates nationwide in 2006 was 17% (PHAC 2008, <http://www.phac-aspc.gc.ca/publicat/2008/sti-its/gonorrhe-eng.php>, accessed on February 27, 2011).

#### **4.1.4.2 Tetracycline Resistance in the World**

The total burden of tetracycline resistance ( $\text{MIC} \geq 2.0 \text{ mg/L}$ ) in Shanghai was 56.5% (2005) 64.8% (2008) and 61.4% in Urumchi (2007-2008). The majority of tetracycline resistant *N. gonorrhoeae* isolates had high level resistance (i.e. TRNG). In the 1990s (between 1993 and 1998), 92.0% isolates tested were resistant to tetracycline ( $\text{MIC} \geq 1.0\%$ ) (Ye et al 2002). The higher prevalence in 1990s could be explained by the interpretation criteria which was lower than that used in my study.

In China, since 2000, only TRNG is reported to the national center of the gonococcal antimicrobial susceptibility program in Nanjing. Most antimicrobial susceptibility surveillance programs only reported TRNG as well. Some individual studies suggested that the prevalence of tetracycline resistance is high in many areas of the world (Cole et al 2010, WHO 2001, Starnino et al 2008).

Studies in Latin America and the Caribbean (LAC) in the 1990s reported that the total burden of tetracycline-resistance ( $\text{MIC} \geq 2.0 \text{ mg/L}$ ) in the region ranged from 28.6% (1994) to 52.5% (1993) of isolates tested, with an average percentage of tetracycline-resistant isolates of 43.4% over the decade (Dillon et al 2006; Dillon et al 2001b; Sosa et al 2003). In 2009, the percentage of isolates resistant to tetracycline ranged from 24% to 100% (Dillon et al, unpublished data).

Twenty-nine percent of isolates tested in 2006 in Canada were resistant to tetracycline (PHAC 2008, <http://www.phac-aspc.gc.ca/publicat/2008/sti-its/gonorrhe-eng.php>, accessed on February 27, 2011).

In the USA, the Gonococcal Isolate Surveillance Project (GISP) reported that approximately 10% of *N. gonorrhoeae* isolates were resistant to tetracycline since the late 80s (CDC 2007).

#### **4.1.5 Plasmid-mediated Antimicrobial Resistance in *N. gonorrhoeae***

#### 4.1.5.1 Prevalence of Plasmid-mediated Resistance in *N. gonorrhoeae*

The emergence of high-level, plasmid-mediated resistance to penicillin (PPNG) were first reported in 1976 (Percival et al 1976; CDC 1976) and to tetracycline (TRNG) in mid-1980s (CDC 1985; Roberts et al 1988).

Approximately 50% of the isolates tested in this study were PPNG, TRNG or PP/TRNG. Noticeably, TRNG including PP/TRNG significantly increased in Shanghai, from 20.1% for 2005 to 56.3% for 2008. In China between 1993 and 1998, PPNG or TRNG accounted for 48.8% and 34.2% of the isolates tested, respectively (Ye et al 2004). In Nanjing China, the rate of PPNG rose from 8.0% to 57.36% in 2004, and declined to 44.44% in 2006, and the prevalence of TRNG increased from 1.8% in 1999 to 32.82% in 2006 (Su et al 2007). In many other parts of the Western Pacific regions, PPNG and TRNG has also been high for many years and ranged between 35% and 55% (WHO 2001, WHO-WPR 2006, 2010). In a recent report in India, the rates of PPNG, TRNG and PP/TRNG were 16.5%, 8.9% and 4.7%, respectively (Bala et al 2008).

In the Latin American and the Caribbean region (LAC), high percentages of plasmid-mediated resistance to penicillin (i.e. PPNG) had been noted in 1990s, ranging from 17.9% to 38.8% (Moreno et al 1987; Dillon et al 2006). Between 1990 and 1998, PPNG represented more than 28% of all isolates tested, falling to 17.9% in 1999 (Dillon et al 2006). Percentages of TRNG were high in 1990s although they varied by year and by country, ranging from 1.4% to 89.5% (Dillon et al 2006). Recent survey demonstrated that percentages of plasmid-mediated resistance ranged from 10% to 62% for PPNG and 4% to 16% for TRNG among 10 countries in 2008 or 2009 (Dillon et al, unpublished data), showing a decreasing trend from 1990s.

The Gonococcal Resistance to Antimicrobials Surveillance Programme (GRASP) in UK reported that the combination of PPNG/TRNG remained relatively stable up until 2006, increasing from 2.1% in 2006 to 7.6% in 2008. High percentage of patients with PP/TRNG reported sex abroad in the past three months, indicating that PPNG/TRNG is likely to be imported in many cases (HPA 2008).

The number of PPNG strains isolated in Canada 1976-1984 comprised < 1% of all gonococcal isolates (Dillon et al 1986), it increased to 5% in 1985, 9.6% in 1990 (Yeung et al 1990; Dillon 1992; Yeung et al 1991). Between 1986 and 1997, 6,306 TRNG isolates were cultured and identified in Canadian laboratories, representing 29.1% of all *N. gonorrhoeae* isolates (Greco et al 2003). Combined plasmid-mediated resistance of PPNG and TRNG was common in Canada (Carballo et al 1990; Dillon and Carballo 1990).

#### **4.1.5.2 Types of gonococcal $\beta$ -lactamase-producing and *tetM*-containing plasmids**

Penicillinase-producing *N. gonorrhoeae* (PPNG) comprised plasmids encoding a TEM-1-type  $\beta$ -lactamase (Pagotto et al 2000; Dillon et al 1989; Yeung & Dillon 1988). Several types of related penicillinase-producing plasmids have been described, including the Asia, Africa, Toronto, Rio, Nîmes and New Zealand plasmids (Dillon et al 1989, 1999). The Asia, Africa and Toronto types have been associated with epidemic outbreaks (Dillon & Yeung 1989). During 1976-1984, out of the 501 analyzed PPNG isolates from Canada, 402 (80.2%) carried the Asia type  $\beta$ -lactamase plasmids, followed by 79 (15.8%) and 20 (4%) isolates with the Africa and Toronto type, respectively (Dillon et al 1986). In South Africa, the Toronto and Africa types were predominant (Fayemiwo et al 2010).

In my study, a majority (> 77%) of PPNG isolates in Shanghai carried Asia-type plasmids, whereas the Toronto-type and the Africa-type were also present. No other types were observed. The distribution of plasmid types was similar to that found in Canada in 1980s (Dillon et al 2006). However; only Asia type was observed in PPNG isolates collected in Nanjing China, a nearby city of Shanghai (Su et al 2007), indicating the geographic dynamics of resistant plasmids.

High-level tetracycline resistance in *N. gonorrhoeae* (TRNG) is the result of the acquisition of plasmids carrying the streptococcal *tetM* determinant (Morse et al 1986; Carballo et al 1994). *tetM*-containing plasmids in TRNG are differentiated into the American type and Dutch type (Ison et al 1993, Xia et al 1995; Greco et al 2003). Initially, the American type was described in

the UK and Africa and the Dutch type in Asia and South America (Gascoyne-Bini et al 1994). A higher prevalence of Dutch type plasmids (79.3%) in TRNG than the American type (20.7%) has been reported in Canada (Greco et al 2003). Of the 78 TRNG isolates collected in Scotland in 1990s, 55% were the Dutch type (Beattie et al 1999). In South Africa, the America type was 3-fold more frequent as compared with the Dutch type (Fayemiwo et al 2010).

In my results, TRNG isolates from Shanghai exhibited a Dutch-type plasmid. In Nanjing China, a nearby city of Shanghai, 99.23% (258 of 260) of TRNG isolates comprised the Dutch type plasmid (Su et al 2007). The Dutch type plasmid is the prevalent type in many areas of the world. The absence of the American type plasmid in *N. gonorrhoeae* isolates in my study could be due to the small number of isolates examined.

#### **4.1.6 Conclusion**

Antibiotic treatment is the hallmark of curing gonococcal infections and controlling the spread of gonorrhoea. According to the accepted definition of gonococcal treatment efficacy, a cure rate of over 95% is desired if an antibiotic be recommended for the treatment of gonorrhoea. Thus, an antibiotic should not be used in situations where resistance is observed in greater than 3% to 5% of gonococcal isolates tested.

My research provides longitudinal (2005 and 2008) and spatial (Shanghai and Urumchi) information on the antimicrobial resistance of *N. gonorrhoeae* in China. It is the first study showing a high prevalence of reduced susceptibility to ceftriaxone in China, a third-generation cephalosporin currently the first-line antimicrobials for the treatment of gonorrhoea in China and elsewhere. This study also demonstrates that *N. gonorrhoeae* is persistently resistant to ciprofloxacin, penicillin and tetracycline, antibiotics had been used for treating gonococcal infections in China and are no longer recommended. Spectinomycin is currently an alternative regimen for the treatment of gonorrhoea in China, and the increasing number of isolates with intermediate levels of susceptibility in Shanghai over time indicates the need of close monitoring on gonococcal antimicrobial susceptibility.

## 4.2 Molecular Mechanisms of Antimicrobial Resistance in *Neisseria gonorrhoeae*

Mechanisms of antibiotic resistance in *N. gonorrhoeae* have been genetically divided into two types, i.e. chromosomally mediated (CMR) and plasmid-mediated resistance (Dillon & Pagotto 1999). CMR mechanisms involve reduced access of antibiotic to the target sites and alteration of the target sites by mutations of various resistance determinants (Dillon & Pagotto 1999; Tapsall 2001). Multiple resistance determinants may coexist in a single isolate conferring additive resistance to a single or a number of different antibiotics (Tapsall 2001). Plasmid-mediated resistance in *N. gonorrhoeae* is conferred by  $\beta$ -lactamase-producing plasmids (i.e. penicillinase-producing *N. gonorrhoeae*, PPNG) or by *tetM*-containing plasmids (e.g. high levels of tetracycline resistance *N. gonorrhoeae*, TRNG) (Dillon & Pagotto 1999).

### 4.2.1 Mechanisms of Reduced Susceptibility to Ceftriaxone in *N. gonorrhoeae*

I studied a panel of ceftriaxone susceptible (CRO<sup>S</sup>, MIC=0.004-0.016 mg/L, n=32) and reduced susceptible (CRO<sup>Red</sup>, MIC=0.125–0.25 mg/L, n=28) *N. gonorrhoeae* isolates from Shanghai that were collected in 2005 and 2008. I performed sequencing and bioinformatic analysis to determine if mutations in certain genes or possession of a particular PorB type are associated with reduced susceptibility to ceftriaxone.

My results show that the *porB1b* allele (expressing PIB) is required but is insufficient for conferring reduced susceptibility to ceftriaxone in *N. gonorrhoeae* isolates. Approximately 40% of the CRO<sup>S</sup> isolates (13/32) also exhibited a *porB1b* genotype (expressing PIB), suggesting that other loci in *porB1b* isolates are involved in mediating increasing ceftriaxone MICs.

G120K/A121D double mutations in PIB (*porB1b*) have been associated with reduced susceptibility of *N. gonorrhoeae* isolates to ceftriaxone (Lindberg et al 2007). Tanaka et al (2006) reported that G120/A121 mutations were only found in the one ceftriaxone resistant strain (MIC = 0.5 mg/L), but not in the 4 ceftriaxone susceptible strains tested (MIC  $\leq$  0.004 mg/L). I did not

find this to be the case with the isolates studied from Shanghai. The G120/A121 mutations of PorB were not associated with increasing ceftriaxone MICs, supporting other reports (Takahata et al 2006).

The transpeptidase domain of gonococcal PBP2 (*penA*) was polymorphic and exhibited 15 mutation patterns, but the “mosaic” PBP2 (Pattern X), which was first associated with reduced susceptibility to oral cephalosporins (i.e. cefixime) (Ameyama et al 2002), was not present in the *N. gonorrhoeae* isolates of the present study. Six of the 15 mutation patterns in PBP2 identified in the present study are new. The most common mutation patterns for all isolates combined (n=60) were Patterns V, XXI and XXVII. By comparison, the most common mutation patterns in isolates from Sydney, Australia were Patterns XII, X and XIII (Whiley et al 2007a/b), whereas in Korea, Pattern XIII was most common (Lee et al 2010). Interestingly Patterns XIII and XVII/XVIII were only present in CRO<sup>Red</sup> isolates in both the study by Whiley et al (MIC=0.06–0.12 mg/L; 17.9% of 28 isolates) (Whiley et al 2007a/b) and in the present study (MIC=0.125–0.25 mg/L; 21.4% of 28 CRO<sup>Red</sup> isolates). These 2 patterns comprised combinations of A501V and P551S (Pattern XIII) or A501V and G542S (Pattern XVII/XVIII) mutations which have been associated with increased ceftriaxone MIC (Whiley et al 2010). I conclude that a combination of A501V/T and G542S or A501V/T and P551S/L mutations, and probably mutations at other codons in PBP2 are required for increasing ceftriaxone MICs. Genetic confirmation and structure/function analysis of these mutations are warranted.

Over 90% of both CRO<sup>Red</sup> and CRO<sup>S</sup> *N. gonorrhoeae* isolates I examined contained an “-A” deletion in the 13bp inverted repeat sequence of the *mtrR* promoter, indicating that such a deletion is not implicated in reduced susceptibility to ceftriaxone. However A39T/H105Y or G45D/H105Y double mutations in MtrR were only present in CRO<sup>Red</sup> isolates in my study. Mutation A39T or G45D, either singly or in combination, diminishes binding of the MtrR repressor to the *mtrC/D/E* promoter and thereby increases resistance to hydrophobic agents (Hagman et al 1995; Lucas et al 1997; Shafer et al 1995). The H105Y mutation might inhibit MtrR dimerization and subsequently further reduce MtrR DNA binding (Shafer et al 1995), or it could enhance binding of ceftriaxone to MtrR which could then serve as a sink for the antibiotic



(W.M Shafer, Department of Microbiology and Immunology, Emory University School of Medicine, Atlanta, GA, USA; personal communication). A single H105Y mutation was exclusively present in the CRO<sup>S</sup> isolates and the wild type MtrR (*N. gonorrhoeae* FA1090) was observed mainly in the CRO<sup>Red</sup> isolates in the present study. It is reasonable to further hypothesize that a single H105Y mutation may be a “gain-of-function” mutation, enhancing MtrR repression activity and that the enhanced activity of the H105Y MtrR is diminished when mutations A39T and or G45D occur. Again, follow-up studies for genetic confirmation and structure/function analyses of H105Y mutation in MtrR are warranted.

It has been reported that the L421P mutation in PBP1 is present in *N. gonorrhoeae* isolates which have reduced susceptibility or are susceptible to cefixime (Takahata et al 2006) as well as in isolates with reduced susceptibility to ceftriaxone (Lindberg et al 2007). The L421P mutation is also present in *N. gonorrhoeae* isolates with various penicillin MICs although it may play a role in resistance to penicillin (Shigemura et al 2005). The majority of both the CRO<sup>Red</sup> (100%) and the CRO<sup>S</sup> (97.0%) *N. gonorrhoeae* isolates in the present study carried a L421P mutation in PBP1 (P>0.05). Therefore, the L421P mutation in PBP1 is not associated with reduced susceptibility of *N. gonorrhoeae* to ceftriaxone in the present study.

Previous reports suggest that cephalosporin resistant *N. gonorrhoeae* may be clonal (Lo et al 2008; Ameyama et al 2002; Lindberg et al 2007). It has been reported that the ceftibuten resistant *N. gonorrhoeae* isolates (n=11) from Hong Kong shared identical NG-MAST types (Lo et al 2008). Most isolates with the mosaic PBP2 and cefixime MICs > 0.125 mg/L from Japan were closely related in pulse-field gel electrophoresis analysis (Ameyama et al 2002), indicating a close genetic identity among the isolates with reduced susceptibility to third-generation cephalosporins. The majority (11/18) of *N. gonorrhoeae* isolates from Sweden with reduced susceptibility to cephalosporins belonged to 2 NG-MAST types (e.g. ST326 and ST925; Lindberg et al 2007). However, others have reported that CRO<sup>Red</sup> isolates are not clonal (Whiley et al 2007a/b; Takahata et al 2006; Lee et al 2010). The results of my research too demonstrated that CRO<sup>Red</sup> isolates from Shanghai were non-clonal; 28 CRO<sup>Red</sup> isolates displayed 22 *porB*

sequence types and 24 NG-MAST STs, whereas the 32 CRO<sup>S</sup> isolates exhibited 26 *porB* sequences and 28 NG-MAST STs.

Therefore from my research, it can be concluded that *porB1b* alleles are more frequently associated with *N. gonorrhoeae* CRO<sup>Red</sup> isolates, that these strains more frequently have missense mutations in the DNA binding domain of MtrR, and that the CRO<sup>Red</sup> isolates do not have defining mutations in PBP1. Specific patterns in the transpeptidase domain of PBP2 which are associated with the CRO<sup>Red</sup> phenotype are identified in the present study. The mosaic PBP2 first characterized in isolates with reduced susceptibility to cefixime, Pattern X was not present in the Shanghai isolates. *porB*-based DNA sequence and NG-MAST analyses revealed that the CRO<sup>Red</sup> isolates are non-clonal. These findings have impact in gonorrhea control by providing scientific information for development and modification of treatment guidelines, since third-generation cephalosporins are the first-line antibiotics recommended for the treatment of gonorrhea in China (Wang & Zhang 2007) and other countries (PHAC 2007, 2008a/b; Sexual Health Society of Victoria 2008; CDC USA 2006, 2007a; HPA UK 2005; Jpn Soc STD 2006).

#### **4.2.2 Role of PorB in Chromosomal Resistance to Penicillin or Tetracycline in *N. gonorrhoeae***

PorB, a porin, allows the passage of small molecules, such as  $\beta$ -lactams and tetracyclines, through the outer membrane (Danielsson et al 1986; Scudamore et al 1979). There are two isoforms of PorB in *N. gonorrhoeae*, e.g. PIA and PIB (Gotschlich et al 1987; Unemo et al 2002). A PorB protein comprises 8 surface exposed-loop regions interspaced by conserved transmembrane domains (van der Lay et al 1991). The surface exposed-loop regions of PorB have a high frequency of amino acid variations (Ison et al 1988; Smith et al 1995).

The PIA phenotype is associated with higher susceptibility to  $\beta$ -lactams and tetracyclines (Olesky et al 2006; Liao et al 2008). Amino acid substitutions at Gly-120 and Ala-121 of loop 3 of PorB are associated with decreased susceptibility to  $\beta$ -lactams and tetracyclines (Olesky et al 2002), and recently, G120K/A121D mutations in PorB were found to be associated with

decreased susceptibility of *N. gonorrhoeae* isolates to penicillins or third-generation cephalosporins (Zhao et al 2009; Tanaka et al 2006; Tapsall 2009a/b).

#### **4.2.3 Mechanisms of Quinolone Resistance in *N. gonorrhoeae***

Quinolone resistance in *N. gonorrhoeae* is exclusively mediated by chromosomal mutations (Tapsall 2001), although plasmid-mediated quinolone resistance has been frequently reported in other microorganisms (Martínez-Martínez et al 2008).

##### **4.2.3.1 Quinolone Resistance Determinant Regions (QRDRs)**

The subunits of DNA gyrase (GyrA) and topoisomerase IV (ParC) which are encoded by *gyrA* and *parC* respectively, are the targets for quinolones (Blondeau 2004). In *N. gonorrhoeae*, GyrA is the primary target and ParC is the secondary target (Belland et al 1994). Specific regions in GyrA and ParC have been defined as the quinolone resistant determinant regions (QRDRs) of *N. gonorrhoeae*. Mutations in QRDRs cause *N. gonorrhoeae* isolates resistant to quinolones such as fluoroquinolone resistance (CIP<sup>R</sup>; Belland et al 1994; Deguchi et al 1996).

The present research demonstrates that amino acid (AA) substitutions at codons Ser-91 and Asp-95 of GyrA determine quinolone resistance phenotypes of *N. gonorrhoeae*, consistent with reports from others (Trees et al 1999; Ng et al 2002a; Su et al 2001; Tanaka et al 2001). Other AA substitutions in GyrA reported in the present study and by others include AA mutations at codons Ala-67, Ala-75, Ala-84, His-88, Ala-92, Gln-102, Asn-103 and Val-120 (Trees et al 1999; Yang et al 2006; Giles et al 2004; Tanaka et al 2000b). The most frequent mutations in gonococcal ParC occur at residue Asp-86 or Ser-87, as observed in the present study and by others. Other ParC mutations at residues Ala-29, Gly-85, Ser-88, Glu-91, Ala-92, Phe-100 and Arg-116 have been observed (Trees et al 1999; Yang et al 2006; Giles et al 2004; Tanaka et al 2000b).

The combinations of the AA substitutions in GyrA and ParC of gonococcal QRDRs form diverse mutation patterns (Su et al 2001; Tanaka et al 1998). For example, nine mutation patterns were found in 66 ciprofloxacin resistant (CIP<sup>R</sup>) isolates in the USA (Trees et al 1999), and 17 mutation patterns were found in the 99 CIP<sup>R</sup> isolates from Shanghai, China in the present research. The majority of the QRDR mutation patterns have a double mutation in GyrA (e.g. Ser91-to-Phe and Asp95-to-Ala/Gly), which is frequently combined with a single mutation (e.g. Ser87-to-Arg/Asn) in ParC (Yang et al 2006; Trees et al 1999).

In my research, the association between mutations in ParC QRDR and gonococcal quinolone MICs was quantitatively analyzed. My results revealed that the presence of mutations in gonococcal ParC is correlated with higher ciprofloxacin MICs, suggesting that ParC mutations play a role in high level resistance to quinolones in *N. gonorrhoeae* isolates. In the present study GyrA mutations were present in all ciprofloxacin resistant but not in the only ciprofloxacin susceptible isolate, supporting the hypothesis that GyrA mutations are essential for a quinolone resistance phenotype in *N. gonorrhoeae* (Trees et al 1999). Thus, my research supports the hypothesis that GyrA mutations determine whether a gonococcal isolate is resistant to quinolones, while mutations in ParC are correlated with high-level quinolone resistance (Tanaka et al 1998).

#### **4.2.3.2 Trends of QRDR Mutation Patterns in Shanghai: 2005/2008**

Quinolones (i.e. fluoroquinolone) had been the antibiotic of choice for the treatment of gonorrhoeae during the early 1990s and the mid-2000s in China and other part of the world (Workoski et al 2008). The long history and intensive use of quinolones contributed to a significant selection pressure with the potential to cause high mutation rates in QRDRs of *N. gonorrhoeae* and subsequently resulting in the development and spread of resistant clones to quinolones. Previous studies reported that QRDR mutations are diverse among *N. gonorrhoeae* isolates from various locales and over time; however, predominate QRDR mutation patterns consistently contained GyrA mutations at codons S91 and D95 and ParC mutations at codon S87 (Yang et al 2006; Giles et al 2004; Su & Lind 2001; Yoo et al 2004; Ng et al 2002a; Trees et al 1999, 2001).

In the present study, for the first time, the QRDR mutation patterns in the post-quinolone era were compared to those when quinolones were commonly used for the treatment of gonorrhoea. We observed that the predominant QRDR mutation patterns remain although new codon mutations and mutation patterns were observed in 2008 as compared to 2005. Moreover, the percentages of CIP<sup>R</sup> were similar between 2005 and 2008; and more 2008 isolates (74.6%) had high ciprofloxacin MICs ( $\geq 8$  mg/L) than the 2005 isolates (45.9%). This finding suggests that quinolone resistant *N. gonorrhoeae* (QRNG) is stable both phenotypically and genetically. QRNG may last a long time even though selection pressure has been removed (Wang & Zhang 2007). The QRNG persistency may also be due to the continual wide use of quinolone drugs for the treatment of other infectious diseases in Shanghai and in China. Continuing observation of QRNG and surveillance of quinolone use in the overall communities is warranted.

#### 4.2.4 Conclusion

My research systemically examined mutations in various loci in association with gonococcal resistance to different antibiotics. It is the first report with regards to molecular mechanisms of reduced susceptibility to third-generation cephalosporins in *N. gonorrhoeae* isolates from China. Our results revealed that the molecular factors associated with reduced susceptibility to ceftriaxone include a *porB1b* (expressing PIB) genotype, a wild-type MtrR protein or double mutations in MtrR, and certain mutation combinations in PBP2. The present study demonstrated, for the first time, that molecular determinants of quinolone resistant *N. gonorrhoeae* are stable genetically and could remain for a long time in the post-quinolone era.

### 4.3 Molecular Epidemiology of *N. gonorrhoeae* in China

#### 4.3.1 *porB*-based DNA Sequence Analysis is a Useful Tool for Molecular Epidemiological Studies in *N. gonorrhoeae*

Molecular typing methods should possess the characteristics of typeability (able to type all strains), reproducibility of results, ease of use, ease of interpretation and high discriminatory powers (Maslow et al 1993; Unemo & Dillon 2011).

DNA sequence analyses of appropriately selected gene(s) are currently the methods of choice for distinguishing *N. gonorrhoeae* isolates as it provides unambiguous and reproducible information, high discriminatory powers. DNA sequence data can be stored or shared electronically, permitting reliable comparisons to be made between laboratories (Maiden 2006; O'Rourke et al 1995; Viscidi et al 2000). Among them, NG-MAST and *porB*-based analyses have been widely applied in molecular epidemiological studies in *N. gonorrhoeae* (Unemo & Dillon 2011). NG-MAST utilizes internal fragments of two variable genes, *porB* and *tbpB*, to achieve high discriminatory abilities. The *porB*-based typing schemes use either the entire *porB* gene or a fragment of the *porB* gene (Viscidi et al 2000; Unemo et al 2002, 2003; Liao et al 2008). Furthermore, *porB* DNA sequences are associated with two gonococcal *porB* isoforms (i.e. *porB1a* and *porB1b*) and would additionally provide isolate information with clinical relevance (Unemo et al 2002). *porB*-based typing, both full-length and extended-length typing schemes, can be correlated to serovar types (Unemo et al 2003); however, the association between *porB* sequence types and serovar types remains to be confirmed by further comparison studies (Unemo & Dillon 2011).

This research established a modified *porB*-based molecular typing scheme using an extended length of the *porB* gene, covering ~82% and most variable regions of the entire *porB* gene. As compared to the typing scheme based on the sequences of the entire *porB* gene, this typing scheme is less costly and quicker to perform as it can be determined by one PCR reaction and 2 DNA sequencing reactions (one reaction for each strand). To obtain sequences of the entire

*porB* gene, two DNA sequencing reactions for each strand are often needed to achieve unambiguous sequence results. NG-MAST typing involves 2 PCR and 4 DNA sequencing reactions.

The index of discrimination (ID) for this new scheme is similar to the IDs of the NG-MAST analysis. It has been shown that NG-MAST analysis has high discriminatory power sufficient to distinguish *N. gonorrhoeae* isolates in short-term molecular epidemiological studies (Unemo and Dillon 2011). Using the typing scheme developed in this study, IDs of 0.932-0.968 was achieved, which is similar to the IDs (0.946-0.982) for the NG-MAST analysis of the same *N. gonorrhoeae* populations. Therefore, our results validated the use of this *porB*-based typing scheme in epidemiological studies, providing high discriminatory abilities similar to those of the NG-MAST analysis as well as full-length *porB*-based typing scheme used by others (Bash et al 2005; Fredlund et al 2004; Martin et al 2004; Olsen et al 2008; Unemo et al 2002, 2004, 2007; Ward et al 2000). NG-MAST had a slightly higher discriminatory power for typing *N. gonorrhoeae* isolates and further differentiated *porB* types. This additional differentiation ability is due to the sequence variations present in *tbpB* alleles (Harrison et al 2008; Choudhury et al 2006) which contributed to different NG-MAST STs. However, it is uncertain whether the differences detected in *tbpB* using NG-MAST are indicative of epidemiologically distinct groups of isolates and further study is required.

The extended-length *porB*-based typing scheme established in this study has the ability to confirm epidemiological sexual connections of gonorrhea cases. In this study, we observed a concordance rate of 93.2% between *porB* genotypes of isolates and epidemiologically reported sexual connections of patients (dyads and triads), which was confirmed by the NG-MAST analysis. Similar congruence rate (90.3%) was also reported by others using the NG-MAST typing method (Bilek et al 2007). However, a small number of patient self-identified sexual contacts harboured *N. gonorrhoeae* isolates with different *porB* sequences or NG-MAST STs, suggesting that the corresponding male and/or female patients might have had multiple sex partners infected with different *N. gonorrhoeae* strains, or that the patients might have mixed strain infections. Mixed strain infections are present in sexually active groups. To detect multiple

strains from cultures, *porB*-sequence typing of multiple individual colonies from the primary isolation plate is required (Unemo et al 2002). Alternatively, opa-typing of multiple individual colonies (O'Rourke et al 1995; Martin & Ison 2003) or *porB* variable region (VR) typing from clinical noncultured samples (Lynn et al 2005; Thompson et al 2000) can be used; however these methods may still only detect the predominant strain in a mixed infection.

Furthermore, large clusters, based on the modified *porB*-based typing or NG-MAST analysis was identified. For example, 42 isolates exhibited an identical *porB* sequence, and 27 of these isolates also displayed a single NG-MAST ST. Thus the modified *porB*-based typing scheme is able to identify epidemiologically unrevealed transmission networks, and this is confirmed by NG-MAST analysis. Further epidemiological investigation is warranted to determine whether the isolates clustered based on molecular typing are truly related in this study.

A molecular typing method should be able to retain information of epidemiological relatedness and sameness, such as observing a single genotypic type for different isolates from a single host and identifying epidemiological outbreaks (Riley 2004). Therefore, for short-term molecular epidemiological studies of *N. gonorrhoeae*, the *porB*-typing scheme developed in this study is appropriate and highly cost-effective.

Standardized guidelines should be established if *porB* DNA sequence analysis is to be used for widely studying *N. gonorrhoeae* molecular epidemiology to facilitate inter-laboratory comparisons and to differentiate *N. gonorrhoeae* clusters from different geographical regions. An independent *N. gonorrhoeae porB* DNA sequence database has not yet been established; a publicly accessible *N. gonorrhoeae porB* database is needed for sequence deposition, sequence type assignment, as well as spatial and temporal characterizations of *N. gonorrhoeae* isolate distribution. Further, some common *porB* type assignments should be established between NG-MAST assigned types and *porB* types based on larger *porB* segments. Overall, *porB* DNA sequence analysis is a useful tool for *N. gonorrhoeae* molecular epidemiology, particularly in resource-limited settings. The NG-MAST analysis can be used if higher discrimination is



required for further differentiating large *porB*-based clusters of *N. gonorrhoeae* (Choudhury et al 2000; Unemo & Dillon 2011).

#### **4.3.2 Construction of *porB*-based Gonorrhea Transmission Networks in Shanghai**

*porB*-based phylogenetic analysis may reveal potential connectors in gonorrhea transmission networks. As illustrated in Fig 3.17 of Section 3.3.4, the incongruent dyads or triads might serve as connectors between core groups in transmission chains. For example, the dyads D1 and D2 might connect sexual networks harboring *porB1a* or *porB1b* *N. gonorrhoeae* genotypes, respectively; dyad D4 might connect sexual networks harboring *N. gonorrhoeae* isolates with distinct *porB1b* genotypes. The triad T1 is important, in which one female partner (f1) carried a *N. gonorrhoeae* strain different from her male partner who had a *N. gonorrhoeae* strain identical to his other female partner (f2). Therefore, patient f1 must have obtained gonorrhea from other sexual partner(s) who are unrevealed in the epidemiological survey. Furthermore, there are several clusters identified by *porB* sequence analysis, linking several epidemiological dyads and triads. These clusters are potential sexual networks, which are broader than sexual networks revealed by contact tracing in this study. The large clusters with identical *porB* sequences could be the core groups of gonorrhea transmission networks in Shanghai in 2005.

Because discussion of sex is not well accepted in China, the patient self-reported sexual linkages are likely underestimated and thus sexual networks created using the patient-reported information cannot be readily observed. It also should be noted that isolates with identical *porB* sequences could possibly be further differentiated using different typing methods, such as opa-typing and MLST typing (O'Rourke et al 1995; Viscidi et al 2000, 2003; Bennett et al 2007; Tazi et al 2010). Therefore, future in-depth analysis of demographic, social and geographical data, coupled with genotypic data, would reveal better information of sexual networks in communities and better define specific transmission clusters.

It has been shown that the identification of a cluster of identical gonococcal isolates from individuals within a particular area and within a short time period can be used as an indicator that these individuals may be sexual contacts or part of a closely related chain of transmission, if the

typing method indexes genetic variation that accumulates rapidly (O'Rourke et al 1995; Ison 1998; Ward et al 2000; Martin et al 2004; Choudhury et al 2006; Risley et al 2007). Thus, my research has important implications in formulating gonorrhoea control programs by identifying transmission networks otherwise unrevealed. However, in practice, caution should be taken in the interpretation of these results. This type of approach in constructing sexual networks requires careful validation to ensure that clusters of identical gonococcal genotypes typically identify clusters of individuals with chains of transmission. In-depth comparison of concordance of clusters defined by molecular typing to those identified by empirical epidemiological surveys is warranted (Risley 2004).

#### **4.3.3 Strain Diversity of *N. gonorrhoeae* Revealed by *porB*-based Sequence Analysis**

*N. gonorrhoeae* population is highly diverse in their genetic characteristics. This is particularly reflected in surface-exposing protein-coding loci such as *porB* (Fudyk et al 1999; Pérez-Losada et al 2005). This study confirms the extent and nature of *porB* heterogeneity by phylogenetic analysis of *porB* in 3 independent population-based studies of *N. gonorrhoeae* isolates, e.g. SH2005, SH2008 and UQ2008. The average number of isolates per NG-MAST ST was 1.6 to 1.7; the number of isolates per *porB* sequence was 1.9 to 2.5 (Table 4.1). These results are generally consistent with the few reported gonococcal population studies by others. The reported number of isolates per NG-MAST ST ranged from 1.9 (Olsen et al 2008; Unemo et al 2007) to about 2.4 isolates (Martin et al 2004; Abu-Rajab et al 2009; Palmer et al 2006). As high as 4.6 isolates per NG-MAST ST (2045 isolates having 449 NG-MAST STs) was observed (Choudhury et al 2006); these isolates were collected in a one-year period in a gonorrhoea prevalent city London, UK. The reported number of isolates per *porB* sequence ranged from 1.24 (Unemo et al 2003) to about 2.0 isolates (Unemo et al 2007; Olsen et al 2008). Gonorrhoea occurrence rates can significantly affect the degrees of heterogeneity in gonococcal populations (Tazi et al 2010). In endemic populations, gonococcal isolates may be highly heterogeneous while in epidemic populations the gonococci may be more homogenous showing predominant circulating strains (Choudhury et al 2006). The slight differences in *porB* heterogeneity observed

from different studies may be due to the various gonorrhoea prevalence rates in communities or is because of different typing schemes used.

The study demonstrated, for the first time, that the *porB1b* genotype of *N. gonorrhoeae* is predominant in Shanghai and Urumchi, by showing that in all the 3 gonococcal populations studied, *porB1b* isolates accounted for over 63%. It has been reported that the *porB1b* type is more prevalent than the *porB1a* type in *N. gonorrhoeae* populations in Germany (Sandström et al 1982), Russia (Il'ina et al 2003, Unemo et al 2007), Sweden (Berglund et al 2001; Olsen et al 2008), and the United States (McKnew et al 1987, 2003). Prior to DNA sequence analysis to establish the prevalence of *porB* types, serological analysis was also used to indicate temporal and geographic differences between PIA and PIB phenotypes. For example, the PIB type (serogroups WII/III) was predominant in non-PPNG strains in Jamaica (Knapp et al 1984) and in Greece (Tzanakaki et al 1989), while PIA was prevalent in the Philippines and Singapore (Tam et al 1982). However, these studies used highly selected isolates and may not be fully representative of the broader *N. gonorrhoeae* population. The reason for type differences in different regions is not well understood, although host physiological factors, behavioral characteristics, and control programs such as antibiotic use, may play roles in evolutionary selection (Derrick et al 1999; Posada et al 2000, 2002).

The gonococcal isolates from Urumchi (UQ2008) comprised much higher proportion of *porB1a* type (36.4%) as compared to the gonococcal populations in Shanghai (12.3% - 27.0%). This could be due to the small sample size of the UQ2008. The collection of the UQ2008 isolates is presumed to be highly selective at the local STD clinics, resulting in lack of representative of gonococcal population within the region. However, it has been documented that *porB1a* gonococci are more likely to cause invasive and complicated infections (Sandström et al 1984; Tapsall et al 1992). Therefore, clinical investigation of gonorrhoea in Urumchi would be warranted to observe differences of clinical manifestations and outcomes of gonorrhoea between Shanghai and Urumchi and among *porB1a*- or *porB1b*-isolate harboring patients.

#### **4.3.4 Temporal Strain Distributions of *N. gonorrhoeae* in Shanghai**

The dynamics of temporal strain distribution of *N. gonorrhoeae* have been reported in other geographic locales by others. Using a probe-hybridization method of *porB* variable regions (VRs), McKnew et al (2003) studied gonococcal populations over a 10-year period (1991-2000) in Baltimore, Maryland. The most common *porB1b* strains varies from year to year; while the most common *porB1a* strains tend to persist across the 10-year period. Further, Sarafarin et al (1994) characterized a total of 432 PPNG strains from Honolulu, Hawaii during a 10-year period (1982-1991) using the auxotype/serovar (A/S) typing methods and reported that there was no evidence of endemic persistence of any strains during the study period. In the present study, we observed that both *porB1a* and *porB1b* gonococcal strains were diverse over time (2005 and 2008) in Shanghai although few common *porB1b* clusters persisted over the 3 year period. The largest *porB*-based clusters in the 2005 isolates were not present in the SH2008 isolates; instead, the SH2008 isolates had predominant strains which are significantly genetically different from the SH2005 isolates. A small portion of the SH2008 isolates carried *porB* sequences which were present in the SH2005 isolates. However, there is no tendency of strain clustering among 2005 and 2008 *N. gonorrhoeae* isolates in Shanghai.

However, particular predominant strain types which persist over time in a community have been observed by using other typing methods. Using the *opa*-typing method, Martin et al (2003) examined the genetic diversity over a 2-year study period of isolates from all consecutive patients with gonorrhoea attending the Genitourinary Medicine clinic in Sheffield, United Kingdom. Two *opa* genotypes were detected throughout the 2-year time period and comprised 41% of all isolates tested. Using a serovar typing method, Young et al (1992) examined *N. gonorrhoeae* isolates from Edingburgh for a 14-year period (1986 and 1990) and reported that frequency of isolates with serovar types Bajt (IB-3/IB-6) and Aedgkih (IA-1/IA-2) declined in parallel with an overall fall in the prevalence of gonorrhoea, whereas isolates with serovar type Bacejk (IB-1/IB-2) persisted at a fairly constant level.

The discrepancy may reflect differences of temporal dynamics of *N. gonorrhoeae* populations in different communities, such as in Shanghai, Baltimore and Sheffield. The

discrepancy can also be resulted from different typing methods which have various discriminatory abilities. In the Baltimore study (McKnew et al 2003), only certain variable regions (VRs) of *porB* were targeted by the probes, and particularly the hyper-variable region VR-4 of *porB* (Unemo et al 2003) was not included. The discriminatory ability of serotyping method alone which was used in the Edinburgh study (Young et al 1992) was not high enough for investigating temporal trends of strain distribution (Unemo & Dillon 2011).

#### **4.3.5 Spatial Strain Distribution of *N. gonorrhoeae***

Comparative study on strain types of *N. gonorrhoeae* populations among distant geographic locations has been sparse. Using a MLST typing scheme, Tazi et al (2010) found that there were no shared allelic profiles between the Shanghai and the Baltimore *N. gonorrhoeae* populations. Extensive variation in the repertoire of *porB* alleles was also observed between isolates from a gonorrhoea core group population (Nairobi, Kenya) and the *N. gonorrhoeae* isolates originated elsewhere (United Kingdom and North America) (Fudyk et al 1999).

The results of the present comparative study revealed that *N. gonorrhoeae* isolates from Urumchi were genetically distinct from those from Shanghai, confirming the findings of others. In the present study, *N. gonorrhoeae* isolates were collected during a similar time period for both populations. The implication in disease control is that using *porB* typing, introducing isolates can be identified, although this result needs to be validated using larger sample sizes.

#### **4.3.6 Conclusion**

In this study, a modified *porB* DNA sequence-based typing scheme has been developed and applied to short-term epidemiological studies. This typing scheme has been validated by comparing with the NG-MAST typing method and by examining concordance with epidemiologically revealed sexual contacts. Using this *porB*-based typing method, patterns of gonococcal strain distributions have been revealed in Shanghai and in Urumchi. Our results revealed that predominant strains differ over time and across geographical locations. The

majority of strains in 2005 and 2008 in Shanghai carried distinct *porB* sequences, and only a small proportion of strains shared common *porB* sequences over time. This study also revealed sexual contacts and sexual networks unrevealed in traditional contact tracing. The identification of large clusters, which may represent the “core” groups and the potential connectors in the gonorrhea transmission chains in Shanghai will help to design and modify control measures.

To globally track strain distribution and transmission of *N. gonorrhoeae*, an international database of gonococcal *porB* sequences is needed. One limitation of my research is the small sample sizes of gonococcal populations studied, in particular the SH2008 and UQ2005. Recruitment of more *N. gonorrhoeae* isolates in Shanghai 2008 or in Urumchi may reveal some common strains although in low frequency, be shared between the cities or over time in Shanghai. Further analysis by combining the genetic data with patients’ demographic information may confirm the sexual networks established on the genetic bases, and may reveal a clearer picture of sexual networks in the communities.

## **CHAPTER FIVE**

### **CONCLUSION REMARKS**

Gonorrhoea is a heavy public health burden worldwide. It has been estimated that the number of new cases each year increased from 62 million cases in 2001 to 82 million infections in 2010. Control of gonorrhoea relies on comprehensive strategies, including safe sex, early diagnosis and effective treatment of the infection, partner notification and identification of sexual networks for targets of prevention programs. Antibiotic treatment is one of the hallmarks in gonorrhoea control programs. However, the causative pathogen of gonorrhoea, *Neisseria gonorrhoeae*, has developed resistance to almost all antimicrobial agents used for the treatment, which has limited treatment options to only one class of antibiotics, third-generation cephalosporins.

Antibiotic treatment is the hallmark in curing gonococcal infections and controlling the spread of gonorrhoea. According to the accepted definition of gonococcal treatment efficacy, a cure rate of over 95% is required for an antibiotic to be recommended for gonorrhoea treatment. Thus, an antibiotic should not be used in situations where resistance is observed in greater than 3% to 5% of gonococcal isolates tested.

Surveillance systems are crucial to identify resistant infections for intervention and critically important in setting treatment guidelines. Currently, sentinel surveillance systems, so called the Gonococcal Antimicrobial Susceptibility Surveillance Programs (GASP), have been established and used for decades at local, national and international levels, and these systems are exemplified by the GASP in Western Pacific Region and in Southeast Asia Region, the GASP in Latin America and the Caribbean, the GASP in South Africa, the Gonococcal Isolate Susceptibility Project (GISP) in the United States, the GASP of the European Surveillance of Sexually Transmitted Infections (Euro-GASP of ESSTI) and the GASP in the Public Health Agency of Canada.

My research provides temporal (2005 and 2008) and spatial (Shanghai and Urumchi) information on gonococcal antimicrobial resistance in China. It is the first study showing a high prevalence of reduced susceptibility to ceftriaxone, a third-generation cephalosporin currently



the first-line antimicrobials for the treatment of gonorrhoea in China. This study also demonstrates that *N. gonorrhoeae* is persistently resistant to ciprofloxacin, penicillin and tetracycline, antibiotics which had been used for treating gonococcal infections in China and are no longer recommended. Spectinomycin is currently an alternative regimen for the treatment of gonorrhoea in China, and the increasing number of isolates with intermediate levels of susceptibility in Shanghai over time indicates the need of close monitoring.

Over their long history of evolution, bacteria have developed various ways to protect themselves from antimicrobial attacks. Some mechanisms mediate cross-resistance to multiple unrelated drugs, whereas more than one resistant mechanism can co-exist in a microorganism against a particular antibiotic. Gonococcal resistance to antimicrobial agents is generally classified as plasmid-mediated or chromosomally mediated resistance or both. Plasmid-mediated resistance confers high levels of resistance to penicillin (i.e. PPNG) or tetracycline (i.e. TRNG). PPNG isolates harbor  $\beta$ -lactamase producing plasmids; TRNG isolates contain *tetM*-containing plasmids. Mutations at various loci, singularly or in combination, are associated with chromosomally mediated resistance. The potential molecular determinants for antimicrobial resistance in *N. gonorrhoeae* include the quinolone resistance determining regions (*gyrA* and *parC*) and various mutations in the *porB*, *penA*, *mtrR* and *ponA* genes. The accumulation of chromosomal mutations can confer resistance to multiple antibiotics or higher levels of resistance to single antibiotics.

The present research systemically examined mutations in various loci in association with gonococcal resistance to different antibiotics. It is the first report with regards to molecular mechanisms of reduced susceptibility to third-generation cephalosporins in *N. gonorrhoeae* isolates from China. My results revealed that the molecular factors associated with reduced susceptibility to ceftriaxone include a *porB1b* (expressing PIB) genotype, a wild-type MtrR protein or double mutations in MtrR, and certain mutation combinations in PBP2 (*penA*). The present study demonstrated, for the first time, that molecular determinants of quinolone resistant *N. gonorrhoeae* are stable genetically and could remain long time in the post quinolone era.

Gonorrhea control strategies, as for other sexually transmitted infections, is achieved by a coordinated approach involving minimizing organism transmissibility, decreasing rate of partner exchange and reducing duration of infectiousness. Thereby identification of “core” groups of transmission, sexual networks and transmission patterns in communities is crucial for setting appropriate intervention. Molecular epidemiology, combinational application of molecular tools and traditional epidemiological studies provides many advantages for this purpose. The selection of molecular methods in molecular epidemiology mostly depends on study purposes, availability of resources and factors of cost-effective relationships.

In this cross sectional molecular epidemiological study, a modified *porB* DNA sequence-based typing scheme has been developed and applied. This typing scheme has been validated by comparing it with the NG-MAST (*N. gonorrhoeae* Multi-Antigen Sequence Typing) method, an internationally accepted molecular method for short-term molecular epidemiological studies, and also by examining concordance with epidemiologically revealed sexual contacts. Using the *porB*-based typing method, patterns of gonococcal strain distributions have been revealed in Shanghai and in Urumchi. My results revealed that predominant strains differ over time and across geographical locations. Majority of strains in 2005 and 2008 in Shanghai carried distinct *porB* sequences, and only a small proportion of strains shared common *porB* sequences over time. This study also revealed sexual contacts and sexual networks unrevealed by traditional contact tracing. The identification of large clusters, which may represent the “core” groups and the potential connectors in the gonorrhea transmission chains in Shanghai will help to design and modify control measures.

An international database of gonococcal *porB* sequences is needed for globally tracking strain distribution and transmission of *N. gonorrhoeae*. Recruitment of more *N. gonorrhoeae* isolates in Shanghai 2008 or in Urumchi may reveal some common strains although in low frequency, be shared between the cities or over time in Shanghai. Further analysis by combining the genetic data with patients’ demographic information may confirm the sexual networks established on the genetic bases, and may reveal a clearer picture of sexual networks in the communities.

**CHAPTER SIX**

**REFERENCES**

1. Akasaka S, Muratani T, Yamada Y, Inatomi H, Takahashi K, Matsumoto T. 2001. Emergence of cephem- and aztreonam-high-resistant *Neisseria gonorrhoeae* that does not produce beta-lactamase. *J Infect Chemother.* 7:49-50.
2. Allen VG, Farrell DJ, Rebbapragada A, Tan J, Tijet N, Perusini SJ, Towns L, Lo S, Low DE, Melano RG. 2011. Molecular analysis of antimicrobial resistance mechanisms in *Neisseria gonorrhoeae* isolates from Ontario, Canada. *Antimicrob Agents Chemother.* 55:703-712.
3. American Academy of Pediatrics. 2006. Gonococcal infections. In Pickering LK, Baker CJ, and McMillan JA (eds.), *Red Book: 2006 Report of the Committee on Infectious Diseases* 27th ed. American Academy of Pediatrics, Elk Grove Village, IL, pp. 301–309.
4. Ameyama S, Onodera S, Takahata M, Minami S, Maki N, Endo K, Goto H, Suzuki H, Oishi Y. 2002. Mosaic-like structure of penicillin-binding protein 2 Gene (*penA*) in clinical isolates of *Neisseria gonorrhoeae* with reduced susceptibility to cefixime. *Antimicrob Agents Chemother.* 46:3744-3749.
5. Anderson RM, May RM. 1992. *Infectious diseases of humans, dynamics and control*, 1<sup>st</sup> edition, p234. Oxford University Press, Oxford, England.
6. Bala M, Ray K, Gupta SM, Muralidhar S, Jain RK. 2007. Changing trends of antimicrobial susceptibility patterns of *Neisseria gonorrhoeae* in India and the emergence of ceftriaxone less susceptible *N. gonorrhoeae* strains. *J Antimicrob Chemother.* 60:582-586.
7. Bala M, Jain RK, Ray K. 2008. Antimicrobial susceptibility profile of resistance phenotypes of *Neisseria gonorrhoeae* in India. *Sex Transm Dis.* 35:588-591.
8. Ball P. 2000. Quinolone generations: natural history or natural selection? *J Antimicrob Chemother.* 46:17-24.
9. Barry PM, Klausner JD. 2009. The use of cephalosporins for gonorrhea: the impending problem of resistance. *Expert Opin Pharmacother.* 10:555-577.
10. Bash M, Zhu P, Gulati S, McKnew D, Rice P, Lynn F. 2005. *por* Variable-region typing by DNA probe hybridization is broadly applicable to epidemiologic studies of *Neisseria gonorrhoeae*. *J Clin Microbiol.* 43:1522-1530.
11. BASHH (British Association for Sexual Health and HIV). 2005. National guideline on the diagnosis and treatment of gonorrhoea in adults 2005.
12. Beattie T, Moyes A, Patrizio C, Young H. 1999. Subtyping of high-level plasmid-mediated tetracycline resistant *Neisseria gonorrhoeae* isolated in Scotland between 1992 and 1998. *Int J STD AIDS.* 10:646-651.
13. Belland RJ, Morrison SG, Ison C, Huang WM. 1994. *Neisseria gonorrhoeae* acquires mutations in analogous regions of *gyrA* and *parC* in fluoroquinolone-resistant isolates. *Mol Microbiol.* 14:371-380.
14. Bennett JS, Jolley KA, Sparling PF, Saunders NJ, Hart CA, Feavers IM, Maiden MC. 2007. Species status of *Neisseria gonorrhoeae*: evolutionary and epidemiological inferences from multilocus sequence typing. *BMC Biol.* 5:35.

15. Berglund T, Fredlund H, Giesecke J. 2001. Epidemiology of the reemergence of gonorrhoea in Sweden. *Sex Transm Dis.* 28: 111-114.
16. Bilek N, Martin IM, Bell G, Kinghorn GR, Ison CA, Spratt BG. 2007. Concordance between *Neisseria gonorrhoeae* genotypes recovered from known sexual contacts. *J Clin Microbiol.* 45: 3564-3567.
17. Blondeau JM. 2004. Fluoroquinolones: mechanism of action, classification, and development of resistance. *Surv Ophthalmol.* 49 (Suppl 2):S73-78.
18. Blondeau JM, Missaghi B. 2004. Gemifloxacin: a new fluoroquinolone. *Expert Opin Pharmacother.* 5:1117-1152.
19. Bolan G, Ehrhardt AA and Wasserheit JN. 1999. Gender perspectives and STDs, p. 117–127. *In* K K Holmes, PA Mardh, PF Sparling, SM Lemon, WE Stamm, P Piot, and JN Wasserheit (ed.), *Sexually transmitted diseases*, 3rd ed. McGraw-Hill, New York, N.Y., USA.
20. Boslego JW, Tramont EC, Takafuji ET, Diniega BM, Mitchell BS, Small JW, Khan WN, Stein DC. 1987. Effect of spectinomycin use on the prevalence of spectinomycin-resistant and of penicillinase-producing *Neisseria gonorrhoeae*. *N Engl J Med.* 317:272-278.
21. Brown ST, Pedersen HB, Holmes KK. 1977. Comparison of erythromycin base and estolate in gonococcal urethritis. *JAMA.* 238:1371-1373.
22. Brunham RC. 2005. Parran Award Lecture: insights into the epidemiology of sexually transmitted diseases from  $R_0 = \beta cD$ . *Sex Transm Dis.* 32:722-724.
23. Brunton J, Clare D, Meier MA. 1986. Molecular epidemiology of antibiotic resistance plasmids of *Haemophilus* species and *Neisseria gonorrhoeae*. *Rev Infect Dis.* 8:713-724.
24. Buchanan TM, Hildebrandt JF. 1981. Antigen-specific serotyping of *Neisseria gonorrhoeae*: characterization based upon principal outer membrane protein. *Infect Immun.* 32:985-994.
25. Bygdeman S, Danielsson D, Sandström E. Gonococcal W serogroups in Scandinavia. 1983. A study with polyclonal and monoclonal antibodies. *Acta Pathol Microbiol Immunol Scand B.* 91:293-305.
26. Cabral T, Jolly AM, Wylie JL. 2003. *Chlamydia trachomatis omp1* genotypic diversity and concordance with sexual network data. *J Infect Dis.* 187:279-286.
27. Cao V, Ratsima E, Van Tri D, Bercion R, Fonkoua MC, Richard V, Talarmin A. 2008. Antimicrobial susceptibility of *Neisseria gonorrhoeae* strains isolated in 2004-2006 in Bangui, Central African Republic; Yaoundé, Cameroon; Antananarivo, Madagascar; and Ho Chi Minh Ville and Nha Trang, Vietnam. *Sex Transm Dis.* 35:941-945.
28. Carballo M, Pauzé M, Dillon JR. 1990. Increase of *Neisseria gonorrhoeae* isolates with combined plasmid-mediated resistance to tetracycline (TRNG) and penicillin (PPNG). *Can Dis Wkly Rep.* 16:219-222.

29. Carballo M, Ng LK, Dillon JR. 1994. Detection of the *tetM* determinant in *Neisseria gonorrhoeae* using a non-radioactively labelled oligonucleotide probe. *Mol Cell Probes*. 8:205-208.
30. Carifo K, Catlin BW. 1973. *Neisseria gonorrhoeae* auxotyping: differentiation of clinical isolates based on growth responses on chemically defined media. *Appl Microbiol*. 26:223-230.
31. CDC (Centers for Disease Control and Prevention). 1976. Penicillinase-producing *Neisseria gonorrhoeae*. *MMWR*. 33:408-410.
32. CDC (Centers for Disease Control and Prevention). 1985. Tetracycline-resistant *Neisseria gonorrhoeae* – Georgia, Pennsylvania, New Hampshire. *MMWR Morb Mortal Wkly Rep*. 34:563-564, 569-570.
33. CDC (Centers for Disease Control and Prevention). 1987. Antibiotic-resistant strains of *Neisseria gonorrhoeae*: policy guidelines for detection, management and control. *MMWR*. 36[Suppl 5S]:13S.
34. CDC (Centers for Disease Control and Prevention). 1989. Sexually Transmitted Diseases Treatment Guidelines. *MMWR*. 38 Suppl 8:1-43.
35. CDC (Centers for Disease Control and Prevention). 1993. Sexually transmitted diseases treatment guidelines. *MMWR Recomm Rep*. 42(RR-14):1-102.
36. CDC (Centers for Disease Control and Prevention). 2005. Gonococcal Isolate Surveillance Project (GISP) Annual Report - 2004. Atlanta, GA, USA.
37. CDC (Centers for Disease Control and Prevention). 2006. Sexually transmitted disease treatment guidelines 2006. *MMWR Recomm. Rep*. 55(RR-11):1-94.
38. CDC (Centers for Disease Control and Prevention). 2007a. Update to CDC's sexually transmitted diseases treatment guidelines, 2006: fluoroquinolones no longer recommended for treatment of gonococcal infections. *MMWR* 56:332-336.
39. CDC (Centers for Disease Control and Prevention). 2007b. Sexually Transmitted Disease Surveillance 2005 Supplement, Gonococcal Isolate Surveillance Project (GISP) Annual Report 2005. Atlanta, GA, USA.
40. CDC (Centers for Disease Control and Prevention). 2008a. US rates of chlamydia, gonorrhoea, syphilis up in 2006: CDC. *Clin Infect Dis. (News)*. 46:iii.
41. CDC (Centers for Disease Control and Prevention). 2008b. Sexually Transmitted Disease Surveillance 2006 Supplement: Gonococcal Isolate Surveillance Project (GISP) Annual Report – 2006. Atlanta, GA, USA.
42. CDC (Centers for Disease Control and Prevention). 2010. Sexually transmitted disease treatment guidelines, 2010. *MMWR Morb Mortal Wkly Rep*. 59(RR12):50-52.
43. Chen ST, Clowes RC. 1987. Nucleotide sequence comparisons of plasmids pHD131, pJB1, pFA3, pFA7, and b-lactamase expression in *Escherichia coli*, *Haemophilus influenzae*, and *Neisseria gonorrhoeae*. *J Bacteriol*. 169:3124–3130.

44. Chen XS, Gong XD, Liang GJ and Zhang GC. 2000. Epidemiologic trends of sexually transmitted diseases in China. *Sex Transm Dis.* 27:138-142.
45. Chen XS, Yin YP, Liang GJ, Gong XD, Li HS, Pomerol G, Thuy N, Shi MQ, Yu YH. 2005. Sexually transmitted infections among female sex workers in Yunnan, China. *AIDS Patient Care STDS.* 19:853-860.
46. Chen XS, Yin YP, Chen LP, Thuy NT, Zhang GY, Shi MQ, Hu LH, Yu YH. 2006a. Sexually transmitted infections among pregnant women attending an antenatal clinic in Fuzhou, China. *Sex Transm Dis.* 33:296-301.
47. Chen XS, Yin YP, Gong XD, Liang GJ, Zhang WY, Pomerol G, Shi MQ, Wu SQ, Zhang GC. 2006b. Prevalence of sexually transmitted infections among long-distance truck drivers in Tongling, China. *Int J STD AIDS.* 17:304-308.
48. China CDC (China Center for Disease Control). 2006. [Bulletins China STI Report – 2005]. Nanjing, China.
49. China CDC (China Center for Disease Control). 2007a. [Bulletins China STI Report – 2006]. Nanjing, China.
50. China CDC (China Center for Disease Control). 2007b. [Guidelines for laboratory diagnosis of sexually transmitted diseases]. Yu YP et al edited. Shanghai Science Technology Publishing, Qin Zhou Road, Shanghai 200235, China.
51. China CDC (China Center for Disease Control). 2008. [Bulletins China STI Report – 2007]. Nanjing, China.
52. China CDC (China Center for Disease Control). 2009. [Bulletins China STI Report – 2008]. Nanjing, China.
53. China Ministry of Health. 2000. [Diagnostic Criteria and Management Principle of Sexually Transmitted Disease]. Beijing, China: Department of Diseases Control, Ministry of Health.
54. Chisholm SA, Neal TJ, Alawattagama AN, Birley HD, Howe RA, Ison CA. 2009. Emergence of high-level azithromycin resistance in *Neisseria gonorrhoeae* in England and Wales. *J Antimicrob Chemother.* 64:353-358.
55. Chisholm SA, Dave J, Ison CA. 2010. High-level Azithromycin resistance occurs in *Neisseria gonorrhoeae* as a result of a single point mutation in the 23S rRNA genes. *Antimicrob Agents Chemother.* 54:3812-3816.
56. Choudhury B, Risley CL, Ghani AC, Bishop CJ, Ward H, Fenton KA, Ison CA, Spratt BG. 2006. Identification of individuals with gonorrhoea within sexual networks: a population-based study. *Lancet.* 368:139-146.
57. Chung GT, Yoo JS, Oh HB, Lee YS, Cha SH, Kim SJ, Yoo CK. 2008. Complete genome sequence of *Neisseria gonorrhoeae* NCCP11945. *J Bacteriol.* 190:6035-6036.
58. Clamp M, Cuff J, Searle SM, Barton GJ. 2004. The Jalview Java alignment editor. *Bioinformatics.* 20:426-427.

59. Clendennen TE, Echeverria P, Saengeur S, Kees ES, Boslego JW, Wignall FS. 1992a. Antibiotic susceptibility survey of *Neisseria gonorrhoeae* in Thailand. *Antimicrob Agents Chemother.* 36:1682-1687.
60. Clendennen TE 3rd, Hames CS, Kees ES, Price FC, Rueppel WJ, Andrada AB, Espinosa GE, Kabrerra G, Wignall FS. 1992b. In vitro antibiotic susceptibilities of *Neisseria gonorrhoeae* isolates in the Philippines. *Antimicrob Agents Chemother.* 36:277-282.
61. CLSI (Clinical and Laboratory Standards Institute). 2006. Methods for dilution antimicrobial susceptibility tests for bacteria that grow aerobically—seventh edition: M7-A7. CLSI, Wayne, PA, USA; 2006 edition.
62. CLSI (Clinical and Laboratory Standards Institute). 2009. Methods for dilution antimicrobial susceptibility tests for bacteria that grow aerobically: M100-S19. CLSI, Wayne, PA, USA; 2009 edition.
63. Cohen MS. 2004. HIV and sexually transmitted diseases: lethal synergy. *Top HIV Med.* 12: 104-107.
64. Cohen MS, Henderson GE, Aiello P, Zheng H. 1996. Successful eradication of sexually transmitted diseases in the People's Republic of China: implications for the 21<sup>st</sup> century. *J Infect Dis.* 174 Suppl 2:S223-S229.
65. Cohen MS, Ping G, Fox K and Henderson GE. 2000. Sexually transmitted diseases in the People's Republic of China in Y2K: back to the future. *Sex Transm Dis.* 27:143-145.
66. Cole MJ, Chisholm SA, Hoffmann S, Stary A, Lowndes CM, Ison CA; 2010. European Surveillance of Sexually Transmitted Infections Network. European surveillance of antimicrobial resistance in *Neisseria gonorrhoeae*. *Sex Transm Infect.* 86:427-432.
67. Cooke SJ, de la Paz H, La Poh C, Ison CA, Heckels JE. 1997. Variation within serovars of *Neisseria gonorrhoeae* detected by structural analysis of outer-membrane protein PIB and by pulsed-field gel electrophoresis. *Microbiol.* 143 (Pt 4):1415-1422.
68. Cooke SJ, Jolley K, Ison CA, Young H, Heckels JE. 1998. Naturally occurring isolates of *Neisseria gonorrhoeae*, which display anomalous serovar properties, express PIA/PIB hybrid porins, deletions in PIB or novel PIA molecules. *FEMS Microbiol Lett.* 162:75-82.
69. Cornelissen CN, Anderson JE, Sparling PF. 1997. Characterization of the diversity and the transferrin-binding domain of gonococcal transferrin-binding protein 2. *Infect Immun.* 65:822-828.
70. Cornelissen CN, Anderson JE, Boulton IC, Sparling PF. 2000. Antigenic and sequence diversity in gonococcal transferrin-binding protein A. *Infect. Immun.* 68:4725–4735.
71. Courvalin P, Leclercq R. 2010. Antibiotics by classes and groups. In Courvalin P et al ed., *Antimibiogram*, p665. ESKA Publishing, ASM Press, Paul Lipscomb, 3808 SW Dosch Road, Portland, Oregon, 97239, USA.
72. Dan M. 2004. The use of fluoroquinolones in gonorrhoea: the increasing problem of resistance. *Expert Opin Pharmacother.* 5:829-854.



73. Danielsson D, Faruki H, Dyer D, Sparling PF. 1986. Recombination near the antibiotic resistance locus *penB* results in antigenic variation of gonococcal outer membrane protein I. *Infect Immun.* 52:529-533.
74. Day S, Ward H, Ison C, Bell G, Weber J. 1998. Sexual networks: the integration of social and genetic data. *Soc Sci Med.* 47:1981-1992.
75. De P, Singh AE, Wong T, Yacoub W, Jolly AM. 2004. Sexual network analysis of a gonorrhoea outbreak. *Sex Transm Infect.* 80:280-285.
76. Deguchi T, Yasuda M, Nakano M, Ozeki S, Ezaki T, Saito I, Kawada Y. 1996. Quinolone-resistant *Neisseria gonorrhoeae*: correlation of alterations in the GyrA subunit of DNA gyrase and the ParC subunit of topoisomerase IV with antimicrobial susceptibility profiles. *Antimicrob Agents Chemother.* 40:1020-1023.
77. Dehio C, Gray-Owen SD, Meyer TF. 1998. The role of neisserial Opa proteins in interactions with host cells. *Trends Microbiol.* 6:489-495.
78. De la Fuente L, Vazquez JA. 1992. Analysis of genetic variability of penicillinase non-producing *Neisseria gonorrhoeae* strains with different levels of susceptibility to penicillin. *J Med Microbiol.* 37:96-99.
79. Derrick JP, Urwin R, Suker J, Feavers IM, Maiden MC. 1999. Structural and evolutionary inference from molecular variation in *Neisseria* porins. *Infect Immun.* 67:2406-2413.
80. Detels R, Wu Z, Rotheram MJ, Li L, Guan J, Yin Y, Liang G, Lee M, Hu L; National Institute of Mental Health (NIMH) Collaborative HIV Prevention Trial Group. 2003. Sexually transmitted disease prevalence and characteristics of market vendors in eastern China. *Sex Transm Dis.* 30:803-808.
81. Dillon JR. 1992. National microbial surveillance of the susceptibility of gonococcal isolates to antimicrobial agents. *Can J Infect Dis.* 3:202-204.
82. Dillon JR, Carballo M. 1990. Molecular epidemiology and novel combinations of auxotype, serovar, and plasmid content in tetracycline-resistant *Neisseria gonorrhoeae* isolated in Canada. *Can J Microbiol.* 36:64-67.
83. Dillon JR, Pagotto F. 1999. Importance of drug resistance in gonococci: from mechanisms to monitoring. *Curr Opin Infect Dis.* 12:35-40.
84. Dillon JR, Yeung KH. 1989. Beta-lactamase plasmids and chromosomally mediated antibiotic resistance in pathogenic *Neisseria* species. *Clin Microbiol Rev.* 2 (Suppl):S125-133.
85. Dillon JR, Duck PD, Eidus L. 1978a. A comparison of the *in vitro* activity of rosamycin, erythromycin, spiramycin, penicillin and tetracycline against *N. gonorrhoeae*, including  $\beta$ -lactamase-producing isolates. *J Antimicrob Chemother.* 4:465-480.
86. Dillon JR, Eidus L, Diena BB. 1978b. Cross-Canada survey of susceptibility of *Neisseria gonorrhoeae* isolates to six antimicrobial agents. *Can Med Assoc J.* 119:223-228.

87. Dillon JR, Pauzé M, Yeung KH. 1983. Spread of penicillinase-producing and transfer plasmids from the gonococcus to *Neisseria meningitidis*. *Lancet*. 1:779-781.
88. Dillon JR, Pauzé M, Yeung KH. 1986. Molecular and epidemiological analysis of PPNG isolated in Canada 1976-1984. Evolution of novel auxotypes and  $\beta$ -lactamase-producing plasmids. *Genitourin Med*. 62:151-157.
89. Dillon JR, Bygdeman SM, Sandstrom EG. 1987a. Serological ecology of *Neisseria gonorrhoeae* (PPNG and non-PPNG) strains: Canadian perspective. *Genitourin Med*. 63:160-168.
90. Dillon JR, Carballo M, King SD, Brathwaite AR. 1987b. Auxotypes, plasmid contents, and serovars of gonococcal strains (PPNG and non-PPNG) from Jamaica. *Genitourin Med*. 63:233-238.
91. Dillon JR, Rahman M, Yeung K. 1993. Discriminatory power of typing schemes based on Simpson's index of diversity for *Neisseria gonorrhoeae*. *J Clin Microbiol* 31:2831-2833.
92. Dillon JR, Li H, Yeung KH, Aman TA. 1999. A PCR assay for discriminating *Neisseria gonorrhoeae*  $\beta$ -lactamase-producing plasmids. *Mol Cell Probes*. 13:89-92.
93. Dillon JR, Li H, Sealy J, Ruben M, The Caribbean Gonococcal Antimicrobial Susceptibility Program (GASP) Network, Prabhakar P. 2001a. Antimicrobial susceptibility of *Neisseria gonorrhoeae* isolates from three Caribbean countries - Trinidad, Guyana and St. Vincent. *Sex Transm Dis*. 28:508-514.
94. Dillon JR, Rubabaza JPA, Schwartz Benzaken A, Sardinha JCG, Li H, Campos Bandeira MJ, Dos Santos Fernando Filho E. 2001b. Reduced susceptibility to azithromycin and high percentages of penicillin and tetracycline resistance in *Neisseria gonorrhoeae* isolates from Manaus, Brazil. *Sex Transm Dis*. 28:521-526.
95. Dillon JR, Ruben M, Li H, Borthagaray G, Márquez C, Fiorito S, Galarza P, Portilla JL, León L, Agudelo CI, Sanabria OM, Maldonado A, Prabhakar P. 2006. Challenges in the control of gonorrhea in South America and the Caribbean: monitoring the development of resistance to antibiotics. *Sex Transm Dis*. 33:87-95.
96. Dougherty T, Koller A, Tomasz A. 1980. Penicillin-binding proteins of penicillin-susceptible and intrinsically resistant *Neisseria gonorrhoeae*. *Antimicrob Agents Chemother*. 18:730-737.
97. Duck PD, Dillon JR, Eidus L. 1978. The effects of thiamphenicol and chloramphenicol in inhibiting *N. gonorrhoeae* isolates. *Antimicrob Agents Chemother*. 14:788-790.
98. Fayemiwo SA, Müller EE, Gumede L, Lewis DA. Plasmid-mediated penicillin and tetracycline resistance among *Neisseria gonorrhoeae* isolates in South Africa: prevalence, detection and typing using a novel molecular assay. *Sex Transm Dis*. 2010 Oct 29. PubMed PMID: 21042234
99. Fayet O, Froment Y, Piffaretti JC. 1982.  $\beta$ -Lactamase specifying plasmids isolated from *Neisseria gonorrhoeae* have retained an intact right part of a Tn3-like transposon. *J Bacteriol*. 149:136-144.

100. Felsenstein J. 1985. Confidence intervals on phylogenetics: an approach using bootstrap. *Evolution*. 39:783-791.
101. Fleming DT, Wasserheit JN. 1999. From epidemiological synergy to public health policy and practice: the contribution of other sexually transmitted diseases to sexual transmission of HIV infection. *Sex Transm Infect*. 75:3-17.
102. Fredlund H, Falk L, Jurstrand M, Unemo M. 2004. Molecular genetic methods for diagnosis and characterisation of *Chlamydia trachomatis* and *Neisseria gonorrhoeae*: impact on epidemiological surveillance and interventions. *APMIS* 112:771-784.
103. Fudyk TC, Maclean IW, Simonsen JN, Njagi EN, Kimani J, Brunham RC, Plummer FA. 1999. Genetic diversity and mosaicism at the *por* locus of *Neisseria gonorrhoeae*. *J Bacteriol*. 181:5591-5599.
104. Galarza PG, Alcalá B, Salcedo C, Canigia LF, Buscemi L, Pagano I, Oviedo C, Vázquez JA. 2009. Emergence of high level azithromycin-resistant *Neisseria gonorrhoeae* strain isolated in Argentina. *Sex Transm Dis*. 36:787-788.
105. Galarza PG, Abad R, Canigia LF, Buscemi L, Pagano I, Oviedo C, Vázquez JA. 2010. New mutation in 23S rRNA gene associated with high level of azithromycin resistance in *Neisseria gonorrhoeae*. *Antimicrob Agents Chemother*. 54:1652-1653.
106. Galimand M, Gerbaud G, Courvalin P. 2000. Spectinomycin resistance in *Neisseria spp.* due to mutations in 16S rRNA. *Antimicrob Agents Chemother*. 44:1365-1366.
107. Galvin SR, Cohen MS. 2004. The role of sexually transmitted diseases in HIV transmission. *Nat Rev Microbiol*. 2:33-42.
108. Gascoyne-Binzi DM, Heritage J, Hawkey PM, Turner A, and van Klingeren B. 1991. Molecular evolution of tetracyclineresistance plasmids carrying TetM found in *Neisseria gonorrhoeae* from different countries. *J Antimicrob Chemother*. 28:173–183.
109. Gascoyne-Binzi DM, Hawkey PM, Heritage J. 1994. The distribution of variants of the *tetM* determinant in tetracycline-resistant *Neisseria gonorrhoeae*. *J Antimicrob Chemother*. 33:1011-1016.
110. Gerbase AC, Rowley JT, Heymann DH, Berkley SF, Piot P. 1998a. Global prevalence and incidence estimates of selected curable STDs. *Sex Transm Infect*. 74 (Suppl 1):S12-16.
111. Gerbase AC, Rowley JT, Mertens TE. 1998b. Global epidemiology of sexually transmitted diseases. *Lancet*. 351(S3):2–4.
112. Giles JA, Falconio J, Yuenger JD, Zenilman JM, Dan M, Bash MC. 2004. Quinolone resistance-determining region mutations and *por* type of *Neisseria gonorrhoeae* isolates: resistance surveillance and typing by molecular methodologies. *J Infect Dis*. 189:2085-2093.
113. Gill MJ, Jayamohan J, Lessing MP, Ison CA. 1994. Naturally occurring PIA/PIB hybrids of *Neisseria gonorrhoeae*. *FEMS Microbiol Lett*. 119:161-166.

114. Gill MJ, Simjee S, Al-Hattawi K, Robertson BD, Easmon CS, Ison CA. 1998. Gonococcal resistance to beta-lactams and tetracycline involves mutation in loop 3 of the porin encoded at the *penB* locus. *Antimicrob Agents Chemother.* 42:2799-2803.
115. Goldbloom RB. 1994. Prophylaxis for gonococcal and chlamydial ophthalmia neonatorum. In: Canadian Task Force on the Periodic Health Examination. *Canadian Guide to Clinical Preventive Health Care*, pp168-75. Health Canada. Ottawa. Canada.
116. Gorter AD, Oostrik J, van der Ley P, Hiemstra PS, Dankert J, van Alphen L. 2003. Involvement of lipooligosaccharides of *Haemophilus influenzae* and *Neisseria meningitidis* in defensin-enhanced bacterial adherence to epithelial cells. *Microb Pathog.* 34:121-130.
117. Gotschlich EC, Seiff ME, Blake MS and Koomey M. 1987. Porin protein of *Neisseria gonorrhoeae*: cloning and gene structure. *Proc Natl Acad Sci. USA.* 84:8135-8139.
118. Greco V, Ng LK, Catana R, Li H, Dillon JR. 2003. Molecular epidemiology of *Neisseria gonorrhoeae* isolates with plasmid-mediated tetracycline resistance in Canada: temporal and geographical trends (1986-1997). *Microb Drug Resist.* 9:353-360.
119. Gu W, Yang Y, Wu L, Gao Z, Zhang C, Tang Q, Zhang H, Hu W, Cheng Y, Wang H. 2004. [Surveillance of antibiotic susceptibility of *Neisseria gonorrhoeae* from 1988 to 2002 in Shanghai]. *Chin J Dermatol.* 37:323-325.
120. Hagman KE, Pan W, Spratt BG, Balthazar JT, Judd RC, Shafer WM. 1995a. Resistance of *Neisseria gonorrhoeae* to antimicrobial hydrophobic agents is modulated by the *mtrRCDE* efflux system. *Microbiology.* 141:611-22.
121. Hagman KE, Shafer WM. 1995b. Transcriptional control of the *mtr* efflux system of *Neisseria gonorrhoeae*. *J Bacteriol.* 177:4162-4165.
122. Hansen L, Wong T, Perrin M. 2003. Gonorrhoea resurgence in Canada. *Int J STD AIDS.* 14:727-731.
123. Handsfield HH, McCutchan JA, Corey L, Ronald AR. 1992. Evaluation of new anti-infective drugs for the treatment of uncomplicated gonorrhoea in adults and adolescents. Infectious Diseases Society of America and the Food and Drug Administration. *Clin Infect Dis.* 15 (Suppl 1):S123-130.
124. HPA (Health Protection Agency UK). 2005. National guideline on the diagnosis and treatment of gonorrhoea in adults. *Int J STD & AIDS.* 20:453-457.
125. HPA (Health Protection Agency UK). 2008. GRASP (the Gonococcal Resistance to Antimicrobials Surveillance Programme) 2007 Report: Trends in Antimicrobial Resistant Gonorrhoea. London, UK.
126. HPA (Health Protection Agency UK). 2009. GRASP (The Gonococcal Resistance to Antimicrobials Surveillance Programme) 2008 Report: Trends in Antimicrobial Resistant Gonorrhoea. London, UK.
127. HPA (Health Protection Agency UK). 2011. Drafted United Kingdom National Guideline for the Diagnosis and Treatment of Gonorrhoea in Adults. 2010 v5. London, UK. Available at <http://www.bashh.org/guidelines> (accessed on March 10, 2011).

128. Ho D. 2000. Alexander Fleming, Scientist and thinkers. Time 100, Time (magazine). <http://205.188.238.181/time/time100/scientist/profile/fleming.html>.
129. Hobbs MM, Alcorn TM, Davis RH, Fischer W, Thomas JC, Martin I, Ison C, Sparling PF, Cohen MS. 1999. Molecular typing of *Neisseria gonorrhoeae* causing repeated infections: evolution of porin during passage within a community. J Infect Dis. 179:371-381.
130. Holmes KK, Johnson DW, Trostle HJ. 1970. An estimate of the risk of men acquiring gonorrhea by sexual contact with infected females. Am J Epidemiol. 91:170-174.
131. Hook EW, and Handsfield HH. 1999. Gonococcal infections in the adult, p. 451–466. In K. K. Holmes, P.-A. Mardh, P. F. Sparling, S. M. Lemon, W. E. Stamm, P. Piot, and J. N. Wasserheit (ed.), Sexually transmitted diseases, 3rd ed. McGraw-Hill, New York, N.Y., USA
132. Hooper RR, Reynolds GH, Jones OG, Zaidi A, Wiesner PJ, Latimer KP, Lester A, Campbell AF, Harrison WO, Karney WW, Holmes KK. 1978. Cohort study of venereal disease. I: the risk of gonorrhea transmission from infected women to men. Am J Epidemiol. 108:136-144.
133. Howie HL, Glogauer M, So M. 2005. The *N. gonorrhoeae* type IV pilus stimulates mechanosensitive pathways and cytoprotection through a pilT-dependent mechanism. PLoS Biol. 3(4):e100.
134. Hu M, Nandi S, Davies C, Nicholas RA. 2005. High-level chromosomally mediated tetracycline resistance in *Neisseria gonorrhoeae* results from a point mutation in the *rpsJ* gene encoding ribosomal protein S10 in combination with the *mtrR* and *penB* resistance determinants. Antimicrob Agents Chemother. 49:4327-4334.
135. Hughes G, Andrews N, Catchpole M, Goldman M, Forsyth-Benson D, Bond M, Myers A. 2000. Investigation of the increased incidence of gonorrhoea diagnosed in genitourinary medicine clinics in England, 1994-6. Sex Transm Infect. 76:18-24.
136. Hunter PR, Gaston MA. 1988. Numerical index of the discriminatory ability of typing systems: an application of Simpson's index of diversity. J Clin Microbiol. 26:2465-2466.
137. Il'ina EN, Malakhova MV, Vereshchagin VA, Govorun VM, Sergienko VI, Zubkov MM, Vasil'ev MM, Kubanova AA. 2003. Molecular typing of *N. gonorrhoeae* strains prevalent in the Russian Federation. Bull Exp Biol Med. 136:179-182.
138. Ison CA. 1998. Genotyping of *N. gonorrhoeae*. Curr Opin Infect Dis. 11:43-46.
139. Ison CA, Terry P, Bendayna K, Gill MJ, Adams J, Woodford N. 1988. Tetracycline-resistant gonococci in UK. Lancet. 1:651-652.
140. Ison CA, Tekki N, Gill MJ. 1993. Detection of the *tetM* determinant in *Neisseria gonorrhoeae*. Sex Transm Dis. 20:329-333.
141. Ison CA, Dillon JA, Tapsall JW. 1998. The epidemiology of global antibiotic resistance among *Neisseria gonorrhoeae* and *Haemophilus ducreyi*. Lancet. 351 Suppl 3:8-11.

142. Ito M, Yasuda M, Yokoi S, Ito S, Takahashi Y, Ishihara S, Maeda S, Deguchi T. 2004. Remarkable increase in central Japan in 2001-2002 of *Neisseria gonorrhoeae* isolates with decreased susceptibility to penicillin, tetracycline, oral cephalosporins, and fluoroquinolones. *Antimicrob Agents Chemother.* 48:3185-3187.
143. Ito M, Deguchi T, Mizutani KS, Yasuda M, Yokoi S, Ito S, Takahashi Y, Ishihara S, Kawamura Y, Ezaki T. 2005. Emergence and spread of *Neisseria gonorrhoeae* clinical isolates harboring mosaic-like structure of penicillin-binding protein 2 in Central Japan. *Antimicrob Agents Chemother.* 49:137-143.
144. Iverson CJ, Wang SA, Lee MV, Ohye RG, Trees DL, Knapp JS, Effler PV, O'connor NP, Levine WC. 2004. Fluoroquinolone resistance among *Neisseria gonorrhoeae* isolates in Hawaii, 1990-2000: role of foreign importation and increasing endemic spread. *Sex Transm Dis.* 31:702-708.
145. Jajosky R. 2006. Summary of notifiable diseases 2004—United States. *MMWR.* 53:1–79.
146. Jap Soc STD. 2006. Guidelines for the diagnosis and treatment of sexually transmitted diseases 2006. *Jap J Sex Transm Dis.* 17 (Suppl 1):35–39.
147. Jayaraman R. 2008. Bacterial persistence: some new insights into an old phenomenon. *J Biosci.* 33:795-805.
148. Jayaraman R. 2009. Antibiotic resistance: an overview of mechanisms and a paradigm shift. *Curr Sci.* 96:1475-1484.
149. Jiang J, Cao N, Zhang J, Xia Q, Gong X, Xue H, Yang H, Zhang G, Shao C. 2006. High prevalence of sexually transmitted diseases among men who have sex with men in Jiangsu Province, China. *Sex Transm Dis.* 33:118-123.
150. Jolly AM, Wylie JL. 2002. Gonorrhoea and chlamydia core groups and sexual networks in Manitoba. *Sex Transm Infect.* 78(S1):i145-i151.
151. Källström H, Islam MS, Berggren PO, Jonsson AB. 1998. Cell signaling by the type IV pili of pathogenic *Neisseria*. *J Biol Chem.* 273:21777-21782.
152. Kampmeier RH. 1983. Introduction of sulfonamide therapy for gonorrhoea. *Sex Transm Dis.* 10:81-84.
153. Kehrenberg C, Schwarz S. 2007. Mutations in 16S rRNA and ribosomal protein S5 associated with high-level spectinomycin resistance in *Pasteurella multocida*. *Antimicrob Agents Chemother.* 51:2244-2246.
154. Kellogg DS, Peacock WL, Deacon WE, Brown L, Pirkle Carl I. 1963. *Neisseria gonorrhoeae*. I.: Virulence Genetically Linked to Clonal Variation. *J Bacteriol.* 85:1274–1279.
155. Khodursky AB, Zechiedrich EL, Cozzarelli NR. 1995. Topoisomerase IV is a target of quinolones in *Escherichia coli*. *Proc Natl Acad Sci U S A.* 92:11801-11805.
156. Kilbourne ED. 1973. The molecular epidemiology of influenza. *J Infect Dis.* 127:478-487.

157. Knapp JS, Tam MR, Nowinski RC, Holmes KK, Sandström EG. 1984. Serological classification of *Neisseria gonorrhoeae* with use of monoclonal antibodies to gonococcal outer membrane protein I. *J Infect Dis.* 150:44-48.
158. Knapp JS. 1988. Historical perspectives and identification of *Neisseria* and related species. *Clin Microbiol Rev.* 1:415-431.
159. Kohl PK, Ison CA, Danielsson D, Knapp JS, Petzoldt D. 1990. Current status of serotyping of *Neisseria gonorrhoeae*. *Eur J Epidemiol.* 6:91-95.
160. Larkin MA, Blackshields G, Brown NP, Chenna R, McGettigan PA, McWilliam H, Valentin F, Wallace IM, Wilm A, Lopez R, Thompson JD, Gibson TJ, Higgins DG. 2007. Clustal W and Clustal X version 2.0. *Bioinformatics.* 23:2947-2948.
161. Llarrull LI, Testero SA, Fisher JF, Mobashery S. 2010. The future of the  $\beta$ -lactams. *Curr Opin Microbiol.* 13:551-557.
162. Lee SG, Lee H, Jeong SH, Yong D, Chung GT, Lee YS, Chong Y, Lee K. 2010. Various *penA* mutations together with *mtrR*, *porB* and *ponA* mutations in *Neisseria gonorrhoeae* isolates with reduced susceptibility to cefixime or ceftriaxone. *J Antimicrob Chemother.* 65:669-675.
163. Lees R. 1946. Treatment of sulphonamide-resistant gonorrhoea by penicillin. *Br Med J.* 1:605-606.
164. Lewis DA. 2010. The Gonococcus fights back: is this time a knock out? *Sex Transm Infect.* 86:415-421.
165. Lewis DA, Scott L, Slabbert M, Mhlongo S, van Zijl A, Sello M, du Plessis N, Radebe F, Wasserman E. 2008. Escalation in the relative prevalence of ciprofloxacin-resistant gonorrhoea among men with urethral discharge in two South African cities: association with HIV seropositivity. *Sex Transm Infect.* 84:352-355.
166. Li H, Dillon JR. 1995. Utility of ribotyping, restriction endonuclease analysis and pulsed-field gel electrophoresis to discriminate between isolates of *Neisseria gonorrhoeae* of serovar IA-2 which require arginine, hypoxanthine or uracil for growth. *J Med Microbiol.* 43:208-215.
167. Liao M, Bell K, Gu W-M, Yang Y, Eng NF, Fu W, Wu L, Zhang C-G, Chen Y, Jolly AM, Dillon JR. 2008. Clusters of circulating *Neisseria gonorrhoeae* strains and association with antimicrobial resistance in Shanghai. *J Antimicrob Chemother.* 61:478-487.
168. Liao M, Helgeson S, Gu W-M, Yang Y, Jolly AM, Dillon JR. 2009. Comparison of *Neisseria gonorrhoeae* Multiantigen Sequence Typing and *porB* sequence analysis for identification of clusters of *N. gonorrhoeae* isolates. *J Clin Microbiol.* 47:489-491.
169. Liao M, Gu MM, Yang Y, Dillon JR. 2011. Analysis of mutations in multiple loci of *Neisseria gonorrhoeae* isolates reveals effects of PIB, PBP2 and MtrR on reduced susceptibility to ceftriaxone. *J Antimicrob Chemother.* 66:1016-1023.

170. Lindberg R, Fredlund H, Nicholas R, Unemo M. 2007. *Neisseria gonorrhoeae* isolates with reduced susceptibility to cefixime and ceftriaxone: association with genetic polymorphisms in *penA*, *mtrR*, *porB1b*, and *ponA*. *Antimicrob Agents Chemother.* 51:2117-2122.
171. Lo JY, Ho KM, Leung AO, Tiu FS, Tsang GK, Lo AC, Tapsall JW. 2008. Ceftributen resistance and treatment failure of *Neisseria gonorrhoeae* infection. *Antimicrob Agents Chemother.* 52:3564-3567.
172. Lucas CE, Balthazar JT, Hagman KE, Shafer WM. 1997. The MtrR repressor binds the DNA sequence between the *mtrR* and *mtrC* genes of *Neisseria gonorrhoeae*. *J Bacteriol.* 179:4123-4128.
173. Lundbäck D, Fredlund H, Berglund T, Wretling B, Unemo M. 2006. Molecular epidemiology of *Neisseria gonorrhoeae*- identification of the first presumed Swedish transmission chain of an azithromycin-resistant strain. *APMIS* 114:67-71.
174. Lynn F, Hobbs MM, Zenilman JM, Behets FM, Van Damme K, Rasamindrakotroka A, Bash MC. 2005. Genetic typing of the porin protein of *Neisseria gonorrhoeae* from clinical noncultured samples for strain characterization and identification of mixed gonococcal infections. *J Clin Microbiol.* 43:368-375.
175. MacDonald N, Mailman T, Desai S. 2008. Gonococcal infections in newborns and in adolescents. *Adv Exp Med Biol.* 609:108-130.
176. Maiden MC. 2006. Multilocus sequence typing of bacteria. *Annu Rev Microbiol.* 60:561-588.
177. Maiden MC, Bygraves JA, Feil E, Morelli G, Russell JE, Urwin R, Zhang Q, Zhou J, Zurth K, Caugant DA, Feavers IM, Achtman M, Spratt BG. 1998. Multilocus sequence typing: a portable approach to the identification of clones within populations of pathogenic microorganisms. *Proc Natl Acad Sci U S A.* 95:3140-3145.
178. Marians KJ, Hiasa H. 1997. Mechanism of quinolone action. A drug-induced structural perturbation of the DNA precedes strand cleavage by topoisomerase IV. *J Biol Chem.* 272:9401-9409.
179. Martin IM, Ison CA. 2003. Detection of mixed infection of *Neisseria gonorrhoeae*. *Sex Transm Infect.* 79:56-58.
180. Martin IM, Ghani A, Bell G, Kinghorn G, Ison CA. 2003. Persistence of two genotypes of *Neisseria gonorrhoeae* during transmission. *J Clin Microbiol.* 41:5609-5614.
181. Martin IM, Ison CA, Aanensen DM, Fenton KA, Spratt BG. 2004. Rapid sequence-based identification of gonococcal transmission clusters in a large metropolitan area. *J Infect Dis.* 189:1497-1505.
182. Martin IM, Hoffmann S, Ison CA; ESSTI Network. 2006. European Surveillance of Sexually Transmitted Infections (ESSTI): the first combined antimicrobial susceptibility data for *Neisseria gonorrhoeae* in Western Europe. *J Antimicrob Chemother.* 58:587-593.
183. Martínez-Martínez L, Pascual A, Jacoby GA. 1998. Quinolone resistance from a transferable plasmid. *Lancet.* 351:797-799.



184. Martínez-Martínez L, Eliecer Cano M, Manuel Rodríguez-Martínez J, Calvo J, Pascual A. 2008. Plasmid-mediated quinolone resistance. *Expert Rev Anti Infect Ther.* 6:685-711.
185. Marquez CM, Dillon JR, Rodriguez V, Borthagary G. 2002. Detection of a novel TetM determinant in tetracycline-resistant *Neisseria gonorrhoeae* from Uruguay, 1996–1999. *Sex Transm Dis.* 29:792–797.
186. Maslow JN, Mulligan ME, Arbeit RD. 1993. Molecular epidemiology: application of contemporary techniques to the typing of microorganisms. *Clin Infect Dis.* 17:153-162.
187. May RM, Anderson RM. 1987. Transmission dynamics of HIV infection. *Nature.* 326:137-142.
188. McGee ZA, Stephens DS, Hoffman LH, Schlech WF III, Horn RG. 1983. Mechanisms of mucosal invasion by pathogenic *Neisseria*. *Rev Infect Dis.* 5:S708-S714.
189. McKnew DL, Lynn F, Zenilman JM, Bash MC. 2003. Porin variation among clinical isolates of *Neisseria gonorrhoeae* over a 10-year period, as determined by *por* variable region typing. *J Infect Dis.* 187:1213-1222.
190. Merz AJ, So M. 2000. Interactions of pathogenic neisseriae with epithelial cell membranes. *Annu Rev Cell Dev Biol.* 16:423-457
191. Miller WC, Ford CA, Morris M, Handcock MS, Schmitz JL, Hobbs MM, Cohen MS, Harris KM, Udry JR. 2004. Prevalence of chlamydial and gonococcal infections among young adults in the United States. *JAMA.* 2291:2229-2236.
192. Moreno JG, Dillon JR, Arroyave R, Maldonado A, Fich F, Salvo A, Villalobos D, Pauzé M. 1987. Identification of penicillinase-producing *N. gonorrhoeae* (PPNG) in Chile during clinical and microbiological investigations of gonococcal susceptibility to antimicrobial agents. *Genitourin Med.* 63:6-12.
193. Morse SA, Beck-Sague CM. 1999. Gonorrhoea, p.151-174. *In* P.J. Hitchcock, H.T. Mackay, J.N. Wasserheit and R. Binder (ed.), *Sexually transmitted diseases and adverse outcomes of pregnancy.* ASM Press, Washington, D.C., USA
194. Morse SA, Johnson SR, Biddle JW, Roberts MC. 1986. High level tetracycline resistance in *Neisseria gonorrhoeae* is result of acquisition of Streptococcal *tetM* determinant. *Antimicrob Agents Chemother.* 30:664-670.
195. Müller A, Günther D, Dux F, Naumann M, Meyer TF, Rudel T. 1999. Neisserial porin (PorB) causes rapid calcium influx in target cells and induces apoptosis by the activation of cysteine proteases. *EMBO J.* 18:339-352.
196. Newman LM, Moran JS, Workowski KA. 2007. Update on the management of gonorrhea in adults in the United States. *Clin Infect Dis.* 44 Suppl 3:S84-101.
197. Ng LK, Dillon JR. 1993. Typing by serovar, antibiogram, plasmid content, riboprobing, and isoenzyme typing to determine whether *Neisseria gonorrhoeae* isolates requiring proline, citrulline, and uracil for growth are clonal. *J Clin Microbiol.* 31:1555-1561.

198. Ng LK, Carballo M, Dillon JR. 1995. Differentiation of *Neisseria gonorrhoeae* isolates requiring proline, citrulline, and uracil by plasmid content, serotyping, and pulsed-field gel electrophoresis. *J Clin Microbiol.* 33:1039-1041.
199. Ng LK, Sawatzky P, Martin IE, Booth S. 2002a. Characterization of ciprofloxacin resistance in *Neisseria gonorrhoeae* isolates in Canada. *Sex Transm Dis.* 29:780-788.
200. Ng LK, Martin I, Liu G, Bryden L. 2002b. Mutation in 23S rRNA associated with macrolide resistance in *Neisseria gonorrhoeae*. *Antimicrob Agents Chemother.* 46:3020-3025.
201. Ng LK, Martin I, Lau A. 2003. Trends of chromosomally mediated antimicrobial resistance in *Neisseria gonorrhoeae* in Canada: 1994-1999. *Sex Transm Dis.* 30:896-900.
202. Nordvik MK, Liljeros F. 2006. Number of sexual encounters involving intercourse and the transmission of sexually transmitted infections. *Sex Transm Dis.* 33:342-349.
203. Ochiai S, Sekiguchi S, Hayashi A, Shimadzu M, Ishiko H, Matsushima-Nishiwaki R, Kozawa O, Yasuda M, Deguchi T. 2007. Decreased affinity of mosaic-structure recombinant penicillin-binding protein 2 for oral cephalosporins in *Neisseria gonorrhoeae*. *J Antimicrob Chemother.* 60:54-60.
204. Olesky M, Hobbs M, Nicholas RA. 2002. Identification and analysis of amino acid mutations in porin IB that mediate intermediate-level resistance to penicillin and tetracycline in *Neisseria gonorrhoeae*. *Antimicrob Agents Chemother.* 46:2811-2820.
205. Olesky M, Zhao S, Rosenberg RL, Nicholas RA. 2006. Porin-mediated antibiotic resistance in *Neisseria gonorrhoeae*: ion, solute, and antibiotic permeation through PIB proteins with *penB* mutations. *J Bacteriol.* 188:2300-2308.
206. Olsen B, Hadad R, Fredlund H, Unemo M. 2008. The *Neisseria gonorrhoeae* population in Sweden during 2005-phenotypes, genotypes and antibiotic resistance. *APMIS* 116:181-189.
207. O'Rourke M, Ison CA, Renton AM, Spratt BG. 1995. Opa-typing: a high-resolution tool for studying the epidemiology of gonorrhoea. *Mol Microbiol.* 17:865-875.
208. Osaka K, Takakura T, Narukawa K, Takahata M, Endo K, Kiyota H, Onodera S. 2008. Analysis of amino acid sequences of penicillin-binding protein 2 in clinical isolates of *Neisseria gonorrhoeae* with reduced susceptibility to cefixime and ceftriaxone. *J Infect Chemother.* 14:195-203.
209. Ota KV, Jamieson F, Fisman DN, Jones KE, Tamari IE, Ng LK, Towns L, Rawte P, Di Prima A, Wong T, Richardson SE. 2009. Prevalence of and risk factors for quinolone-resistant *Neisseria gonorrhoeae* infection in Ontario. *CMAJ.* 180:287-290.
210. Pace NR, Olsen GJ, Woese CR. 1986. Ribosomal RNA phylogeny and the primary lines of evolutionary descent. *Cell.* 45:325-326.
211. Page RDM. 1996. Treeview: an application to display phylogenetic trees on personal computers. *CABIOS.* 12:357-358

212. Pagotto F, Aman AT, Ng L-K, Yeung KH, Brett M, Dillon JR. 2000. Sequence analysis of the family of penicillinase-producing plasmids of *Neisseria gonorrhoeae*, Plasmid. 43:24-34.
213. Palmer HM, Leming JP, Turner A. 2001. Investigation of an outbreak of ciprofloxacin-resistant *Neisseria gonorrhoeae* using a simplified opa-typing method. Epidemiol Infect. 126:219-224.
214. Parish WL, Laumann EO, Cohen MS, Pan S, Zheng H, Hoffman I, Wang T, Ng KH. 2003. Population-based study of chlamydial infection in China: a hidden epidemic. JAMA. 289:1265-1273.
215. Peeling RW, Mabey D, Herring A, Hook EW 3rd. 2006. Why do we need quality-assured diagnostic tests for sexually transmitted infections? Nat Rev Microbiol. 4:909-921.
216. Percival A, Rowlands J, Corkill JE, Alergant CD, Arya OP, Rees E, Annels EH. 1976. Penicillinase-producing Gonococci in Liverpool. Lancet. 2:1379-1382.
217. Pérez-Losada M, Viscidi R, Demma J, Zenilman J, Crandall K. 2005. Population genetics of *Neisseria gonorrhoeae* in a high-prevalence community using a hypervariable outer membrane *porB* and 13 slowly evolving housekeeping genes. Mol Biol Evol. 22:1887-1902.
218. Plitt S, Boyington C, Sutherland K, Lovgren M, Tilley P, Read R, Singh AE. 2009. Antimicrobial resistance in gonorrhea: the influence of epidemiologic and laboratory surveillance data on treatment guidelines: Alberta, Canada 2001-2007. Sex Transm Dis. 36:665-9.
219. Poh CL, Lau QC, Chow VT. 1995a. Differentiation of *Neisseria gonorrhoeae* IB-3 and IB-7 serovars by direct sequencing of protein IB gene and pulsed-field gel electrophoresis. J Med Microbiol. 43:201-207.
220. Poh CL, Loh GK, Tapsall JW. 1995b. Resolution of clonal subgroups among *Neisseria gonorrhoeae* IB-2 and IB-6 serovars by pulsed-field gel electrophoresis. Genitourin. Med. 71:145-149.
221. Pagotto F, Aman T, Ng LK, Yeung KH, Brett M, Dillon JR. 2000. Sequence analysis of the family of penicillinase-producing plasmids of *Neisseria gonorrhoeae* based on DNA sequencing. Plasmid 43:24-34.
222. Posada D, Crandall KA, Nguyen M, Demma JC, Viscidi RP. 2000. Population genetics of the *porB* gene of *Neisseria gonorrhoeae*: different dynamics in different homology groups. Mol Biol Evol. 17:423-436.
223. Posada D, Crandall KA, Holmes EC. 2002. Recombination in evolutionary genomics. Annu Rev Genet. 36:75-97.
224. Potterat JJ, Rothenberg RB, Woodhouse DE, Muth JB, Pratts CI, Fogle JS 2nd. 1985. Gonorrhea as a social disease. Sex Transm Dis. 12:25-32.
225. PHAC (Public Health Agency of Canada). 2006. Canadian Guidelines on Sexually Transmitted Infections (STI) 2006 Edition. Ottawa, ON, Canada.

226. PHAC (Public Health Agency of Canada). 2007. Canadian Sexually Transmitted Infections Surveillance Report 2004. *Can Com Dis Rep.* 33S1:17-25.
227. PHAC (Public Health Agency of Canada). 2008a. Brief Report on Sexually Transmitted Infections in Canada: 2007. <http://www.phac-aspc.gc.ca/publicat/2009/sti-its/index-eng.php>.
228. PHAC (Public Health Agency of Canada). 2008b. Canadian Guidelines on Sexually Transmitted Infections, 2008 Edition. Ottawa, ON, Canada.
229. PHAC (Public Health Agency of Canada). 2008c. <http://www.phac-aspc.gc.ca/publicat/2008/sti-its/gonorrhoe-eng.php>. Date accessed 12 December 2010.
230. PHAC (Public Health Agency of Canada). 2010. Reported cases of notifiable STI from January 1 to December 31, 2008 and January 1 to December 31, 2009 and corresponding annual rates for January 1 to December 31, 2008 and 2009. <http://www.phac-aspc.gc.ca/std-mts/stdcases-casmts/cases-cas-09-eng.php>.
231. Retzer MD, Yu R-H, Schryvers AB. 1999. Identification of sequences in human transferrin that bind to the bacterial receptor protein, transferrin-binding protein B. *Mol Microbiol.* 32:111–121.
232. Reyn A, Korner B, Bentzon MW. 1958. Effects of penicillin, streptomycin, and tetracycline on *N. gonorrhoeae* isolated in 1944 and in 1957. *Br J Vener Dis.* 34:227-239.
233. Riley LW. 2004. Molecular epidemiology of infectious disease: principles and practices. ASM Press, Washington DC, USA. c2004.
234. Risley CL, Ward H, Choudhury B, Bishop CJ, Fenton KA, Spratt BG, Ison CA, Ghani AC. 2007. Geographical and demographic clustering of gonorrhoea in London. *Sex Transm Infect.* 83:481-487.
235. Roberts MC. 1989. Plasmids of *Neisseria gonorrhoeae* and other *Neisseria* species. *Clin Microbiol Rev.* 2:S18–S23.
236. Roberts MC. 2004. Resistance to macrolide, lincosamide, streptogramin, ketolide, and oxazolidinone antibiotics. *Mol Biotechnol.* 28:47-62.
237. Roberts MC, Wagenvoort JH, van Klingeren B, Knapp JS. 1988. tetM- and beta-lactamase-containing *Neisseria gonorrhoeae* (tetracycline resistant and penicillinase producing) in The Netherlands. *Antimicrob Agents Chemother.* 32:158.
238. Roberts MC, Chung WO, Roe D, Xia M, Marquez C, Borthagaray G, Whittington WL, Holmes KK. 1999. Erythromycin-resistant *Neisseria gonorrhoeae* and oral commensal *Neisseria* spp. carry known rRNA methylase genes. *Antimicrob Agents Chemother.* 43:1367-1372.
239. Rokbi B, Maitre-Wilmotte G, Mazarin V, Fourrichon L, Lissolo L, Quentin-Millet MJ. 1995. Variable sequences in a mosaic-like domain of meningococcal Tbp2 encode immunoreactive epitopes. *FEMS Microbiol Lett.* 132:277–283.

240. Ropp PA, Nicholas RA. 1997. Cloning and characterization of the *ponA* gene encoding penicillin-binding protein 1 from *Neisseria gonorrhoeae* and *Neisseria meningitidis*. *J Bacteriol.* 179:2783-2787.
241. Ropp PA, Hu M, Olesky M, Nicholas RA. 2002. Mutations in *ponA*, the gene encoding penicillin-binding protein 1, and a novel locus, *penC*, are required for high-level chromosomally mediated penicillin resistance in *Neisseria gonorrhoeae*. *Antimicrob Agents Chemother.* 46:769-777.
242. Sandström EG, Danielsson D. 1980. Serology of *Neisseria gonorrhoeae*. Classification by co-agglutination. *Acta Pathol Microbiol Scand B.* 88:27-38.
243. Sandström EG, Chen KCS, and Buchanan TM. 1982. Serology of *Neisseria gonorrhoeae*: Coagglutination serogroups WI and WII/WIII correspond to different outer membrane protein I molecules. *Infect Immun.* 38:462-470.
244. Sandström EG, Knapp JS, Reller LB, Thompson SE, Hook EW 3rd, Holmes KK. 1984. Serogrouping of *Neisseria gonorrhoeae*: correlation of serogroup with disseminated gonococcal infection. *Sex Transm Dis.* 11:77-80.
245. Sarafian SK, Knapp JS. 1989. Molecular epidemiology of gonorrhea. *Clin Microbiol Rev.* 2 (Suppl):S49-55.
246. Scharbaai-Vázquez R, Candelas T, Torres-Bauzá LJ. 2007. Mobilization of the gonococcal 5.2 kb beta-lactamase plasmid pSJ5.2 into *Escherichia coli* by cointegration with several gram-conjugative plasmids. *Plasmid.* 57:156-164.
247. Scudamore RA, Beveridge TJ, Goldner M. 1979. Penetrability of the outer membrane of *Neisseria gonorrhoeae* in relation to acquired resistance to penicillin and other antibiotics. *Antimicrob Agents Chemother.* 15:820-827.
248. Selander RK, Caugant DA, Ochman H, Musser JM, Gilmour MN, Whittam TS. 1986. Methods of multilocus enzyme electrophoresis for bacterial population genetics and systematics. *Appl Environ Microbiol.* 51:873-884.
249. Sexual Health Society of Victoria. 2008. National Management Guidelines for Sexually Transmitted Infections 7<sup>th</sup> edition. Sexual Health Society of Victoria, Melbourne, Australia.
250. Shafer WM, Balthazar JT, Hagman KE, Morse SA. 1995. Missense mutations that alter the DNA-binding domain of the MtrR protein occur frequently in rectal isolates of *Neisseria gonorrhoeae* that are resistant to faecal lipids. *Microbiol.* 141(Pt 4):907-911.
251. Shambrook J, Russel DW. 2001. Chapter 5 Volume 1 Gel electrophoresis of DNA and pulsed-field agarose gel electrophoresis. In Shambrook J and Russel DW edited, *Molecular Cloning – a laboratory manual*, 3<sup>rd</sup> edition. Cold Spring Harbor Laboratory Press, Cold Spring Harbor, New York, USA.
252. Shannon RG, Cohen MS. 2004. The role of sexually transmitted diseases in HIV transmission. *Nat Rev Microbiol.* 2:33-42.
253. Shao C, Xu W, Ye G. 1996. Sexually transmitted disease control in China (1949-1994). *Chin Med Sci J.* 11:252-257.

254. Shigemura K, Shirakawa T, Massi N, Tanaka K, Arakawa S, Gotoh A, Fujisawa M. 2005. Presence of a mutation in *ponA1* of *Neisseria gonorrhoeae* in numerous clinical samples resistant to various beta-lactams and other, structurally unrelated, antimicrobials. *J Infect Chemother.* 11:226-230.
255. Shinnors EN, Catlin BW. 1988. *Neisseria gonorrhoeae* recombinant strains expressing hybrid serological reactivities of outer membrane proteins IA and IB. *J Infect Dis.* 58:529-536.
256. Simons MP, Nauseef WM, Apicella MA. 2005. Interactions of *Neisseria gonorrhoeae* with adherent polymorphonuclear leukocytes. *Infect Immun.* 73:1971-1977.
257. Smith NH, Maynard Smith J, Spratt BG. 1995. Sequence evolution of the *porB* gene of *Neisseria gonorrhoeae* and *Neisseria meningitidis*: evidence of positive Darwinian selection. *Mol Biol Evol.* 12:363-370.
258. Smith A, Pennefather PM, Kaye SB, Hart CA. 2001. Fluoroquinolones: place in ocular therapy. *Drugs.* 61:747-761.
259. Sor F. 1988. A complete program allows the separation of a wide range of chromosome sizes by pulse field gel electrophoresis. *Nucl Acids Res.* 16:4853-4863.
260. Sosa J, Ramirez-Arcos S, Ruben M, Li H, Llanes R, Llop A, and Dillon JR. 2003. High percentages of resistance to tetracycline and penicillin and reduced susceptibility to azithromycin characterize the majority of strain types of *Neisseria gonorrhoeae* isolates in Cuba, 1995-1998. *Sex Transm Dis.* 30:443-448.
261. Sparling PF. 1999. Biology of *Neisseria gonorrhoeae*, p. 433–449. In K. K. Holmes, P.-A. Mardh, P. F. Sparling, S. M. Lemon, W. E. Stamm, P. Piot, and J. N. Wasserheit (ed.), *Sexually transmitted diseases*, 3rd ed. McGraw-Hill, New York, N.Y.
262. Sparling PF, Tsai J, Cornelissen CN. 1999. Gonococci are survivors. *Scand J Infect Dis Suppl.* 69:125-136.
263. Spratt BG. 1988. Hybrid penicillin-binding proteins in penicillin-resistant strains of *Neisseria gonorrhoeae*. *Nature.* 332:173-176.
264. Spratt BG, Cromie KD. 1988. Penicillin-binding proteins of gram-negative bacteria. *Rev Infect Dis.* 10:699-711.
265. Starnino S, Suligoi B, Regine V, Bilek N, Stefanelli P; *Neisseria gonorrhoeae* Italian Study Group, Dal Conte I, Flanchino B, Delmonte S, Robbiano F, D'Antuono A, Mirone E, Matteelli A, De Francesco MA, Cusini M, Scioccati L, Di Carlo A, Prignano G, Salfa MC. 2008. Phenotypic and genotypic characterization of *Neisseria gonorrhoeae* in parts of Italy: detection of a multiresistant cluster circulating in a heterosexual network. *Clin Microbiol Infect.* 14:949-954.
266. Starnino S, Dal Conte I, Matteelli A, Galluppi E, Cusini M, Di Carlo A, Delmonte S, Stefanelli P. 2010. Trend of ciprofloxacin resistance in *Neisseria gonorrhoeae* strains isolated in Italy and analysis of the molecular determinants. *Diagn Microbiol Infect Dis.* 67:350-354.

267. Swartley JS, McAllister CF, Hajjeh RA, Heinrich DW, Stephens DS. 1993. Deletions of Tn916-like transposons are implicated in *tetM*-mediated resistance in pathogenic *Neisseria*. *Mol Microbiol*. 10:299–310.
268. Su X, Lind I. 2001. Molecular basis of high-level ciprofloxacin resistance in *Neisseria gonorrhoeae* strains isolated in Denmark from 1995 to 1998. *Antimicrob Agents Chemother*. 45:117-123
269. Su X, Jiang F, Qimuge, Dai X, Sun H, Ye S. 2007. Surveillance of antimicrobial susceptibilities in *Neisseria gonorrhoeae* in Nanjing, China, 1999-2006. *Sex Transm Dis*. 34:995-999.
270. Swanston WH, Ali C, Mahabir BS, Prabhakar P, Basraj S, George J. 1997. Antibiotic susceptibility of *Neisseria gonorrhoeae* in Trinidad and Tobago. *West Indian Med J*. 46:107-110.
271. Swofford DL. 2002. PAUP\*: Phylogenetic Analysis Using Parsimony (\*and other methods). Version 4.0b10. Sunderland, Massachusetts: Sinauer Associates.
272. Takahata S, Senju N, Osaki Y, Yoshida T, Ida T. 2006. Amino acid substitutions in mosaic penicillin-binding protein 2 associated with reduced susceptibility to cefixime in clinical isolates of *Neisseria gonorrhoeae*. *Antimicrob Agents Chemother*. 50:3638-3645.
273. Tam MR, Buchanan TM, Sandström EG, Holmes KK, Knapp JS, Siadak AW, Nowinski RC. 1982. Serological classification of *Neisseria gonorrhoeae* with monoclonal antibodies. *Infect Immun*. 36:1042-1053.
274. Tanaka M, Nakayama H, Haraoka M, Saika T. 2000a. Antimicrobial resistance of *Neisseria gonorrhoeae* and high prevalence of ciprofloxacin-resistant isolates in Japan, 1993 to 1998. *J Clin Microbiol*. 38:521-525.
275. Tanaka M, Nakayama H, Haraoka M, Saika T, Kobayashi I, Naito S. 2000b. Susceptibilities of *Neisseria gonorrhoeae* isolates containing amino acid substitutions in GyrA, with or without substitutions in ParC, to newer fluoroquinolones and other antibiotics. *Antimicrob Agents Chemother*. 44:192-195.
276. Tanaka M, Nakayama H, Notomi T, Irie S, Tsunoda Y, Okadome A, Saika T, Kobayashi I. 2004. Antimicrobial resistance of *Neisseria gonorrhoeae* in Japan, 1993-2002: continuous increasing of ciprofloxacin-resistant isolates. *Int J Antimicrob Agents*. 24 Suppl 1:S15-22.
277. Tanaka M, Nakayama H, Huruya K, Konomi I, Irie S, Kanayama A, Saika T, Kobayashi I. 2006. Analysis of mutations within multiple genes associated with resistance in a clinical isolate of *Neisseria gonorrhoeae* with reduced ceftriaxone susceptibility that shows a multidrug-resistant phenotype. *Int J Antimicrob Agents*. 27:20-26.
278. Tapsall JW. 2002. Current concepts in the management of gonorrhoea. *Expert Opin Pharmacother*. 3:147-157.
279. Tapsall JW. 2005. Antibiotic resistance in *Neisseria gonorrhoeae*. *Clin Infect Dis*. 41 (Suppl 4):S263-268.

280. Tapsall JW. 2006. Antibiotic resistance in *Neisseria gonorrhoeae* is diminishing available treatment options for gonorrhoea: some possible remedies. *Expert Rev Anti Infect Ther.* 4:619-628.
281. Tapsall JW. 2009a. Implications of current recommendations for third-generation cephalosporin use in the WHO Western Pacific Region following the emergence of multiresistant gonococci. *Sex Transm Infect.* 85:256-256.
282. Tapsall JW. 2009b. *Neisseria gonorrhoeae* and emerging resistance to extended spectrum cephalosporins. *Curr Opin Infect Dis.* 22:87-91.
283. Tapsall JW, Phillips EA, Shultz TR, Way B, Withnall K. 1992. Strain characteristics and antibiotic susceptibility of isolates of *Neisseria gonorrhoeae* causing disseminated gonococcal infection in Australia. Members of the Australian Gonococcal Surveillance Programme. *Int J STD AIDS.* 3:273-277.
284. Tapsall JW, Limnios EA, Shultz TR. 1998. Continuing evolution of the pattern of quinolone resistance in *Neisseria gonorrhoeae* isolated in Sydney, Australia. *Sex Transm Dis.* 25:415-417.
285. Tapsall JW, Limnios EA, Murphy D; Australian Gonococcal Surveillance Programme. 2008. Analysis of trends in antimicrobial resistance in *Neisseria gonorrhoeae* isolated in Australia, 1997-2006. *J Antimicrob Chemother.* 61:150-155.
286. Tapsall JW, Read P, Carmody C, Bourne C, Ray S, Limnios A, Sloots T, Whiley D. 2009. Two cases of failed ceftriaxone treatment in pharyngeal gonorrhoea verified by molecular microbiological methods. *J Med Microbiol.* 58(Pt 5):683-687.
287. Tazi L, Pérez-Losada M, Gu W, Yang Y, Xue L, Crandall KA, Viscidi RP. 2010. Population dynamics of *Neisseria gonorrhoeae* in Shanghai, China: a comparative study. *BMC Infect Dis.* 10:13.
288. Thompson JD, Gibson TJ, Plewniak F, Jeanmougin F, Higgins DG. 1997. The CLUSTAL\_X windows interface: flexible strategies for multiple sequence alignment aided by quality analysis tools. *Nucleic Acids Res.* 25:4876-4882.
289. Trees DL, Sandul AL, Whittington WL, Knapp JS. 1998. Identification of novel mutation patterns in the parC gene of ciprofloxacin-resistant isolates of *Neisseria gonorrhoeae*. *Antimicrob Agents Chemother.* 42:2103-2105.
290. Trees DL, Sandul AL, Peto-Mesola V, Aplasca MR, Leng HB, Whittington WL, Knapp JS. 1999. Alterations within the quinolone resistance-determining regions of GyrA and ParC of *Neisseria gonorrhoeae* isolated in the Far East and the United States. *Int J Antimicrob Agents.* 12:325-332.
291. Trees DL, Schultz AJ, Knapp JS. 2000. Use of the neisserial lipoprotein (Lip) for subtyping *Neisseria gonorrhoeae*. *J Clin Microbiol.* 38:2914-2916.
292. Tzanakaki G, Mavrommati L, Tzelepi E *et al.* 1989. Serological classification in relation to auxotypes, plasmid contents, and susceptibilities to antimicrobials of PPNG and non-PPNG strains isolated in Greece. *Genitourin Med.* 65:171-176.



293. Tzelepi E, Daniilidou M, Miriagou V, Siatravani E, Pavlidou E, Fliemetakis A. 2008. Cluster of multidrug-resistant *Neisseria gonorrhoeae* with reduced susceptibility to the newer cephalosporins in Northern Greece. *J Antimicrob Chemother.* 62:637-639.
294. Unemo M, Dillon JR. 2011. Review and recommendation of methods for typing *Neisseria gonorrhoeae* isolates and their implications for improved knowledge of gonococcal epidemiology, treatment and biology. *Clin Microbiol Rev.* 24(3): In press as of June 12, 2011.
295. Unemo M, Olcén P, Berglund T, Albert J, Fredlund H. 2002. Molecular epidemiology of *Neisseria gonorrhoeae*: sequence analysis of the *porB* gene confirms presence of two circulating strains. *J Clin Microbiol.* 40:3741-3749.
296. Unemo M, Olcen P, Albert J, Fredlund H. 2003. Comparison of serologic and genetic *porB*-based typing of *Neisseria gonorrhoeae*: consequences for future characterization. *J Clin Microbiol.* 41:4141-4147.
297. Unemo M, Olcén P, Jonasson J, Fredlund H. 2004. Molecular typing of *Neisseria gonorrhoeae* isolates by pyrosequencing of highly polymorphic segments of the *porB* gene. *J Clin Microbiol* 42:2926-2934.
298. Unemo M, Sjöstrand A, Akhras M, Gharizadeh B, Lindbäck E, Pourmand N, Wretling B, Fredlund H. 2007a. Molecular characterization of *Neisseria gonorrhoeae* identifies transmission and resistance of one ciprofloxacin-resistant strain. *APMIS* 115:231-241.
299. Unemo M, Vorobieva V, Firsova N, Ababkova T, Leniv I, Haldorsen B, Fredlund H, Skogen V. 2007b. *Neisseria gonorrhoeae* population in Arkhangelsk, Russia: phenotypic and genotypic heterogeneity. *Clin Microbiol Infect.* 13:873-878.
300. Ury HK, Fleiss JL. 1980. On approximate sample sizes for comparing two independent propositions with the use of Yates correction. *Biometrics.* 36:347-351.
301. van den Hoek A, Yuliang F, Dukers NH, Zhiheng C, Jiangting F, Lina Z, Xiuxing Z. 2001. High prevalence of syphilis and other sexually transmitted diseases among sex workers in China: potential for fast spread of HIV. *AIDS.* 15:753-759.
302. van der Ley P, Heckels JE, Virji M, Hoogerhout P, Poolman JT. 1991. Topology of outer membrane porins in pathogenic *Neisseria spp.* *Infect Immun.* 59:2963-2971.
303. van Looveren M, Ison CA, Ieven M, Vandamme P, Martin IM, Vermeulen K, Renton A, Goossens H. 1999. Evaluation of the discriminatory power of typing methods for *Neisseria gonorrhoeae*. *J Clin Microbiol.* 37:2183-2188.
304. Vázquez JA, Martín E, Galarza P, Giménez MJ, Aguilar L, Coronel P. 2007. In vitro susceptibility of Spanish isolates of *Neisseria gonorrhoeae* to cefditoren and five other antimicrobial agents. *Int J Antimicrob Agents.* 29:473-474.
305. Vidovic S, Horsman G, Dillon JR. 2010. Novel Gonococcal Multilocus Sequencing Typing (MLST) Scheme Suitable for Short and Long-Term Molecular Epidemiology Studies. Oral Presentation. The 17th International Conference of Pathogenic *Neisseria*, 11-16 September 2010, Banff, Canada.

306. Viscidi RP, Demma JC. 2003. Genetic diversity of *Neisseria gonorrhoeae* housekeeping genes. *J Clin Microbiol.* 41:197-204.
307. Viscidi RP, Demma JC, Gu J, Zenilman J. 2000. Comparison of sequencing of the *por* gene and typing of the *opa* gene for discrimination of *Neisseria gonorrhoeae* strains from sexual contacts. *J Clin Microbiol.* 38:4430-4438.
308. Walsh C. 2003. Antibiotics: actions, origins and resistance. ASM Press. American Society for Microbiology. 1752 N Street, N.W., Washington, DC 20036-2904, USA.
309. Wang Q, Zhang G. 2007. [Guidelines for diagnosis and treatment of sexually transmitted diseases 2007]. Center for Control of Sexually Transmitted Diseases, Center for Disease Control, China (China CDC). Shanghai Sciences and Technology Publishing, QinZhou Road (S), Shanghai, China 200235.
310. Wang SA, Lee MV, O'Connor N, Iverson CJ, Ohye RG, Whiticar PM, Hale JA, Trees DL, Knapp JS, Effler PV, Weinstock HS. 2003. Multidrug-resistant *Neisseria gonorrhoeae* with decreased susceptibility to cefixime-Hawaii, 2001. *Clin Infect Dis.* 37:849-852.
311. Wang M, Guo Q, Xu X, Wang X, Ye X, Wu S, Hooper DC, Wang M. 2009. New plasmid-mediated quinolone resistance gene, *qnrC*, found in a clinical isolate of *Proteus mirabilis*. *Antimicrob Agents Chemother.* 53:1892-1897.
312. Ward H. 2007. Prevention strategies for sexually transmitted infections: importance of sexual network structure and epidemic phase. *Sex Transm Infect.* 83:i43-i49.
313. Ward H, Ison C, Day S, Martin I, Ghani A, Garnett G, Bell G, Kinghorn G, Weber J. 2000. A prospective social and molecular investigation of gonococcal transmission. *Lancet.* 356:1812-1817.
314. Ward H, Rönn M. 2010. Contribution of sexually transmitted infections to the sexual transmission of HIV. *Curr Opin HIV AIDS.* 5:305-310.
315. Wasserheit JN. 1992. Epidemiological synergy. Interrelationships between human immunodeficiency virus infection and other sexually transmitted diseases. *Sex Transm Dis.* 19:61-77.
316. Waxman DJ, Strominger JL. 1983. Penicillin-binding proteins and the mechanism of action of beta-lactam antibiotics. *Annu Rev Biochem.* 52:825-869.
317. Whiley DM, Limnios EA, Ray S, Sloots TP, Tapsall JW. 2007a. Diversity of *penA* alterations and subtypes in *Neisseria gonorrhoeae* strains from Sydney, Australia, that are less susceptible to ceftriaxone. *Antimicrob Agents Chemother.* 51:3111-3116.
318. Whiley DM, Limnios EA, Ray S, Sloots TP, Tapsall JW. 2007b. Further questions regarding the role of mosaic *penA* sequences in conferring reduced susceptibility to ceftriaxone in *Neisseria gonorrhoeae*. *Antimicrob Agents Chemother.* 51:802-803.
319. Whiley DM, Goire N, Lambert SB, Ray S, Limnios EA, Nissen MD, Sloots TP, Tapsall JW. 2010. Reduced susceptibility to ceftriaxone in *Neisseria gonorrhoeae* is associated with mutations G542S, P551S and P551L in the gonococcal penicillin-binding protein 2. *J Antimicrob Chemother.* 65:1615-1618.

320. WHO (World Health Organization). 1989. STD Treatment Strategies. WHO/VDT/89.447. 1989 pp30.
321. WHO (World Health Organization). 2001a. Global prevalence and incidence of selected curable sexually transmitted infections: overview and estimates. WHO/HIV\_AIDS/2001.02 and WHO/CDS/CSR/EDC/2001.10
322. WHO (World Health Organization). 2001b. Antimicrobial resistance in *Neisseria gonorrhoeae*. WHO/CDS/CSR/DRS/2001.3.
323. WHO (World Health Organization). 2003. Guidelines for the management of sexually transmitted infections. World Health Organization. Geneva, Switzerland.
324. WHO (World Health Organization). 2007. Global strategy for the prevention and control of sexually transmitted infections 2006–2015- breaking the chain of transmission. World Health Organization, Geneva, Switzerland.
325. WHO (World Health Organization). 2010. Communicable Disease Global Atlas (Last accessed August 10, 2010; <http://www.who.int/globalatlas/DataQuery/default.asp>)
326. WHO (World Health Organization). 2011. Global prevalence and incidence of selected curable sexually transmitted infections: overview and estimates. World Health Organization, Geneva, Switzerland. In press.
327. WHO-WPR (World Health Organization Western Pacific, Gonococcal Antimicrobial Surveillance Programme). 1997a. Surveillance of antibiotic resistance in *Neisseria gonorrhoeae* in the WHO Western Pacific Region, 1996. *Commun Dis Intell.* 21:349-353.
328. WHO-WPR (World Health Organization Western Pacific, Gonococcal Antimicrobial Surveillance Programme). 1997b. Surveillance of antibiotic susceptibility of *Neisseria gonorrhoeae* in the WHO Western Pacific region, 1992-1994. *Genitourin Med.* 73:355-361.
329. WHO-WPR (World Health Organization Western Pacific, Gonococcal Antimicrobial Surveillance Programme). 1998. Resistance in gonococci isolated in the WHO Western Pacific Region to various antimicrobials used in the treatment of gonorrhoea, 1997. *Commun Dis Intell.* 22:288-291.
330. WHO-WPR (World Health Organization Western Pacific, Gonococcal Antimicrobial Surveillance Programme). 2000a. Surveillance of antibiotic resistance in *Neisseria gonorrhoeae* in the WHO Western Pacific Region, 1998. *Commun Dis Intell.* 24:1-4.
331. WHO-WPR (World Health Organization Western Pacific, Gonococcal Antimicrobial Surveillance Programme). 2000b. Surveillance of antibiotic resistance in *Neisseria gonorrhoeae* in the WHO Western Pacific Region, 1999. *Commun Dis Intell.* 24:269-271.
332. WHO-WPR (World Health Organization Western Pacific, Gonococcal Antimicrobial Surveillance Programme). 2001. Surveillance of antibiotic resistance in *Neisseria gonorrhoeae* in the WHO Western Pacific Region, 2000. *Commun Dis Intell.* 25: 274-276.
333. WHO-WPR (World Health Organization Western Pacific, Gonococcal Antimicrobial Surveillance Programme). 2002. Surveillance of antibiotic resistance in *Neisseria gonorrhoeae* in the WHO Western Pacific Region, 2001. *Commun Dis Intell.* 26:541-545.

334. WHO-WPR (World Health Organization Western Pacific, Gonococcal Antimicrobial Surveillance Programme). 2003. Surveillance of antibiotic resistance in *Neisseria gonorrhoeae* in the WHO Western Pacific Region, 2002. *Commun Dis Intell.* 27: 488-491.
335. WHO-WPR (World Health Organization Western Pacific, Gonococcal Antimicrobial Surveillance Programme). 2005. Surveillance of antibiotic resistance in *Neisseria gonorrhoeae* in the WHO Western Pacific Region, 2003. *Commun Dis Intell.* 29:62-64.
336. WHO-WPR (World Health Organization Western Pacific, Gonococcal Antimicrobial Surveillance Programme). 2006a. Surveillance of antibiotic resistance in *Neisseria gonorrhoeae* in the WHO Western Pacific Region, 2004. *Commun Dis Intell.* 30:129-132.
337. WHO-WPR (World Health Organization Western Pacific, Gonococcal Antimicrobial Surveillance Programme). 2006b. Surveillance of antibiotic resistance in *Neisseria gonorrhoeae* in the WHO Western Pacific Region, 2005. *Commun Dis Intell.* 30:430-433.
338. WHO-WPR (World Health Organization Western Pacific, Gonococcal Antimicrobial Surveillance Programme). 2008. Surveillance of antibiotic resistance in *Neisseria gonorrhoeae* in the WHO Western Pacific Region, 2006. *Commun Dis Intell.* 32:48-51.
339. WHO-WPR (World Health Organization Western Pacific, Gonococcal Antimicrobial Surveillance Programme). 2010. Surveillance of antibiotic resistance in *Neisseria gonorrhoeae* in the WHO Western Pacific and South East Asian regions, 2007-2008. *Commun Dis Intell.* 34:1-7.
340. Woods JP, Spinola SM, Strobel SM, Cannon JG. 1989. Conserved lipoprotein H.8 of pathogenic *Neisseria* consists entirely of pentapeptide repeats. *Mol Microbiol.* 3:43-48.
341. Workowski KA, Berman SM, Douglas JM Jr. 2008. Emerging antimicrobial resistance in *Neisseria gonorrhoeae*: urgent need to strengthen prevention strategies. *Ann Intern Med.* 148:606-613.
342. Wylie JL, Cabral T, Jolly AM. 2005. Identification of networks of sexually transmitted infection: a molecular, geographic, and social network analysis. *J Infect Dis.* 191: 899-906.
343. Wylie JL, Jolly A. 2001. Patterns of chlamydia and gonorrhea infection in sexual networks in Manitoba, Canada. *Sex Transm Dis.* 28:14-24.
344. Xia MS, Pang YJ, Roberts MC. 1995. Detection of two groups of 25.2 MDa tet M plasmids by polymerase chain reaction of the downstream region. *Mol Cell Probes.* 9:327-332.
345. Yang Y, Liao M, Gu WM, Bell K, Wu L, Eng NF, Zhang CG, Chen Y, Jolly AM, Dillon JR. 2006. Antimicrobial susceptibility and molecular determinants of quinolone resistance in *Neisseria gonorrhoeae* isolates from Shanghai. *J Antimicrob Chemother.* 58:868-872.
346. Yates F. 1934. Contingency tables involving small numbers and the  $X^2$  test. *J Royal Stat Soc.* 1:217-235.
347. Ye SZ. 1994. Survey on antibiotic sensitivity of *Neisseria gonorrhoeae* strains isolated in China, 1987-1992. *Sex Transm Dis.* 21:237-240.

348. Ye SZ, Su X, Wang Q, Yin Y, Dai X, Sun H. 2002. Surveillance of antibiotic resistance of *Neisseria gonorrhoeae* isolates in China, 1993-1998. *Sex Transm Dis.* 29:242-245.
349. Ye SZ, Wang QQ, Su XH, Yin YP, Dai XQ, Sun HH. 2003. [Epidemiological and bacteriological characteristics of *Neisseria gonorrhoeae* isolates in China.] *Zhonghua Liu Xing Bing Xue Za Zhi.* 24:119-122.
350. Ye SZ, Su X, Wang Q. 2004. [Fifteen year monitoring of drug resistance of gonococci.] *Chinese J. Human Sexuality.* 13:1-3.
351. Yeung KH, Dillon JR. 1988. Construction of miniplasmids from the 7.2-kb and 5.1-kb penicillinase-producing plasmids of *Neisseria gonorrhoeae* reveals two replication regions. *Plasmid.* 20:232-240.
352. Yeung KH, Dillon JR, Pauzé M, Wallace E. 1986. A novel 4.9-kilobase plasmid associated with an outbreak of penicillinase-producing *Neisseria gonorrhoeae*. *J Infect Dis.* 153:1162-1165.
353. Yeung KH, Dillon JR, and the National Study Group. 1990. Cases of *N. gonorrhoeae* with plasmid-mediated resistance to penicillin increase. *Can. Dis. Wkly. Rep.* 16-3:13-16.
354. Yeung KH, Pauze M, Dillon JR. 1991. Status of penicillinase-producing *Neisseria gonorrhoeae* in Canada-1989. *Can Dis Weekly Rep.* 17:49-50.
355. Yi YP. 2007 [Guidelines for laboratory diagnosis of sexually transmitted diseases]. Shanghai Science & Technology Publisher, Shanghai, China.
356. Yokoi S, Deguchi T, Ozawa T, Yasuda M, Ito S, Kubota Y, Tamaki M, Maeda S. 2007. Threat to cefixime treatment for gonorrhea. *Emerg Infect Dis.* 13:1275-1277.
357. Yorke JA, Hethcote HW, Nold A. 1978. Dynamics and control of the transmission of gonorrhoea. *Sex Transm Dis.* 5:51-56.
358. Zapun A, Contreras-Martel C, Vernet T. 2008. Penicillin-binding proteins and beta-lactam resistance. *FEMS Microbiol Rev.* 32:361-385.
359. Zarantonelli L, Borthagaray G, Lee EH, Shafer WM. 1999. Decreased azithromycin susceptibility of *Neisseria gonorrhoeae* due to *mtrR* mutations. *Antimicrob Agents Chemother.* 43:2468-2472.
360. Zhao S, Duncan M, Tomberg J, Davies C, Unemo M, Nicholas RA. 2009. Genetics of chromosomally mediated intermediate resistance to ceftriaxone and cefixime in *Neisseria gonorrhoeae*. *Antimicrob Agents Chemother.* 53:3744-3751.

## **APPENDIX**

## A1 Questionnaire for Patient Recruitment of Male Gonorrhoea Patients

*To interviewer; by sex or sexual intercourse we mean oral, vaginal or anal sex. Frottage (rubbing together) or mutual masturbation without insertion do not usually transmit STI and hence we do not ask questions about them. Also, sex includes all sex within a love relationship and within a trade relationship.*

### 1.0 Administration

**ADMIN1** Client ID number \_\_\_\_\_

**ADMIN2** Interviewer's name \_\_\_\_\_

ADMIN3	Centre	Shanghai	9
		ChengDu	9
		Urumqi	9

Date of interview: \_\_\_\_ / \_\_\_\_ / \_\_\_\_  
Day/month/year

**DEM1** What is the highest level of education you have received?

1.	No school	9
2.	Below primary school	9
3.	Primary school	9
4.	Middle school	9
5.	High school	9
6.	Above High School	9

**DEM2** How much money did you earn in the last three months on average?

\_\_\_\_\_

**DEM3** What kind of work do you do most often? Mark 1 for the work done most often in the past three months

1.	Public servant	9
2.	Company manager or owner	9
3.	Commercial representatives (sales representatives)	9
4.	Workers (manual labourers, including migrants)	9
5.	Student	<input type="checkbox"/>
6.	Taxi; truck, company driver	<input type="checkbox"/>
7.	Waiters	<input type="checkbox"/>
8.	Teachers, professors and health professionals	<input type="checkbox"/>
9.	Farmers	<input type="checkbox"/>

- |     |                                      |   |
|-----|--------------------------------------|---|
| 10. | Army personnel                       | □ |
| 11. | No job                               | 9 |
| 12. | Small business/store manager, owner. | 9 |
| 13. | Retired                              | 9 |
| 14. | Company staff                        | 9 |
| 15. | Other                                | 9 |
- 

**DEM4** Who are you living with now? Mark only one.

- |    |  |   |
|----|--|---|
| 1. | Alone  | 9 |
| 2. | Girlfriend   | 9 |
| 3. | Girlfriend with whom you have lived for longer than one year | 9 |
| 4. | Wife   | 9 |
| 5. | Parent   | 9 |
| 6. | Room mate, share   | 9 |
| 5. | Other, specify:  | 9 |
- 

**DEM5** Does your house have...? for ChengDu and Urumqi

- |    |                          |   |
|----|--------------------------|---|
| 1. | Running water from a tap | 9 |
| 2. | Television               | 9 |
| 3. | Cell phone               | 9 |

**DEM6** Do you have any religious beliefs?

- |    |      |   |                |
|----|------|---|----------------|
| 1. | Yes  | 9 | Specify; _____ |
| 2. | None | 9 |                |

**HIST** **STI history**

**HIST1** Did you experience any symptoms from your current STD now? **Read from list below.**

**If HIST1 is No go to question HIST5,**

9Yes                      9No                      9Unsure                      9 Refuse

**HIST2** Mark all which apply (Read from list:)

- |    |                                     |   |
|----|-------------------------------------|---|
| 1. | Redness at tip of penis             | 9 |
| 2. | Discharge from penis                | 9 |
| 3. | Pain or burning on passing urine    | 9 |
| 4. | Swelling or pain of testicles/balls | 9 |
| 5. | Itching of genitals                 | 9 |
| 6. | Other, specify _____                |   |



**HIST3** When did the symptoms begin?

\_\_\_ \_\_\_ / \_\_\_ \_\_\_ / \_\_\_ \_\_\_ \_\_\_ \_\_\_  
Day/month/year

**HIST4** Did you have sex while you had symptoms?

9Yes                      9No                      9Unsure                      9Refused

**HIST5** When you were diagnosed with this STI now, why did you go to see the doctor or nurse? Check the most important reason only.

- |   |  |   |
|---|--|---|
| 1 | Symptoms                                 | 9 |
| 2 | Contact of case                          | 9 |
| 3 | For a check-up in case you had risky sex | 9 |
| 4 | Other, specify                           |   |
- 

**HIST6.** What treatment did you have for the current STI now? Mark **all** which apply. If unsure write the name of the drug(s)

- |     |                 |   |
|-----|-----------------|---|
| 1.  | Penicillins     | 9 |
| 2.  | Cephalosporins  | 9 |
| 3.  | Aminoglycosides | 9 |
| 4.  | Tetracyclines   | 9 |
| 5.  | Macrolides      | 9 |
| 6.  | Quinolones      | 9 |
| 7.  | Sulfonamides    | 9 |
| 8.  | Azathioprine    | 9 |
| 9.  | Antifungals     | 9 |
| 10. | Other, specify  |   |
- 

**HIST7** How many days did you take the current treatment?

Mark number of days \_\_\_\_\_

**HIST8** Just before you got the current STI, where did you meet the sex partner(s)? The one immediately before you came here?

- |    |                                   |   |
|----|-----------------------------------|---|
| 1. | This city. Specify district _____ |   |
| 2. | Mainland China                    | 9 |
|    | Specify province, city: _____     |   |
| 3. | Taiwan, Hong Kong                 | 9 |
| 4. | Other country                     |   |

Specify: \_\_\_\_\_

**HIST9** Have you ever had an STI before?

**If No then go to PRACT1**

9Yes

9No

9Unsure

9Refused

If **HIST9** is yes, then

**HIST10** which ones in the past 12 months? Mark all that are applicable, and how many times.

- |    |                          |   |                    |
|----|--------------------------|---|--------------------|
| 1. | Syphilis                 | 9 | how much time_____ |
| 2. | Gonorrhea                | 9 | how much time_____ |
| 3. | Chlamydia                | 9 | how much time_____ |
| 4. | Condyloma, genital warts | 9 | how much time_____ |
| 5. | Herpes                   | 9 | how much time_____ |
| 6. | HIV/AIDS                 | 9 | how much time_____ |
| 7. | Mycoplasma               | 9 | how much time_____ |
| 8. | Other, specify_____      |   |                    |

**HIST11** When was the last time you had an STI?

/\_\_ \_\_/ \_\_ \_\_ \_\_ \_\_  
/month/year

**HIST12** Where did you see a doctor for the previous STI? Not the current one.

- |    |                               |   |
|----|-------------------------------|---|
| 1. | Public or government hospital | 9 |
| 2. | Private hospital              | 9 |
| 3. | Private practitioner          | 9 |
| 4. | Self-diagnosed                | 9 |

**HIST13** Which drug did you have for the previous STI? Mark all of which apply.

- |    |                                |   |
|----|--------------------------------|---|
| 1. | Oral                           | 9 |
| 2. | Injection                      | 9 |
| 3. | Douche, vaginal wash           | 9 |
| 4. | Suppository (Candida albicans) | 9 |
| 5. | Ointment (external use)        | 9 |
| 6. | Laser surgery (HPV)            | 9 |
| 7. | Other                          | 9 |

**PRACT** **Health knowledge, attitudes and practice relating to sex and STI**

**PRACT1** Do you usually...? Mark all that apply

- |    |               |   |
|----|---------------|---|
| 1. | Use lubricant | 9 |
|----|---------------|---|

- |    |  |   |
|----|--|---|
| 2. | Use any topical disinfectant                                   | 9 |
| 3. | Use any topical sexual enhancer                                | 9 |
| 4. | Wash genitals before sex                                       | 9 |
| 5. | Wash genitals after sex  | 9 |
| 6. | Take regular doses of antibiotics (over the counter)           | 9 |
| 7. | Take over the counter antibiotics if you think you have an STI | 9 |
| 8. | Take over the counter of antibiotics when you have risky sex   | 9 |
| 9. | None of the above  | 9 |

**PRACT2** Are you circumcised?

9 Yes	9 No	9 Refused
-------	------	-----------

**PRACT3** Do you have sex with...? 9

- |    |                            |   |
|----|----------------------------|---|
| 1. | People of the same sex     | 9 |
| 2. | People of the opposite sex | 9 |
| 3. | Both                       | 9 |
| 4. | Refused                    | 9 |

**PRACT4** What birth control method did you use at most recent sex?

- |    |                |   |
|----|----------------|---|
| 1. | Condoms        | 9 |
| 2. | Vasectomy      | 9 |
| 3. | Withdrawal     | 9 |
| 4. | None           | 9 |
| 5. | Refused        | 9 |
| 6. | Other, specify | 9 |

**PRACT5** In the past 12 months how often have you used alcohol before or during sexual activities?

- |    |                        |   |
|----|------------------------|---|
| 1. | Always                 | 9 |
| 2. | More than 1/2 the time | 9 |
| 3. | About 1/2 the time     | 9 |
| 4. | Less than 1/2 the time | 9 |
| 5. | Never                  | 9 |
| 6. | Refused to answer      | 9 |

**PRACT6** In the past 12 months how often have you used psychogenic drugs (ones that make you high), before or during sexual activities?

- |    |                        |   |
|----|------------------------|---|
| 1. | Always                 | 9 |
| 2. | More than 1/2 the time | 9 |
| 3. | About 1/2 the time     | 9 |
| 4. | Less than 1/2 the time | 9 |

- 5. Never 9
- 6. Refused to answer 9

**Remember, all the answers you give us will remain confidential between you and me. We will use your answers only to count how many people may get STIs**

**PRACT7** In the past 12 months have you ever injected street drugs, or been injected with drugs?

- 1. Yes 9
- 2. No 9
- 3. Refused to answer 9

**PRACT8** At what age did you first voluntarily (willingly) have sex ?

- Give age 99
- Refused to answer 9

**PRACT9** In the past 3 months, how many sex partners have you had?

- Give number: 99
- Unsure 9
- Refused to answer 9

**PRACT10** In your lifetime, how many sexual partners have you had? Give your best guess.

- Give number: 99
- Unsure 9
- Refused to answer 9

**Now, we want to ask you some more personal information. Remember, we will not give this information to anyone, and we will only use it to count the number of people of what age, or which cities they are from.**

## **DEM Personal information of client**

**DEM7** Date of birth \_\_\_ \_\_\_ / \_\_\_ \_\_\_ / \_\_\_ \_\_\_ \_\_\_ \_\_\_  
Day/month/year

**DEM8** Where do you live in this city?

District \_\_\_\_\_

Refused 9

**DEM9** Are you or official permanent resident(s) of this city? (Have official registration?)  
**If DEM9 is YES then go to DEM12**  
**IF DEM9 is NO then go to DEM10**

9Yes                      9No                      9Refused

**DEM 10** Have you lived in this city longer than 6 months?

9Yes                      9No                      9Refused

**DEM11** Which Chinese province or country did you live in before this city?

1. Mainland China
2. Hong Kong, Taiwan
3. Other country or province

Specify: \_\_\_\_\_

**DEM12** What ethnic group do you belong to? (For ChengDu and Urumqi)

1. Han
2. Uigur
3. Other, specify

\_\_\_\_\_

**Section II. Sexual partner information for named partners:**

We will note the alias, initial or name of up to 10 partners with whom you had sex in the last 3, so that you can remember which partner we are talking about. Start with the sex partners with whom you had sex immediately before the onset of symptoms. Then write in the partners with whom you had sex after your symptoms started.

- 1. \_\_\_\_\_
- 2. \_\_\_\_\_
- 3. \_\_\_\_\_
- 4. \_\_\_\_\_
- 5. \_\_\_\_\_
- 6. \_\_\_\_\_
- 7. \_\_\_\_\_
- 8. \_\_\_\_\_
- 9. \_\_\_\_\_
- 10. \_\_\_\_\_

**1.0 Administration**

**ADMIN1** Index client ID number \_\_\_\_\_

**ADMIN2**

Partner's name, alias or initials (from the previous sheet)

**PARTID** \_\_\_\_\_ **PARTNO** \_\_\_\_\_

**2.0 Partner information**

**PART1** Is this partner..?  
 Male (go to PART3)  Female

**PART2** Is this partner pregnant in the past three months?

9Yes                      9No                      9Unknown

**If yes, then explain that there is a danger to her health and that of the baby. Refer to OB-GYN clinic or hospital.**

**PART3** Where is this partner originally from?

- 1. Mainland China  
Specify province: \_\_\_\_\_
- 2. Hong Kong, Taiwan

3. Other country, specify: \_\_\_\_\_

**PART4** To the best of your knowledge, what is the highest level of education this partner (#) has completed?

- |    |                      |   |
|----|----------------------|---|
| 1. | No school            | 9 |
| 2. | Below primary school | 9 |
| 3. | Primary school       | 9 |
| 4. | Middle school        | 9 |
| 5. | High school          | 9 |
| 6. | Above High School    | 9 |
| 7. | Unknown              | 9 |
| 8. | Refused              | 9 |

**PART5** To your knowledge, what was your partner's work? Mark only one.

- |     |  |   |
|-----|--|---|
| 1.  | Public servant                                     | 9 |
| 2.  | Company managers or owner                          | 9 |
| 3.  | Commercial representatives (sales representatives) | 9 |
| 4.  | Workers (manual labourers, including migrants)     | 9 |
| 5.  | Student  | 9 |
| 6.  | Taxi; truck, company driver                        | 9 |
| 7.  | Waiters, waitress                                  | 9 |
| 8.  | Teachers, professors and health professionals      | 9 |
| 9.  | Farmers  | 9 |
| 10. | Army personnel                                     | 9 |
| 11. | No job   | 9 |
| 12. | Small business/store manager, owner.               | 9 |
| 13. | Retired  | 9 |
| 14. | Company staff                                      | 9 |
| 15. | housewife  | 9 |
| 16. | Other, specify                                     | 9 |

**PART6** Where did you first meet partner (#)? mark only one

- |    |  |   |
|----|--|---|
| 1. | Through family or mutual friends   | 9 |
| 2. | At school, college or university   | 9 |
| 3. | At work  | 9 |
| 4. | Park,  | 9 |
| 5. | Bar, beauty parlour, sauna, barber shops, karaoke bars, massage parlours, foot massage parlour | 9 |
| 6. | Internet   | 9 |
| 7. | Unsure   | 9 |
| 8. | Refused  | 9 |
| 9. | Other (specify)  | 9 |

**PART7** In which place did you meet this sex partner?

- |    |   |   |
|----|---|---|
| 1. | This city<br>Specify district _____             | 9 |
| 2. | Mainland China<br>Specify province, city: _____ | 9 |
| 3. | Taiwan, Hong Kong                               | 9 |
| 4. | Other country, specify:                         | 9 |
- 

**PART8** What is your relationship to this partner?

- |    |                                     |   |
|----|-------------------------------------|---|
| 1. | Spouse                              | 9 |
| 2. | Lover                               | 9 |
| 3. | Casual/temporary sex partner unpaid | 9 |
| 4. | Casual/temporary sex partner paid   | 9 |
| 5. | Unsure                              | 9 |
| 6. | Refused to answer                   | 9 |

**PART9** How long did you know this partner before you first had sex? Mark ONE ONLY

1. Number of \_\_\_\_\_ days, OR
2. Number of \_\_\_\_\_ months, OR
3. Number of \_\_\_\_\_ years

**PART10** When did you first have sex with this partner?

\_\_\_/\_\_\_/\_\_\_\_\_  
Day/month/year

**PART11** When was the most recent time you had sex with this partner? Enter as a specific date

\_\_\_/\_\_\_/\_\_\_\_\_  
Day/month/year

**PART12** How often did you have sex with this person?

- |    |                          |   |
|----|--------------------------|---|
| 1. | Once a day or more       | 9 |
| 2. | 2-3 times per week       | 9 |
| 3. | About once per week      | 9 |
| 4. | 1-3 times per month      | 9 |
| 5. | Less than once per month | 9 |
| 6. | Only once ever           | 9 |
| 7. | Refused to answer        | 9 |



**PART13** In last session or last date; how often did you have intercourse?  
Give number of times:

\_\_\_\_\_ 9Refused

**PART14** In the past 3 months, Did you have vaginal, anal or oral sex with this person?  
**Mark all applicable with 1 for the most frequent and 3 for the least. Mark 2 if the first two are equal. Mark all with the same number if equal. Mark 0 if none**

- |    |         |   |
|----|---------|---|
| 1. | Vaginal | 9 |
| 2. | Anal    | 9 |
| 3  | Oral    | 9 |
| 4. | Refused | 9 |

**PART15** How often was a condom (either male or female condom) used with this partner in the past three months?

- |    |                        |   |
|----|------------------------|---|
| 1. | Never                  | 9 |
| 2  | Less than 1/2 the time | 9 |
| 3  | About 1/2 the time     | 9 |
| 4  | More than 1/2 the time | 9 |
| 5  | Always                 | 9 |
| 6  | Unsure                 |   |
| 7  | Refused to answer      | 9 |

**PART16** At the most recent episode of sexual intercourse with this partner, was a condom used?

9Yes                      9No                      9Refused

**PART17** To your knowledge, who else does this partner have sex with? Mark all that apply.

- |    |                                      |   |
|----|--------------------------------------|---|
| 1. | Spouse                               | 9 |
| 2. | Lover                                | 9 |
| 3. | Boyfriend                            | 9 |
| 4. | Casual /temporary sex partner unpaid | 9 |
| 5. | Temporary sex partner paid           | 9 |
| 6. | Unsure                               | 9 |
| 7. | Refused to answer                    | 9 |

**PART18** To the best of your knowledge, has this partner ever injected drugs in the last 12 months?

- |   |                   |   |
|---|-------------------|---|
| 1 | Yes               | 9 |
| 2 | No                | 9 |
| 3 | Don't know        | 9 |
| 4 | Refused to answer | 9 |

**PART19** Have you ever given this partner anything in exchange for sex?

- |    |   |   |
|----|---|---|
| 1. | Money   | 9 |
| 2. | Food, shelter, clothing or something of value | 9 |
| 3  | Drugs   | 9 |
| 4  | Never given anything                          | 9 |
| 5  | Refused to answer                             | 9 |

**PART20** Have you ever received anything from this partner in exchange for sex? (Sold sex)

- |    |   |   |
|----|---|---|
| 1. | Money   | 9 |
| 2. | Food, shelter, clothing or something of value | 9 |
| 3  | Drugs   | 9 |
| 4  | Never given anything                          | 9 |
| 5  | Refused to answer                             | 9 |

**PART21** Have you ever discussed with this partner whether or not she or he has HIV?

9Yes                      9No                      9Refused

**PART22** Have you ever discussed with this partner whether or not they have ever had an STD?

9  
Yes                      9No                      9Refused

## **A2 Citation Approvals**

### **A2.1 WHO Press (Permissions Management)**

July 29, 2010

Dear Dr Liao

Thank you for your enquiry. On behalf of the World Health Organization, we are pleased to grant you permission to reproduce the following WHO item/s, as indicated in your message below. Please note that this permission is granted under the following terms:

WHO material should not be reproduced for use in association with commercial nor promotional activities. WHO does not endorse any specific company nor products.

The WHO Logo/Emblem should not be reproduced, unless it appears on an original WHO publication or unless a specific permission is given by WHO for its use.

Please ensure that the original WHO source is appropriately acknowledged, with bibliographic reference/s and/or Web URL (site/s) if appropriate.

Please provide me an original copy of your publication for our records, showing where/how WHO material appears and how it is referenced on your product.

Thank you for your interest in WHO publications and best regards.

Ms Dolores Campanario  
WHO Press (Permissions Management)  
Knowledge Management and Sharing  
WORLD HEALTH ORGANIZATION  
20, avenue Appia, CH-1211 Geneva 27  
Switzerland  
Tel.: 0041 22 7912483  
Fax.: 0041 22 7914857

#### **INFORMATION ABOUT WHO MATERIAL TO BE REPRODUCED:**

Global Strategies for the Prevention and Control of Sexually Transmitted Infections: 2006-2015: breaking the chain of transmission. 2007 WHO. ISBN / WHO Reference Number: 9789241563475.

Item(s) to be reproduced: Figure 1. Transmission dynamics of sexually transmitted infections at the population level

## A2.2 Approval from Annals of Internal Medicine



WAA1016675

June 20, 2011

College of Arts and Science  
Vaccine and Infectious Disease Organization  
University of Saskatchewan  
A233-VIDO, 120 Veterinary Rd  
Saskatoon, Saskatchewan, Canada S7N 5E3

Dear Dr Liao:

Thank you for your request to print the following from *Annals of Internal Medicine*:

Appendix figure: Kimberly A. Workowski, et al, Emerging Antimicrobial Resistance in *Neisseria gonorrhoeae*: Urgent Need to Strengthen Prevention Strategies. *Ann Intern Med* April 15, 2008 148

Permission is granted to print the preceding material with the understanding that you will give appropriate credit to *Annals of Internal Medicine* as the original source of the material. Any translated version must carry a disclaimer stating that the American College of Physicians is not responsible for the accuracy of the translation. This permission grants non-exclusive, worldwide rights for this edition in print for not for profit only. ACP does not grant permission to reproduce entire articles or chapters on the Internet unless explicit permission is given. This letter represents the agreement between ACP and Mingmin Liao, MD, MMed, PhD candidate for request WAA1016675 and supersedes all prior terms from the requestor.

Thank you for your interest in *Annals of Internal Medicine*. If you have any further questions or would like to discuss the matter further, please contact me at 856-489-4446 or fax 856-489-4449.

Sincerely,

Gina Brown  
Permissions Coordinator

### **A2.3 Oxford University Press (Yang et al 2006, J Antimicrob Chemother)**

#### **OXFORD UNIVERSITY PRESS LICENSE TERMS AND CONDITIONS**

Sep 04, 2010

This is a License Agreement between Mingmin Liao ("You") and Oxford University Press ("Oxford University Press") provided by Copyright Clearance Center ("CCC"). The license consists of your order details, the terms and conditions provided by Oxford University Press, and the payment terms and conditions.

**All payments must be made in full to CCC. For payment instructions, please see information listed at the bottom of this form.**

License Number: 2501991197249

License date: Sep 04, 2010

Licensed content publisher: Oxford University Press

Licensed content publication: Journal of Antimicrobial Chemotherapy

Licensed content title: Antimicrobial susceptibility and molecular determinants of quinolone resistance in *Neisseria gonorrhoeae* isolates from Shanghai

Licensed content author : Yang Yang, et al. 2006.

Type of Use: Thesis/Dissertation

Permissions cost: 0.00 USD

Value added tax: 0.00 USD

Total: 0.00 USD

## A2.4 Oxford University Press (Liao et al 2008, J Antimicrob Chemother)

### OXFORD UNIVERSITY PRESS LICENSE TERMS AND CONDITIONS

Sep 04, 2010

This is a License Agreement between Mingmin Liao ("You") and Oxford University Press ("Oxford University Press") provided by Copyright Clearance Center ("CCC"). The license consists of your order details, the terms and conditions provided by Oxford University Press, and the payment terms and conditions.

**All payments must be made in full to CCC. For payment instructions, please see information listed at the bottom of this form.**

License Number: 2502000221164

License date: Sep 04, 2010

Licensed content publisher: Oxford University Press

Licensed content publication: Journal of Antimicrobial Chemotherapy

Licensed content title: Clusters of circulating *Neisseria gonorrhoeae* strains and association with antimicrobial resistance in Shanghai

Licensed content author: Mingmin Liao, et al. 2008

Type of Use: Thesis/Dissertation

Permissions cost: 0.00 USD

Value added tax: 0.00 USD

Total: 0.00 USD

## A2.5 Oxford University Press (Liao et al 2011, J Antimicrob Chemother)

---

**OXFORD**  
UNIVERSITY PRESS

Mingmin Liao  
Vaccine and Infectious Disease Organization  
University of Saskatchewan  
120 Veterinary Road  
Saskatoon, Saskatchewan  
Canada S7N 5E3

Rights Department, Oxford Journals  
Great Clarendon Street,  
Oxford OX2 6DP, UK  
Telephone: 44 [0] 1865 355123  
Fax: 44 [0] 1865 353835  
Email: [chris.payne@oup.com](mailto:chris.payne@oup.com)

Tuesday, 19 April 2011

Dear Mingmin Liao

**RE: Journal of Antimicrobial Chemotherapy. 2011 May;66(5):1016-23.**

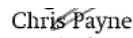
*Liao M, Gu WM, Yang Y, Dillon JA. Analysis of mutations in multiple loci of Neisseria gonorrhoeae...*

Thank you for your email requesting permission to reprint the above material. Our permission is granted without fee to reproduce the material.

Use of the above material is restricted to the reuse the results and discussion in your thesis available in print format only, to be used only in the English language. This permission is limited to this particular use and does not allow you to use it elsewhere or in any other format other than specified above.

Please include a credit line in your publication citing full details of the Oxford University Press publication which is the source of the material and by permission of Oxford University Press or the sponsoring society if this is a society journal.

If the credit line or acknowledgement in our publication indicates that material including any illustrations/figures etc was drawn or modified from an earlier source it will be necessary for you to also clear permission with the original publisher. If this permission has not been obtained, please note that this material cannot be included in your publication/photocopies.

  
Chris Payne  
Head of Copyright and Permissions

---

## A2.6 American Society of Microbiology (Liao et al 2009)

### AMERICAN SOCIETY FOR MICROBIOLOGY LICENSE TERMS AND CONDITIONS

Sep 04, 2010

This is a License Agreement between Mingmin Liao ("You") and American Society for Microbiology ("American Society for Microbiology") provided by Copyright Clearance Center ("CCC"). The license consists of your order details, the terms and conditions provided by American Society for Microbiology, and the payment terms and conditions.

**All payments must be made in full to CCC. For payment instructions, please see information listed at the bottom of this form.**

License Number; 2502000749142

License date: Sep 04, 2010

Licensed content publisher: American Society for Microbiology

Licensed content publication: Journal of Clinical Microbiology

Licensed content title: Comparison of *Neisseria gonorrhoeae* Multiantigen Sequence Typing and porB Sequence Analysis for Identification of Clusters of *N. gonorrhoeae* Isolates

Licensed content author: Mingmin Liao, Jo-Anne R. Dillon

Licensed content date: Feb 1, 2009



### A3 Mingmin Liao Curriculum Vitae

LIAO, Mingmin, M.D., M.Med, Ph.D. Candidate (Defended June 2011)  
Research Scientist, Vaccine and Infectious Disease Organization (VIDO)  
Laboratory Manager, College of Arts and Science  
University of Saskatchewan

Room A233, 120 Veterinary Road  
VIDO, Saskatoon, SK S7N 5E3; CANADA  
Tel: (306) 966-1539; Fax: (306)966-7478  
Email: mil395@mail.usask.ca

#### Language Competency:

- English: Reading, writing and speaking
- Chinese: Reading, writing and speaking

#### Education:

- Ph.D. candidate: Department of Microbiology & Immunology, University of Saskatchewan, Saskatoon, Canada (January 2007 – June 2011). Research topic: Molecular epidemiology and molecular mechanisms of antimicrobial resistance in *Neisseria gonorrhoeae* in China: Implications for disease control (Supervisor- Dr. Jo-Anne R. Dillon)
- Master of Medicine (MMed): Graduate study in Microbiology/Parasitology, Fudan University (Formerly Shanghai Medical University), Shanghai, China (09/1985-07/1988) Research topic: Ultrastructure of metacercarial membrane of and immune response of rats infected with *Paragonimus westermani* (Supervisor- Dr. TingHuang Wen and Dr. PeiFang Fan).
- Bachelor of Medicine (MD): Fudan University School of Public Health (Formerly Shanghai Medical University, School of Public Health), Shanghai, China (09/1980-06/1985)
- Postdoctoral Fellow: Hormone and Development Division, Ottawa Health Research Institute, Ottawa, Canada (05/1999-03/2003). Research topic: steroid hormone receptor (Supervisor- Dr. Robert Hache)
- Postdoctoral training: The Laboratories for Reproductive Biology, Department of Biophysics and Biochemistry, University of North Carolina at Chapel Hill, North Carolina, USA (11/1995-03/1999). Research topic: Androgen receptor and reproductive biology (Supervisor- Dr. Elizabeth M. Wilson and Dr. Frank S. France)
- Other professional training: Clinical laboratory diagnosis of STD, UNC Hospital, University of North Carolina at Chapel Hill (UNC-CH). (Supervisor- Dr. Myron Cohen)
- Other professional development:
  - Pass standing MCCEE (Medical Council of Canada Evaluating Examination)
  - Associate member, Canadian College of Microbiologists

## Employment & Experience:

- **Sept.2004-present (I):** Laboratory manager, University of Saskatchewan, Saskatoon, Canada. (Supervisor- Dr. Jo-Anne R. Dillon)  
*I have managed a research unit with ~8 staff and several research grants simultaneously for more than 6 years.*
  1. *Responsibilities:* I am responsible for the managerial and academic dimensions of a research laboratory with multiple ongoing research projects, overseeing these projects from formulation to dissemination of results.
    - 1) ensure safety regulations are followed, including transportation/receiving dangerous goods and importation of pathogens;
    - 2) develop standard operation procedures;
    - 3) oversee the efficient operation of the laboratory and multiple research grant management;
    - 4) recruit and supervise students, technicians, postdoctoral fellows and other personnel on a day-to-day basis;
    - 5) oversee the design of data management systems;
    - 6) maintain a comprehensive overview of all research projects and their progress;
    - 7) appraise and consult research literature;
    - 8) develop and perform appropriate research activities;
    - 9) co-ordinate/manage result and data, and utilize biomedical and bioinformatics to analyze data;
    - 10) write/design/present manuscripts, grants, reports and abstracts;
    - 11) overview budget;
  2. *Preparation of grant application and report:* In addition to the grants I applied for as a co-investigator, I have drafted/vented several research grant proposals for the laboratory PI to CIHR, NSERC, IDRC, SHRF and other funding agencies.
  3. *Fund management through UNIFI of the University of Saskatchewan.*
  4. *Collaboration:* Establishment and maintenance of broad regional, national and international collaborations of this research unit by organizing and communicating with broad stakeholders of research teams, including research grant applications, managing collaborating projects and exploring funding opportunities for such collaborations.
  
- **Sept.2004-present (II):** Research scientist, Vaccine and Infectious Disease Organization, University of Saskatchewan, Saskatoon, Canada. (Supervisor- Dr. Jo-Anne R. Dillon)
  1. *Molecular epidemiology of infectious diseases:* In collaboration with researchers from U of Ottawa, U of Saskatchewan and the Shanghai Skin Disease and STD Hospital, I have investigated antibiotic resistance and strain specific transmission of *Neisseria gonorrhoeae* and *Chlamydia trachomatis* infections in China using comprehensive approaches of epidemiology, molecular epidemiology, social sciences, genetics and bioinformatics.
  2. *Molecular microbiology:* I have used various methods to explore cell division mechanisms using *N. gonorrhoeae* and *Enterococcus faecalis* as model microorganisms. Those techniques include molecular biology, biochemistry, phase contrast and fluorescence microscopy, microbiology and genetics. DNA sequencing;

molecular cloning; quantitative PCR; assembly and/or use of protein-expression constructs.

- **Feb. 2003-Aug.2004:** Research Associate, Dept. of Biochemistry, Microbiology and Immunology, University of Ottawa, Ottawa, Canada. (Supervisor- Dr. Jo-Anne R. Dillon)
  1. Molecular microbiology: Research focus on molecular mechanisms of bacterial cell division of *E. faecalis*. Systems and techniques used include mutagenesis, yeast two hybrid, bioinformatics, co-immunoprecipitation, GST pulldown, RT-PCR, fluorescence microscopy. DNA sequencing; molecular cloning; quantitative PCR; assembly and/or use of protein-expression constructs. His-tagged protein expression and purification.
  2. Antimicrobial resistance in bacterial pathogens
  3. Mentoring undergraduate and graduate students
  4. Writing grant applications, scientific papers and presentations.
  5. Management of research, human resources and funds for the unit.
  
- **May 1999- Feb. 2003** Postdoctoral Fellow, Hormone and Development Division, Ottawa Health Research Institute, Ottawa, Canada. (Supervisor- Dr. Robert Hache)
  1. Molecular biology: Research focus on MMTV transcription regulation by glucocorticoid receptor and octamer protein. Systems and techniques used include mammalian two hybrid, yeast two hybrid, xenopus oocyte microinjection, cloning, PCR, RT-PCR, footprinting, IP, chromatin-IP, Northern blot and Southern blot
  2. Academic instruction of undergraduate students
  
- **1996-1999** Postdoctoral Fellow, Laboratories for Reproductive Biology, Department of Biochemistry and Biophysics, University of North Carolina at Chapel Hill, North Carolina, USA. Co-sponsored by the International Training and Research Program in Population and Health of the John E. Fogarty International Center for Advanced Study in the Health Sciences. (Supervisor- Dr. Elizabeth M. Wilson and Dr. Frank S. France)
  1. Endocrinology and reproductive biology
  2. Research project on androgen receptor overexpression, purification and characterization. Techniques used included cloning, mammalian cell culture and protein expression, chromatography, DNA mobility shift assay, monoclonal antibody production, etc.
  
- **1995-1996** Clinical laboratory diagnosis of STD. UNC Hospital, University of North Carolina at Chapel Hill (Supervisor- Dr. Myron Cohen)
  
- **1994-1995** Physician and public health researcher, Shanghai Institute for Planned Parenthood Biology, WHO Collaborating Center, Shanghai, China
  1. Clinical physician in STIs
  2. Studies focus on clinical epidemiology and health social science of STIs
  3. Management of Foreign Affair Office of the institute
  
- **1991-1994** Physician and epidemiological researcher, Shanghai Skin Disease and STD Hospital, Shanghai, China

1. Clinical physician in skin diseases and STIs
2. Research on social science and epidemiology of STIs/AIDS
3. Office management and editor of the hospital journal

- **1989-1991** Residency, HuaShan Hospital, Shanghai Medical University, Shanghai, China

**Research Funding:**

- “Strain specific transmission of sexually transmitted diseases in sexual networks in China: implications for prevention”. The Canadian Institutes of Health Research (CIHR), Operating grant. A.M. Jolly, Y. Chen, J.R. Dillon, **M. Liao**, W. Gu, L.E. Leonard, P.A. Sandstrom and J.L. Wylie. 2005 – 2008, extended to Mar 2011; \$326,883.
- “Strain specific transmission of gonorrhoeae in sexual networks in Shanghai: implications for prevention”. CIHR, International Opportunity Program; one time collaborative research project grant (OPC67917). Ann M. Jolly, Yue Chen, Jo-Anne R. Dillon, **Mingmin Liao**, and Weiming Gu. May 2004 – May 2005, 99,500\$.

**Awards and Honours:**

- Best post award, Epidemiology, the 15<sup>th</sup> International Pathogenic Neisseria Conference (IPNC), September 10-16, 2006, Cairns, Australia.
- Travel grant: Sino-US AIDS research collaborating program, sponsored by NIH and China Health Ministry. October 28<sup>th</sup>-November 3<sup>rd</sup>, 2002. Beijing, China.
- Travel grant: The 85<sup>th</sup> Annual Meeting of American Society of Endocrinology, June 12-15<sup>th</sup>, 2000. Toronto, Canada
- Fogarty International Postdoctoral Scholarship: For postdoctoral training in reproductive biology at the University of North Carolina at Chapel Hill USA, 01/1997-03/1999.
- WHO Scholarship: For research training in microbiology of sexually transmission diseases at the University of North Carolina at Chapel Hill USA, 11/1995-11/1996.
- Fogarty travel grant: The annual meeting of the international research training sponsored by Fogarty International Center and NIH. May 11-12<sup>th</sup>, 1997. Bethesda, USA
- WHO scholarship: Seminar on laboratory diagnosis of STDs/HIV in Nanjing, China Sponsored by World Health Organization, May-June, 1989
- Distinct student awards: 1983, 1984, 1985. Shanghai Medical University
- Distinct undergraduate award: 1985, Shanghai Medical University

**Supervisory Experience (from 2001):**

Undergraduate classes:

- Micro 390, Fall 2010, Lab, U of Sask
- Micro 391, Fall 2009, Lab, U of Sask
- Micro 216, Spring 2009, lecture to lab, lab instruction and marking, U of Sask
- Micro 390, Lab, Fall 2008, U of Sask
- Micro 391, Lab, Fall 2007. U of Sask

Individual or group supervision from 2004 to present:

I have provided mentoring/direct instruction/supervision on a day-to-day basis to the following students and research personnel (ongoing and completed, as of May 24, 2011).

- Research Associate (2)
- Postdoctoral fellow (5)
- Graduate students (MSc and PhD) (10)
- Research technician and Research Office Administrator (16)
- Visiting scientist (3)
- Honours and summer student (12)
- High school student (6)

#### Committee:

- Abstract reviewer. Committee of Antimicrobial Resistance. The 17<sup>th</sup> International Pathogenic Neisseria Conference (IPNC), Banff, Alberta, Canada. September 11-16, 2010.

#### Memberships:

- Associate member- Canadian College of Microbiologists (CCM), 2009-
- Member – Canadian Association for Clinical Microbiology and Infectious Diseases (CACMID), 2010-
- Member- American Society of Microbiology (ASM), 2005-
- Member- American Sexually Transmitted Disease Association (ASTDA), 2005-
- Member- International Collaboration on Gonococci (ICG) and ICG website curator ([www.icgngo.org](http://www.icgngo.org)). 2005-

#### Publications:

*Papers in referred journals: [Papers derived from the PhD study are indicated with stars (n=3)]*

1. **\*M. Liao**, W-M Gu, Y. Yang and J.R. Dillon. 2011. Analysis of mutations in multiple loci of *Neisseria gonorrhoeae* isolates reveals effects of PIB, PBP2 and MtrR on reduced susceptibility to ceftriaxone. *J. Antimicrob. Chemother.* **66**:1016-1023.
2. P.S. Ruddock, M. Charlan, S. Ramirez-Arcos, A. Lopez, G.H.N. Towers, J.T. Arnason, **M Liao**, J.R. Dillon. 2011. Antimicrobial activity of *Piper lanceaefolium* and other Colombian medicinal plants against antibiotic susceptible and resistant strains of *Neisseria gonorrhoeae*. *Sex. Transm. Dis.* **38**:82-88.
3. **\*M. Liao**, S. Helgeson, W-M Gu, Y. Yang, A.M. Jolly and J.R. Dillon. 2009. Comparison of *Neisseria gonorrhoeae* Multiantigen Sequence Typing and *porB* sequence analysis for identification of clusters of *N. gonorrhoeae* isolates. *J. Clin. Microbiol.* **47**:489-491.
4. M.D. Rigden, C. Baier, S. Ramirez-Arcos, **M. Liao**, M. Wang and J.R. Dillon. 2008. Identification of the coiled-coil domains of *Enterococcus faecalis* DivIVA that mediate oligomerization and their importance for biological function. *J. Biochem.* **144**:63-76.
5. **\*M. Liao**, K. Bell, W-M Gu, Y. Yang, N.F. Eng, W. Fu, L. Wu, C-G Zhang, Y. Chen, A.M. Jolly, and J.R. Dillon. 2008. Clusters of circulating *Neisseria gonorrhoeae* strains and association with antimicrobial resistance in Shanghai. *J. Antimicrob. Chemother.* **61**:478-487.
6. V. Greco-Stewart S., Ramirez-Arcos, **M. Liao** and J.R. Dillon. 2007. N-terminus determinants of MinC from *Neisseria gonorrhoeae* mediate interaction with FtsZ but do not affect interaction with MinD or homodimerization. *Arch. Microbiol.* **187**:451-458.
7. Yang Yang, **M. Liao**, Wei-Ming Gu, Kelli Bell, Lei Wu, Nelson F. Eng, Chu-Guang Zhang,

- Yue Chen, Ann M. Jolly, and Jo-Anne R. Dillon. 2006. Antimicrobial susceptibility and molecular determinants of quinolone resistance in *Neisseria gonorrhoeae* isolates from Shanghai. *J. Antimicrob. Chemother.* **58**:868-872.
8. **M. Liao**, P. S. Ruddock, A. S. Rizvi, S. H. Hall, F. S. French and J. R. Dillon 2005. Cationic peptide of the male reproductive tract, HE2 $\alpha$ , displays antimicrobial activity against *Neisseria gonorrhoeae*, *Staphylococcus aureus* and *Enterococcus faecalis*. *J. Antimicrob. Chemother.* **56**: 957-961.
  9. Sandra Ramirez-Arcos, **M. Liao**, Susan Marthaler, Marc Rigden, and Jo-Anne R. Dillon. 2005. *Enterococcus faecalis divIVA*: an essential gene involved in cell division, cell growth, and chromosome segregation. *Microbiol.* **151**:1381–1393.
  10. Ruddock PS, **M. Liao**, B. Foster, L. Lawson, J.T. Arnason and J.R. Dillon. 2005. Garlic natural health products exhibit variable constituent levels and antimicrobial activity against *Neisseria gonorrhoeae*, *Staphylococcus aureus* and *Enterococcus faecalis*. *Phytother. Res.* **19**:327–334.
  11. W-M Gu, **M. Liao**, Y. Yang, Lei WU, WZ Hu. 2004. [Detection of HSV-2-IgG, HBsAg and HCV in patients with STD and HIV infection.] *Chin J Dermatol* **37(5)**:288-289. [English abstract].
  12. Savory JG, Prefontaine GG, Lamprecht C, **Liao M**, Walter RF, Lefebvre YA, Hache RJ. 2001. Glucocorticoid receptor homodimers and glucocorticoid-mineralocorticoid receptor heterodimers form in the cytoplasm through alternative dimerization interfaces. *Molec. Cell. Biol.* **21(3)**:781-93.
  13. **M. Liao** and Elizabeth W. Wilson. 2001. Production and Purification of Histidine-Tagged Dihydrotestosterone Bound Full-Length Human Androgen Receptor. *Methods in Molecular Biology Volume 176, Steroid Receptor Methods—Protocols and Assays* Edited by Benjamin A. Lieberman, Humana Press, p67-80.
  14. **Liao M**, Zhou ZX, Wilson EM. 1999. Redox-dependent DNA binding of the purified androgen receptor: evidence for disulfide-linked androgen receptor dimers. *Biochem.* **38(30)**:9718-27.
  15. H.Z. Qian, **M. Liao** and P.F. Zhao. 1998. [**Analysis of Infection Sources and Care-seeking Behaviour among STD Clinic Clients**] (English abstract). *Chinese Journal of Dermatology* [Zhonghua Pi Fu Ke Zha Zhi] **31(3)**:171-173
  16. P.F. Zhao, H. Lu, **M. Liao**, Shah I, Munding A. 1997. [Sexual behaviour and condom use among STDs patients in Shanghai. In: Gao Ersheng, Shah I, eds. *Progress of social science research on reproductive health: anthology of treatises of the international symposium on social science research in reproductive health*]. Beijing. China Population Publishing House, 1997, 29–39.
  17. **M. Liao**, P.F. Zhao, L.B. Xiao. 1996. [Social-demographic characteristics and treatment-seeking behaviour of STD patients in China.] *Chin J Dermatol Sex Transm Dis* **10**:286–287.
  18. P.F. Zhao, **M. Liao**, HZ Qian et al 1996. [Analysis of Ages of first sexual intercourse and influence factors in STD patients in Shanghai]. *Chin STD and AIDS Prevention* [Zhongguo Xing Bing Ai Zhi Bing Fang Zhi] **2**:10-13.
  19. Zhao PF, Qian HZ, **M. Liao**, Lu H. 1996. [Psycho-social & behavioral characteristics of STD patients]. *Chin J STD/AIDS Prev Control.* **2**:270-273.
  20. Zhao PF and **M. Liao**. 1994. [In-depth interview plus behavioral survey of STD patients in Shanghai: a pilot report] [Article in Chinese] *Chin Sexol* [Zhongguo Xin Xue] **1**:35-37.
  21. **M. Liao** and Xiao LB. 1991. [Vaginal spermicide against STDs in women (review)] [Article

- in Chinese] Foreign Med Dermatol. [Guo Wai Yi Xue Pi Fu Bing Feng Che] **17(3)**: 150-153.
22. Xiao LB and **M. Liao**. 1991. [Sexually transmitted diseases: their prevalence and research status in China (review)]. Medicine Progress [Yi Xue Jing Zhang] p143-146.
  23. **M. Liao**, Gu WM, Xiao LB, Le JY. 1991. [Prevalence of *chlamydia trachomatis* infection in STD high risk groups in Shanghai]. Chin J Dermatol [Zhonghua Pi Fu Ke Zha Zhi] **24(2)**: 253-255.
  24. **M. Liao**, Huan PF and Wen TH. 1991. [Histological study of metacercariae of *Paragonimus westermani*]. Chin J Parasitic Dis Control [Zhongguo Ji Sheng Chong Bin Yi Fan Zha Zhi] **3(2)**:143-145.
  25. **M. Liao**, Huan PF, Wen TH. 1990. [Ultrastructure of metacercarial membrane and immunohistochemical localization of metacercarial membrane reaction of *Paragonimus westermani*]. [English Abstract]. Chin J Parasitol Parasitic Dis [Zhongguo Ji Sheng Chong Xue Yu Ji Sheng Chong Bing Za Zhi] **8(2)**:108-109.
  26. **M. Liao**, Huan PF and Wen TH. 1990. [Antibody response of rabbit infected with *Paragonimus westermani*] [Article in Chinese] Shanghai Immunol J [Shanghai Mian Yi Xue Zha Zhi] **10(1)**:19-21.
  27. ....**M. Liao** .... 1986. [China Environmental microbiology], *the second author, derived from my undergraduate thesis*.

*Manuscripts in preparation: [Papers derived from the PhD study are indicated with stars (n=1)]*

1. \***M. Liao**, W-M Gu, Y. Yang and J.R. Dillon. 2011. Trends of antimicrobial resistance in *Neisseria gonorrhoeae* in China. To be submitted to Sex Transm Dis.
2. **M. Liao**, M. Wang, C. Baier, K. Perdrizet, Y. Li, D. Sikora, S. Ramirez-Arcos and J.R. Dillon. 2011. Novel Protein Interactions Characterize Cell Division in *Enterococcus faecalis*. To be submitted to Mol Microbiol.
3. S.D. Thakur, **M. Liao**, E. Nagle, C. Heldin, P. Levett, G. Horsman, J.R. Dillon. 2011. Trends in antimicrobial resistance of *Neisseria gonorrhoeae* isolates from Saskatchewan: Need to make more effective use of antimicrobial agents. In preparation.
4. S. Starnino, P. Galarza; I. Pagano; M. E. Trigoso; A. Schwartz Benzaken; V. M. Pinto; A. Maldonado Ballesteros; O. M. Sanabria Cruz; A. Llop; E. Aguilar Jarrin; N. Aguayo; J. L. Portilla Carbajal; G. Borthagaray; A. Acevedo; D. Payares, **M. Liao**, M. Ruben, A. Storey and J. R. Dillon. 2011. *Neisseria gonorrhoeae* antimicrobial susceptibility in Latin America and Caribbean (2000 -2009): A contribution to the treatment guidelines revision. To be submitted to STD.
5. D. Biswas, R. Parti, M. Wang, **M. Liao** and J.R. Dillon. A MinD mutant of enterohemorrhagic *E. coli* O157:H7 has reduced adherence to human epithelial cells. Submitted to Microbial Pathogenesis July 22, 2010. MS#: YMPAT-D-10-00134. Under revision, 2011.
6. S. Starnino, K. Brandt, R.R. McDonald, P.N. Levett, **M. Liao** and J.R. Dillon. 2011. Typing *Neisseria gonorrhoeae* and *Chlamydia trachomatis* from co-infected patients by analyzing gonorrhoea positive urine specimens. Sex. Transm. Dis. MS# STD11-43. Submitted in February 2011. Under revision.
7. S. Vidovic, **M. Liao**, G.B. Horsman and J.R. Dillon. 2011. A gonococcal MLST scheme suitable for short and long-term molecular epidemiological analyses that provides a high index of discrimination. In preparation.

*Meeting presentations, published abstracts/posters: [Papers derived from the PhD study are indicated with stars (n=9)]*

1. S.D. Thakur, E. Nagle, P.N. Levett, G. Horsman, **M. Liao**, and J.R. Dillon. 2011. Emerging molecular mutations of reduced susceptibility to third-generation cephalosporins in *Neisseria gonorrhoeae* isolates from Saskatchewan, Canada. Abstract accepted. The 19<sup>th</sup> Biennial Meeting of the International Society for Sexually Transmitted Disease Research (ISSTDR), 10-13 July, 2011. Quebec City, Canada.
2. S. Starnino, P.G. Galarza, I. Panago, M.E. Trigos, A.S. Benzaken, V.M. Pinto, A.M. Ballesteros, O.M.S. Cruz, A. Llop, E. Aguilar, N. Aguayo, J.L.P. Carbajal, G. Borthagaray, A. Acevedo, D. Payares, **M. Liao**, M. Ruben, A. Storey, and J.R. Dillon. 2011. Survey of methodology used for the identification and antimicrobial susceptibility testing of *Neisseria gonorrhoeae* in Latin America and the Caribbean. Abstract accepted. The 19<sup>th</sup> Biennial Meeting of ISSTDR, 10-13 July, 2011. Quebec City, Canada.
3. S. Starnino, P.G. Galarza, I. Panago, M.E. Trigos, A.S. Benzaken, V.M. Pinto, A.M. Ballesteros, O.M.S. Cruz, A. Llop, E. Aguilar, N. Aguayo, J.L.P. Carbajal, G. Borthagaray, A. Acevedo, D. Payares, **M. Liao**, M. Ruben, A. Storey, and J.R. Dillon. 2011. *Neisseria gonorrhoeae* Antimicrobial Susceptibility in Latin America and the Caribbean (2000-2009): A Contribution to the Treatment Guidelines Revision. Abstract accepted. The 19<sup>th</sup> Biennial Meeting of ISSTDR, 10-13 July, 2011. Quebec City, Canada.
4. S. Vujanovic, S. Vidovic, **M. Liao**, J.R. Dillon. 2010. Multilocus sequence typing reveals outbreaks and circulating strains of *Neisseria gonorrhoeae*. 2010 NSERC USRA Poster Event. August 27, 2010. Student Lounge, College of Education, University of Saskatchewan.
5. J.R. Dillon, C. Hedlin, E. Nagle, G. Horsman and **M. Liao**. 2009. Spatial and Temporal Distributions of *Neisseria gonorrhoeae* Strains in Saskatchewan: Implications for Disease Control. Poster presentation. The RAPID Annual Meeting 2009, Radisson Hotel, Saskatoon, Saskatchewan. August 26, 2009.
6. **\*M. Liao**, W.-M. Gu, Y. Yang, A.M. Jolly and J.R. Dillon. 2009. Trends in the antimicrobial resistance and resistance determinants of *Neisseria gonorrhoeae* from Shanghai (2005 and 2008). Poster presentation. The 18<sup>th</sup> Biennial Meeting of International Society for Sexually Transmitted Disease Research (ISSTDR), June 28-July 1, 2009. London, UK.
7. **\*M. Liao**, W.-M. Gu, Y. Yang, A.M. Jolly and J.R. Dillon. 2009. Evolution of strain types in *Neisseria gonorrhoeae* isolates in Shanghai (2005 AND 2008) based on *porB* and NG-MAST analysis. Poster presentation. The 18<sup>th</sup> Biennial Meeting of ISSTDR, June 28-July 1, 2009. London, UK.
8. J.R. Dillon, K. Perdrizet, **M. Liao**, C. Hedlin. 2009. Necessity of re-establishing the Gonococcal Antimicrobial Susceptibility (GASP) network in Latin America and the Caribbean. *Invited Oral Presentation*. Workshop of International Collaboration on Gonococci (ICG), the 18<sup>th</sup> Biennial Meeting of ISSTDR, June 28-July 1, 2009, London, UK.
9. **\*Jolly AM, M. Liao**, Gu W, Zhang C, Yang Y, Wu L, Chen Y, Dillon JR, Wylie JL. 2009. Correlation of geographic and genetic distance in couples infected with *N. gonorrhoeae* in Shanghai. Oral presentation by AMJ. The 18<sup>th</sup> Biennial Meeting of ISSTDR, June 28-July 1, 2009. London, UK.
10. **\*M. Liao**, S. Helgeson, W-M. Gu, Y. Yang, A.M. Jolly and J.R. Dillon. 7-12 September 2008. Poster presentation. Comparison of NG-MAST and *porB* sequence analysis in



- identifying clusters of *Neisseria gonorrhoeae* isolates. The 16<sup>th</sup> International Pathogenic Neisseria Conference (IPNC), Rotterdam, the Netherlands.
11. M.A. Horbay, K. Bell, **M. Liao** and J.R. Dillon. Poster presentation. June 9-12, 2008. OxyR regulates min gene expression in *Neisseria gonorrhoeae*. The 58th Annual Conference of the Canadian Society of Microbiologists (CSM). University of Calgary, Calgary, AB.
  12. C. Baier, M. Rigden, M. Wang, **M. Liao** and J.R. Dillon. Poster presentation. June 9-12, 2008. Essentiality of Oligomerization for Proper Function of DivIVA in *Enterococcus faecalis* Cell Division and Interaction with a Novel Protein. The 58th Annual Conference of CSM. University of Calgary, Calgary, AB.
  13. Y. Li, **M. Liao** and J.R. Dillon. *INVITED POSTER*. 6 December, 2007. Exploring the role of FtsA in early divisome formation in *Neisseria gonorrhoeae*. Saskatchewan Health Research Foundation. Bellsborough Hotel, Saskatoon, Saskatchewan Award Dinner. Bellsborough Hotel, Saskatoon, Saskatchewan. December 6, 2007.
  14. **\*M. Liao** and J.R. Dillon. *Invited oral presentation*. Por types and mutations associated with antimicrobial resistance in *N. gonorrhoeae* isolates. The International Collaboration on Gonococci (ICG) Workshop, the 17<sup>th</sup> Conference of ISSTDR, Seattle, Washington, USA. July 28-August 1, 2007.
  15. **\*Jolly AM, Liao M,** Gu W, Zhang C, Wu L, Yang Y, Chen Y, and Dillon JR. Correlation of social and genetic distance in couples infected with *N. gonorrhoeae* in Shanghai. Program of the 17th ISSTDR 2007, p315-316. Seattle, Washington, USA.
  16. **\*Shurgold JH, Liao M,** Yang Y, Wu L, Zhang C, Chen Y, Dillon JR, Gu W, and Jolly AM. Evaluation of social network enhanced contact tracing in Shanghai. Program of the 17th ISSTDR 2007, p215-216.
  17. **\*Shurgold JH, Jolly AM, Liao M,** Gu W, Zhang C, Yang Y, Wu L, Dillon JR, Gu W, and Chen Y. Risk factors for condom use in sexual intercourse among male subjects with gonorrhea in Shanghai. Program of the 17th ISSTDR 2007, p267.
  18. **\*Apedaile BE, Cameron W, Ramsey T, Liao M,** Shurgold J, Gu W, Chen Y, Dillon JR, and Jolly AM. How much sex does it take to catch gonorrhea? Frequency of sexual intercourse between couples resulting in transmission of *N. gonorrhoeae* in Shanghai. Program of the 17th ISSTDR 2007, p315.
  19. **\*Liao M.,** Kelli Bell, Wei-Ming Gu, Yang Yang, Nelson F. Eng, Wenkai Fu, Lei Wu, Chu-Guang Zhang, Yue Chen, Ann M. Jolly, and Jo-Anne R. Dillon. 2006. Genetic Diversity of *porB* for 174 *Neisseria gonorrhoeae* Isolates from Shanghai: Impact on Molecular Epidemiology and Antimicrobial Resistance. The 15<sup>th</sup> IPNC, 10-15 September 2006, Cairns, Australia. Awarded Best Poster in Epidemiology.
  20. Yang Yang, **Liao M.,** Wei-Ming Gu, Kelli Bell, Lei Wu, Nelson F. Eng, Chu-Guang Zhang, Yue Chen, Ann M. Jolly, and Jo-Anne R. Dillon. 2006. Antimicrobial Susceptibility and Molecular Determinants of Quinolone Resistance in *Neisseria gonorrhoeae* Isolates from Shanghai. The 15<sup>th</sup> IPNC, 10-15 September 2006, Cairns, Australia.
  21. **Liao M.,** Bell, K., Yang, Y., Eng, N.F., Gu, W.M., Chen, Y., Jolly A.M., and J.R. Dillon. 2005. Strain differentiation of *Neisseria gonorrhoeae* isolates from identified sex networks in Shanghai by genetic typing. The 16<sup>th</sup> Biennial Meeting of ISSTDR, July 10-13, Amsterdam.
  22. **Liao M.,** Bell, K., Li, H., Eng, N.F., and J.R. Dillon. 2005. Comparison of ribotyping, pulsed-field gel electrophoresis and genetic typing to discriminate gonococcal strains associated with either outbreak clusters or random isolates with IB-5 and IB-7. 16<sup>th</sup> Biennial Meeting of ISSTDR, July 10-13, Amsterdam.

23. **Liao M.**, Ruddock, P.S., Rizvi, A.S., Hall, S.H., French, F.S., and J.R. Dillon. 2005. Antibacterial activity of a cationic peptide, HE2a, against *Neisseria gonorrhoeae*, *Staphylococcus aureus*, and *Enterococcus faecalis*. 16<sup>th</sup> Biennial Meeting of ISSTDR, July 10-13, Amsterdam.
24. Gu WM, Yang Y, Lei W, Hu WZ, Wang HS, **Liao M.** 2003. Prevalence of HSV, HBV and HCV in STD clinical patients and HIV positive individuals in Shanghai. The 15<sup>th</sup> Biennial Congress of ISSTDR. July 27-30<sup>th</sup>, 2003. Ottawa, Canada.
25. Gu WM, Yang Y, Lei W, Gao ZQ, Wang HS, **Liao M.** 2003. Surveillance of antibiotic susceptibility of *Neisseria gonorrhoeae* in Shanghai: 1988-2002. The 15<sup>th</sup> Biennial Congress of ISSTDR. July 27-30<sup>th</sup>, 2003. Ottawa, Canada.
26. Ruddock P, **Liao M.**, Foster B, Dillon JR. 2003. Antimicrobial activity of garlic natural health products against *Neisseria gonorrhoeae*. The 15<sup>th</sup> Biennial Congress of ISSTDR. July 27-30<sup>th</sup>, 2003. Ottawa, Canada.
27. **Liao M.**, Savory JG, Lefebvre YA, and Hache RJ. 2000. Oct binding to Oct-motif is required for hormone-dependent GR activation of MMTV. Poster and Abstract. The 85<sup>th</sup> Annual Meeting of American Society of Endocrinology, June 12-15<sup>th</sup>, 2000. Toronto, Canada. Won Travel Award.
28. **Liao M** and Zhao PF. 1994. [Preliminary analysis of clinical characteristics of STD patients in Shanghai] [Article in Chinese]. Presentation and abstract for the International Symposium on Social Science Research in Reproductive Health, sponsored by WHO, Shanghai, October 11-15, 1994.

*Invited Presentations at National/International Conferences*

1. **\*Liao M.** and J.R. Dillon. 2007. *Invited oral presentation*, the International Collaboration on Gonococci (ICG) workshop in conjunction with ISSTDR2007: Por types and novel mutations associated with antimicrobial resistance in *N. gonorrhoeae* isolates. 17th ISSTDR 2007, p315-316. Seattle, Washington, USA.
2. **Liao M.** 2006. *Invited oral presentation*, the International Collaboration on Gonococci (ICG) workshop in conjunction with IPNC2006: Development of a website for the ICG. 15<sup>th</sup> IPNC, 10-15 September 2006, Cairns, Australia.