

MONITORING AND MODELLING DIURNAL AND SEASONAL  
ODOUR AND GAS EMISSION PROFILES FOR  
SWINE GROWER/FINISHER ROOMS

A Thesis Submitted to the College of  
Graduate Studies and Research  
In Partial Fulfillment of the Requirements  
For the Degree of Master of Science  
In the Department of Agricultural and Bioresource Engineering  
University of Saskatchewan  
Saskatoon

By  
Gang Sun

© Copyright Gang Sun, November, 2005. All rights reserved.

## **PERMISSION TO USE**

In presenting this thesis in partial fulfilment of the requirements for a Postgraduate degree from the University of Saskatchewan, I agree that the Libraries of this University may make it freely available for inspection. I further agree that permission for copying of this thesis in any manner, in whole or in part, for scholarly purposes may be granted by the professor who supervised my thesis work or, in her absence, by the Head of the Department or the Dean of the College in which my thesis work was done. It is understood that any copying or publication or use of this thesis or parts thereof for financial gain shall not be allowed without my written permission. It is also understood that due recognition shall be given to me and to the University of Saskatchewan in any scholarly use which may be made of any material in my thesis.

Requests for permission to copy or to make other use of material in this thesis in whole or part should be addressed to:

Head of the Department of Agricultural and Bioresource Engineering

University of Saskatchewan

Saskatoon, Saskatchewan S7N 5A9

## **ABSTRACT**

To address odour and gas problems generated by livestock facilities, air dispersion models have been used to determine reasonable science-based setback distances between the livestock operations and the neighbouring residences. However, none of the existing models consider diurnal, seasonal and climate variations of odour and gas (ammonia, hydrogen sulphide, carbon dioxide) concentrations and emission rates (OGCER), which may result in great uncertainties in setback distance calculations. Thus, the purpose of this project was to monitor and model diurnal and seasonal OGCER from swine grower/finisher rooms. Specifically, this research was conducted to: 1) characterize diurnal OGCER between two different flooring systems (fully and partially slatted floorings) under three different weather conditions (August, October and February); 2) identify seasonal OGCER over a 12-month measuring period; and 3) develop mathematical models to predict the OGCER.

A two-factorial strip-block experiment was designed for measuring diurnal OGCER in two grower/finisher rooms. It was found that: 1) the diurnal OGCER in the fully slatted flooring system was 27.6 to 39.5% higher than that in the partially slatted flooring system; however, no significant differences in the diurnal OGCER were found between the two rooms, except for the NH<sub>3</sub> concentrations in August, the NH<sub>3</sub> and H<sub>2</sub>S concentrations and emissions in October, and odour concentrations and emissions in

February ( $P > 0.05$ ), and 2) significant diurnal variations in the OGCER (except for the odour concentrations and H<sub>2</sub>S emissions) have been observed in August ( $P < 0.05$ ); only gas emissions showed significant fluctuation patterns in October ( $P < 0.05$ ); no significant variations in the OGCER (except for the CO<sub>2</sub> concentrations and emissions) were found in February ( $P > 0.05$ ).

A repeated measurement method was used to monitor seasonal OGCER in four grower/finisher rooms over a period of 12 months. It was found that: 1) the seasonal OGCER from the fully slatted flooring system was 2.9 to 40.6% higher than that from the partially slatted flooring system; however, the seasonal OGCER (except for the NH<sub>3</sub> concentrations in October, November and January; the CO<sub>2</sub> concentrations in August and the CO<sub>2</sub> emissions in December) between the two different floors for each measuring month did not differ significantly ( $P > 0.05$ ); and 2) the seasonal OGCER was significantly affected by the sampling month ( $P < 0.05$ ), and no specific seasonal pattern was observed.

The statistical models developed for each type of the flooring system determined the OGCER based on the room and ambient temperatures, the ventilation rates and the animal units. The predicted results showed good agreement with measured values for most of OGCER ( $r^2$ : 0.67-0.95). In order to improve odour and gas prediction models, animal activity and dirtiness of pens should be further investigated.

## **ACKNOWLEDGEMENTS**

I would like to express my sincere appreciation to my supervisor, Dr. Huiqing Guo, for her guidance, help and encouragement through this research project, especially for getting me started on a promising research area, air quality engineering, as well as always giving me the space to find my own way, the patience to let me wander, and the support to help me finish the journey.

I would also like to thank the members of my advisory committee, Dr. Charles Maulé, Dr. Claude Laguë and Dr. Bernardo Predicala for their generous guidance, especially for their efforts to this thesis.

I wish to give thanks to Mr. Wayne Morley for his guidance in the design of the embedded microcomputer-based environment measuring system, and my best friend Jonathan Peterson for his great help with this research and my life in Saskatoon. Sincere thanks are also extended to Dr. Jifeng Ying, Yanan Xing, Ryan Kreuger, Pat Bowman, Lifang Liu, Yongxin Li, Xue Li, Dena Burnett, and Mark Shaw for their support.

I thankfully acknowledge the financial assistance from the Natural Sciences and Engineering Research Council of Canada and the Saskatchewan Agricultural Development Fund.

Finally, I would like to dedicate this work and express special gratitude to my parents, Dakai Sun and Shiyang Xiang, for their understanding, support and encouragement all the time.

## TABLE OF CONTENTS

PERMISSION TO USE .....	I
ABSTRACT .....	II
ACKNOWLEDGEMENTS .....	IV
TABLE OF CONTENTS .....	VI
LIST OF TABLES .....	IX
LIST OF FIGURES .....	XI
1. INTRODUCTION.....	1
2. LITERATURE REVIEW .....	3
2.1 Diurnal and Seasonal Odour Emission Measurement .....	3
2.2 Odour Concentration and Emission Measurement .....	5
2.2.1 Odour Measurement Method.....	5
2.2.2 Previous Odour Concentration and Emission Research .....	6
2.3 Gas Concentration and Emission Measurement .....	9
2.3.1 Gas Measurement Method.....	9
2.3.2 Previous Gas Concentration and Emission Research .....	10
2.4 Ventilation Rate Measurement Method .....	13
2.5 Summary of Literature Review .....	14
3. OBJECTIVES .....	16
4. MATERIALS AND METHODS .....	17
4.1 Description of Experimental Swine Rooms .....	17
4.2 Odour and Gas Concentration and Emission Measurement Experiment Design ..	19
4.2.1 Diurnal Measurement Experiment Design and Statistical Analysis.....	19
4.2.2 Seasonal Measurement Experiment Design and Statistical Analysis.....	23
4.2.3 Diurnal and Seasonal Odour and Gas Modelling Method.....	26
4.3 Odour and Gas Emissions Measurement Methods .....	27
4.3.1 A General View of Odour and Gas Measurement.....	27
4.3.2 Odour Concentration Measurement .....	29
4.3.3 Gas Concentration Measurement .....	30

4.3.4 Ventilation Rate Measurement .....	31
4.4 Environmental Parameters Measurement .....	34
4.5 Embedded Microcomputer-based Environment Measuring System Design .....	34
4.6 Animal Management Information .....	36
4.7 Calibration of the Sensors and Verification of the Fan Airflow Rate .....	37
4.7.1 Calibration of the Sensors .....	37
4.7.2 Verification of the Fan Air flow Rate.....	37
5. RESULTS AND DISCUSSION .....	40
5.1 Diurnal Odour and Gas Concentration and Emission Profiles .....	40
5.1.1 Diurnal Odour and Gas Concentration and Emission Profiles in August .....	40
5.1.1.1 Odour Concentration and Emission .....	40
5.1.1.2 Odour Concentration and Emission Statistical Analysis .....	43
5.1.1.3 Gas Concentration and Emission and Statistical Analysis.....	44
5.1.2 Diurnal Odour and Gas Concentration and Emission Profiles in October .....	49
5.1.2.1 Odour Concentration and Emission .....	49
5.1.2.2 Odour Concentration and Emission Statistical Analysis .....	51
5.1.2.3 Gas Concentration and Emission and Statistical Analysis.....	53
5.1.3 Diurnal Odour and Gas Concentration and Emission Profiles in February .....	58
5.1.3.1 Odour Concentration and Emission .....	58
5.1.3.2 Odour Concentration and Emission Statistical Analysis .....	60
5.1.3.3 Gas Concentration and Emission and Statistical Analysis.....	61
5.1.4 Summary of Diurnal Odour and Gas Concentration and Emission.....	65
5.2 Seasonal Odour and Gas Concentration and Emission Profiles .....	73
5.2.1 Seasonal Odour and Gas Concentration and Emission .....	73
5.2.2 Seasonal Odour and Gas Concentration and Emission Statistical Analysis.....	82
5.2.3 Summary of Seasonal Odour and Gas Concentration and Emission.....	84
5.3 Modelling Diurnal and Seasonal Odour and Gas Concentration and Emission .....	86
5.3.2 Odour and Gas Concentration and Emission Modelling.....	86
5.3.3 Summary of Odour and Gas Concentration and Emission Modelling .....	93
6. CONCLUSIONS AND RECOMMENDATIONS .....	96
6.1 Summary and Conclusions .....	97
6.1.1 Diurnal Odour and Gas Concentration and Emission .....	97
6.1.2 Seasonal Odour and Gas Concentration and Emission .....	99
6.1.3 Odour and Gas Concentration and Emission Modelling.....	99
6.2 Recommendations for Further Study.....	100
REFERENCES.....	102
APPENDIX A SWINE ENVIRONMENT MEASURING SYSTEM .....	109
APPENDIX B CALIBRATION OF THE SENSORS.....	110
B.1 Calibration of the Temperature Sensors.....	110



B.2 Calibration of the Relative Humidity Sensors .....	111
B.3 Calibration of the Pressure Transducers .....	113
B.4 Calibration of the Hall Fan Sensors .....	114
APPENDIX C    VERIFICATION OF THE FAN AIR FLOW RATE.....	115
APPENDIX D    ODOUR AND GAS DATA STATISTICAL ANALYSIS .....	117
D.1 Diurnal Odour and Gas Concentration and Emission Statistical Analysis .....	117
D.1.1 Statistical Analysis Results for Diurnal Odour and Gas Concentrations and Emissions in August.....	118
D.1.2 Statistical Analysis Results for Diurnal Odour and Gas Concentrations and Emissions in October.....	120
D.1.3 Statistical Analysis Results for Diurnal Odour and Gas Concentrations and Emissions in February .....	123
D.1.4 Summary of Means (S.D.) of Diurnal Measured Variables .....	126
D.2 Seasonal Odour and Gas Concentration and Emission Statistical Analysis .....	127

## LIST OF TABLES

Table 4.1 Saskatoon climate information (World Meteorological Organization). .....	20
Table 4.2 Detailed layout of the 2×8 strip-block plot design.* .....	21
Table 4.3 Source of variation and degrees of freedom for the strip-block experiment. ....	22
Table 4.4 Source of variation and degrees of freedom for the repeated measurement experiment.....	25
Table 5.1 Three-hour means, S.D. and ranges of measured variables in August. ....	43
Table 5.2 Hourly means, S.D. and ranges of measured variables in August.* .....	48
Table 5.3 Three-hour means, S.D. and ranges of measured variables in October. ....	52
Table 5.4 Hourly means, S.D. and ranges of measured variables in October.* .....	57
Table 5.5 Three-hour means, S.D. and ranges of measured variables in February. ....	60
Table 5.6 Hourly means, S.D. and range of measured variables in February.....	64
Table 5.7 Mean comparison of odor and gas concentration and emission during three measurement seasons. ....	70
Table 5.8 Effects of ‘Flooring’ and ‘Diurnal’ factors on the odour and gas concentration and emission during three sampling seasons. ....	71
Table 5.9 Pearson correlation matrix coefficients (r) for odour and gas concentrations under different weather conditions.....	72
Table 5.10-1 Average and standard deviation (S.D.) of odour concentrations and emissions from two types of rooms in each sampling month. ....	74
Table 5.10-2 Average and standard deviation (S.D.) of gas concentrations and emissions from two types of rooms in each sampling month. ....	75
Table 5.11 ‘Flooring’ and ‘Month’ factors on seasonal odour and gas concentrations and emissions. ....	85
Table 5.12 SAS results of odour and gas models for the partially slatted flooring system.	86
Table 5.13 SAS results of odour and gas models for the fully slatted flooring system. ....	90
Table 5.14 Effects of input factors on odour and gas models.* .....	94
Table B.1 The calibration results of the temperature sensors. ....	111
Table B.2 The calibration results of the relative humidity sensors.....	112
Table B.3 The calibration results of the pressure transducer. ....	113
Table C.1 Airflow rates of the three tested fans using fan manufacturer data.....	115
Table C.2 Airflow rates of the three tested fans using field calibration data.....	115
Table C.3 Airflow rates and environment parameters on single-speed fan-1.....	116
Table C.4 Airflow rates and environment parameters on single-speed fan-2.....	116
Table D.1 ANOVA table for odour concentration in August. ....	118
Table D.2 ANOVA table for odour emission in August.....	118
Table D.3 ANOVA table for NH <sub>3</sub> concentration in August. ....	118

Table D.4 ANOVA table for H <sub>2</sub> S concentration in August.....	119
Table D.5 ANOVA table for CO <sub>2</sub> concentration in August.....	119
Table D.6 ANOVA table for NH <sub>3</sub> emission in August.....	119
Table D.7 ANOVA table for H <sub>2</sub> S emission in August.....	120
Table D.8 ANOVA table for CO <sub>2</sub> emission in August.....	120
Table D.9 ANOVA table for odour concentration in October.....	120
Table D.10 ANOVA table for odour emission in October.....	121
Table D.11 ANOVA table for NH <sub>3</sub> concentration in October.....	121
Table D.12 ANOVA table for H <sub>2</sub> S concentration in October.....	121
Table D.13 ANOVA table for CO <sub>2</sub> concentration in October.....	122
Table D.14 ANOVA table for NH <sub>3</sub> emission in October.....	122
Table D.15 ANOVA table for H <sub>2</sub> S emission in October.....	122
Table D.16 ANOVA table for CO <sub>2</sub> emission in October.....	123
Table D.17 ANOVA table for odour concentration in February.....	123
Table D.18 ANOVA table for odour emission in February.....	123
Table D.19 ANOVA table for NH <sub>3</sub> concentration in February.....	124
Table D.20 ANOVA table for H <sub>2</sub> S concentrations in February.....	124
Table D.21 ANOVA table for CO <sub>2</sub> concentrations in February.....	124
Table D.22 ANOVA table for NH <sub>3</sub> emission in February.....	125
Table D.23 ANOVA table for H <sub>2</sub> S emissions in February.....	125
Table D.24 ANOVA table for CO <sub>2</sub> emissions in February.....	125
Table D.25 Summary of means and standard deviations (S.D.) of diurnal measured variables during three measurement seasons.....	126
Table D.26 ANOVA table for seasonal odour concentrations in four pig rooms.....	127
Table D.27 ANOVA table for seasonal odour emissions in four pig rooms.....	128
Table D.28 ANOVA table for seasonal NH <sub>3</sub> concentrations in four pig rooms.....	128
Table D.29 ANOVA table for seasonal NH <sub>3</sub> emissions in four pig rooms.....	128
Table D.30 ANOVA table for seasonal H <sub>2</sub> S concentrations in four pig rooms.....	129
Table D.31 ANOVA table for seasonal H <sub>2</sub> S emissions in four pig rooms.....	129
Table D.32 ANOVA table for seasonal CO <sub>2</sub> concentrations in four pig rooms.....	129
Table D.33 ANOVA table for seasonal CO <sub>2</sub> emissions in four pig rooms.....	130

## LIST OF FIGURES

Figure 4.1 Layout of the grower/finisher rooms .....	18
Figure 4.2 Layout (top view) of the swine room .....	19
Figure 4.3 Measurement locations in an experimental room.....	29
Figure 4.4 Schematic RPM phase-locked loop circuit.....	33
Figure 4.5 Embedded microprocessor-based environment measuring system .....	35
Figure 4.6 Picture of part of environment measuring system. ....	36
Figure 4.7 Model TR36D01 exhaust fan .....	38
Figure 4.8 Measurement points in the plane .....	39
Figure 5.1 Odour concentrations, emissions, room and ambient temperatures, and ventilation rates for August 2 to 4, 2004.....	41
Figure 5.2 NH <sub>3</sub> concentrations and emissions for August 2 to 4, 2004.....	45
Figure 5.3 H <sub>2</sub> S concentrations and emissions for August 2 to 4, 2004.....	46
Figure 5.4 CO <sub>2</sub> concentrations and emissions for August 2 to 4, 2004.....	47
Figure 5.5 Odour concentrations, emissions, room and ambient temperature and ventilation rates for October 17 to 18 and 25 to 26, 2004.....	50
Figure 5.6 NH <sub>3</sub> concentrations and emissions for October 17 to 18 and 25 to 26, 2004.....	53
Figure 5.7 H <sub>2</sub> S concentrations and emissions for October 17 to 18 and 25 to 26, 2004.....	55
Figure 5.8 CO <sub>2</sub> concentrations and emissions for October 17 to 18 and 25 to 26, 2004.....	56
Figure 5.9 Odour concentrations, emissions, room and ambient temperature and ventilation rate for February 13 to 15, 2005.....	59
Figure 5.10 NH <sub>3</sub> concentrations and emissions for February 13 to 15, 2005.....	61
Figure 5.11 H <sub>2</sub> S concentrations and emissions for February 13 to 15, 2005.....	62
Figure 5.12 CO <sub>2</sub> concentrations and emissions for February 13 to 15, 2005.....	63
Figure 5.13 The means of diurnal odour concentrations during three measurement months.....	65
Figure 5.14 The means of diurnal Odour emissions during three measurement months.....	65
Figure 5.15 The means of diurnal NH <sub>3</sub> concentrations during three measurement months.....	66
Figure 5.16 The means of diurnal NH <sub>3</sub> emissions during three measurement months.....	66
Figure 5.17 The means of diurnal H <sub>2</sub> S concentrations during three measurement months.....	66
Figure 5.18 The means of diurnal H <sub>2</sub> S emissions during three measurement months.....	67
Figure 5.19 The means of diurnal CO <sub>2</sub> concentrations during three measurement months.....	67
Figure 5.20 The means of diurnal CO <sub>2</sub> emissions during three measurement months.....	67

Figure 5.21 Seasonal room and ambient temperatures and ventilation rates in four rooms. .....	76
Figure 5.22 Seasonal variations of odour concentrations and emissions in four rooms.	77
Figure 5.23 Seasonal variations of NH <sub>3</sub> concentrations and emissions in four rooms. ...	79
Figure 5.24 Seasonal variations of H <sub>2</sub> S concentrations and emissions in four rooms. ...	80
Figure 5.25 Seasonal variations of CO <sub>2</sub> concentrations and emissions in four rooms. ..	81
Figure 5.26 The measured vs. predicted odour and gas concentration and emission for the partially-slatted flooring system (X axis indicates No. of samples). ....	89
Figure 5.27 The measured vs. predicted odour and gas concentration and emission for the fully-slatted flooring system (X axis indicates No. of samples). ....	93
Figure A.1 The environment measuring system made and tested in the lab. ....	109
Figure A.2 The Measuring system installed in the swine barn. ....	109
Figure B.1 The temperature sensors. ....	110
Figure B.2 Calibration of the temperature sensors using the angelantoni climatic system. .....	110
Figure B.3 The relative humidity sensors covered with PVC covers. ....	111
Figure B.4 Calibration of the relative humidity sensors using the Hydro-MZ dew point monitor. ....	112
Figure B.5 The pressure transducers and calibration of the sensors using the OMEGA pressure meter and pump. ....	113
Figure B.6 Calibration of the Hall fan sensors using the 50-MHz pulse generator and 1.3-GHz frequency counter. ....	114
Figure C.1 Results of airflow rates on three variable-speed fans. ....	116

## 1. INTRODUCTION

Ammonia (NH<sub>3</sub>), hydrogen sulfide (H<sub>2</sub>S), carbon dioxide (CO<sub>2</sub>) and odorous gaseous compounds are produced by livestock facilities. These gases may affect the health of animals and nearby residents, deteriorate equipment and buildings, and potentially cause damage to the environment (Kurvits and Marta, 1998; Ni et al., 2002). With the increasing number of disputes and lawsuits against intensive swine operations, odour and gas emissions from swine barns have become a major issue for the swine industry, which is an important sector of the agricultural economy in Saskatchewan, Canada.

Over the last decade, some abatement methods and strategies have been developed and utilized to alleviate odour and gas problems. However, few of these technologies are adopted by swine producers (Zhou and Zhang, 2003). A simple approach that is widely practiced for addressing odour and gas matters is to maintain adequate setback distances between the swine operation and the neighbouring residences. At present, some of the existing setback distance guidelines in Europe, Australia, and the U.S.A are all based on experience (Schauberger and Piringer, 1997; Jacobson et al., 2000; Lim, et al., 2000; Guo et al., 2004). However, it should be noted that it is almost impossible and impractical to generate setback distances merely based on experiments since every odour and gas source is different, every surrounding area is different, and weather conditions change constantly. Therefore, in order to determine reasonable science-based

setback distances, air dispersion models should be used to estimate downwind odour and gas concentrations from livestock operations. A good prediction of downwind odour and gas using air dispersion models relies largely on source emission rate information which is highly variable with diurnal and seasonal variations, building characteristics, ventilation rate, animal size and density, weather conditions and manure handling systems.

Although source odour and gas emission rates are basic and important input data for air dispersion modeling, none of the existing models consider the diurnal, seasonal and climate variations of the odour and gas emission rates from livestock operations. Some researchers simply use the mean or geometric mean of the data measured randomly during the daytime at any time of the year as the emission rates to be used for setback determination (Jacobson et al., 2000). Using randomly measured emission rates for setback distance calculation may result in great uncertainties. Thus, it is vital to monitor the diurnal and seasonal odour and gas emission profiles for determining setback distances and providing useful information to improve setback guidelines. Furthermore, identification of the diurnal and seasonal odour and gas emission profiles will help to develop odour abatement strategies targeting high odour emission periods.

The purpose of the present project is to determine and model odour and gas concentration and emissions from swine operations in Saskatchewan as affected by time of day, season, type of flooring system, and environmental parameters.

## **2. LITERATURE REVIEW**

This chapter summarizes previous findings on odour and gas concentration and emission from swine production facilities. It is divided into three sections that respectively focus on diurnal and seasonal odour emission measurement, odour and gas measurement, and ventilation rate measurement.

### **2.1 Diurnal and Seasonal Odour Emission Measurement**

There are three papers dealing with diurnal and seasonal odour emission measurements. Schauburger et al. (1999) developed a simple steady-state heat balance model to calculate the diurnal and annual variation of odour emissions and gave approximate emission results which showed a distinct diurnal and seasonal variation of the odour concentration. They reported that the annual variation of the odour concentration of the outlet air calculated for a pig fattening unit was between 687 and 3226 OU m<sup>-3</sup> (Odour units per cubic metre (CEN, 1999)). They also stated that during a clear-sky summer period the model predicted the night time odour concentration of about 4.6 times the daytime concentrations due to the large variability of the ventilation rates. In the conclusions of this paper, it was suggested that the annual and diurnal variation of the odour release should be taken into account for dispersion models in order to improve the calculation of odour concentrations, as well as long-term measurements of the odour



emissions from animal houses were necessary. However, Schaubberger et al. (1999) did not make any attempt to measure odour concentrations and emissions from the livestock buildings and demonstrate the validity of their model.

Hartung et al. (1998) studied the diurnal course of the odour emissions from two piggeries, one dairy house and two biofilters. Odour samples were taken every two hours between 0700 and 1900 h and for the remaining time every three hours. A total of four 24 hr measurements were conducted. It was found that: (1) odour emissions from swine buildings had a pronounced diurnal pattern; (2) no clear odour release pattern was observed for the dairy house, and (3) the odour reduction of biofilters was mainly affected by the odour concentration in the waste air. Although the authors mentioned that at least four to six odour samples per day needed to be monitored under summer and winter climate conditions, they only took samples during the summer period. It could be inferred that winter experiments might reveal different results of the diurnal variations for odour emissions from different livestock facilities.

Zhu et al. (2000) monitored seven different animal facilities to determine daily variations in emissions of odour, ammonia, and hydrogen sulfide. In the experiment, air samples from five different swine buildings (finishing A, finishing B, gestation, farrowing and nursery), one dairy barn and one broiler barn were collected every two hours over a 12-hour period during the day for odour and gas measurement. It was found that a nursery building had the highest emission rates for odour and hydrogen sulphide (maximum:  $50 \text{ OU m}^{-2}\text{s}^{-1}$  and  $140 \mu\text{g m}^{-2}\text{s}^{-1}$ , respectively) and a naturally ventilated

swine finishing building had the highest ammonia emissions (maximum:  $170 \mu\text{g m}^{-2} \text{s}^{-1}$ ) when the building was running at full capacity. However, this study had some limitations. First, in every animal building, only one 12- hour measurement was conducted. According to statistical principles (Townend, 2002), lacking replications in statistical model analysis would cause the results to be uncertain. Second, data were collected for just one month from the middle of September to the middle of October so it is unknown if some of the results could be applied to other seasons.

## **2.2 Odour Concentration and Emission Measurement**

### **2.2.1 Odour Measurement Method**

Currently, the most common method for measuring odour is to use an olfactometer (Janni et al., 2002). This is a psychophysical method based upon the olfactory responses of individuals sniffing diluted odour samples presented by an olfactometer to determine odour concentration or intensity. Specifically, an olfactometer presents three air streams to the panellists. One of the air streams is a mixture of non-odorous air and an extremely small amount of odorous air from a sample bag. The other two air streams are only non-odorous air. The panellists sniff each air stream and identify which air stream is different than the other two non-odorous air streams. Then the amount of odorous air is increased until 50% of the panellists correctly recognize the odorous air stream. The detection threshold is the flow rate of the non-odorous airflow rate divided by that of the odorous air when the panellists identify different air streams. The geometric mean of the panellists is taken as the odour concentration or odour detection threshold (OU: odour

units). The odour concentration of a sample is often expressed as odour units per cubic meter ( $\text{OU m}^{-3}$ ) for calculation of odour emission rate (CEN, 1999).

During the odour measurement, the retrospective screening is carried out according to the European Standard for determining odour concentration by dynamic olfactometer (CEN 1999). Screening of odour panellists is performed on all of the assessors according to the European Standard (CEN 1999). Two panel selection criteria are: 1) the geometric mean of the individual threshold estimates expressed in mass concentration of the n-butanol gas had to fall between 20 to 80 ppb, and 2) the antilog of the standard deviation calculated from the logarithms of the individual threshold estimates, expressed in mass concentration of n-butanol gas, had to be less than 2.3 to ensure the consistency requirement. Although olfactometry is one of the most accepted means for evaluating odour samples, its measurement uncertainty is very large. Clanton et al. (1999) studied dynamic olfactometry variability in determining odour concentrations and found that the whole-panel variation ranged from a 22% to 50% difference in reported odour units for the same sample, and using two different airflow rate calibrations resulted in a 9% to 28% difference in odour concentrations for the same sample.

### **2.2.2 Previous Odour Concentration and Emission Research**

To allow comparison with other research results, odour emissions are often presented in two ways: 1) emissions are expressed on the weight and number of animals basis by dividing the total emissions by the animal units (1 AU = 500 kg live weight), and 2)

emissions are expressed on the building floor area basis by dividing the total emissions by the total floor area of the room.

Jacobson et al. (1998) measured odour and gas reductions from sprinkling soybean oil in pig nurseries located in Minnesota between December and March. The average weight of pigs was 7-16 kg for two six-week growth cycles. It was observed that the mean odour concentrations of ventilation air samples taken in the control and treatment rooms were 461 and 251 OU m<sup>-3</sup>, respectively. However, the odour emissions were not reported in this study.

Heber et al. (1998) monitored odour emissions from four mechanically ventilated swine finishing houses between April and August. The buildings had long-term manure storage beneath fully slatted floors. The mean odour concentration of 109 measurements was 142 OU m<sup>-3</sup>, and the mean odour emission rate was 36 OU AU<sup>-1</sup> s<sup>-1</sup>. The geometric mean building odour emission rate was 3,990 OU/s, or 5.0 OU m<sup>-2</sup> s<sup>-1</sup>.

Lim et al. (2001) conducted research on odour emission rates from two commercial swine nurseries in Indiana during the months of March, April, and May. The nurseries housing 94 to 250 pigs were mechanically ventilated with long-term manure storage pits under wire floors. Five sampling visits were made to each nursery and nine or ten air samples were collected during each visit. They found that the mean odour emission rates of two nurseries were 18.2 and 62.5 OU AU<sup>-1</sup> s<sup>-1</sup> (1.1 and 2.7 OU m<sup>-2</sup> s<sup>-1</sup>) respectively,

as well as the mean odour concentrations of ambient and ventilation exhaust air were 18 and 199 OU/m<sup>3</sup> respectively.

Schmidt et al. (2002) studied the odour and gas emission rates from three naturally ventilated animal buildings (swine, dairy, and turkey). Ammonia and hydrogen sulfide were monitored continuously for a 10-day period during the summer and a 10-day period in the winter; while grab samples of odour were taken once during the summer measuring period. It was observed that the odour emission rate from the swine barn was 55 OU AU<sup>-1</sup> s<sup>-1</sup> (15 OU m<sup>-2</sup> s<sup>-1</sup>).

Gay et al. (2003) observed odour levels emitted from more than 200 animal housing facilities in Minnesota. The odour emissions from naturally and mechanically ventilated finishing pig barns ranged from 0.071 to 745 OU m<sup>-2</sup> s<sup>-1</sup> with a geometric mean of 6.68 OU m<sup>-2</sup> s<sup>-1</sup>. They stated that odour emissions from swine facilities were generally higher than the emissions from beef, dairy, or poultry facilities and were highly variable in accordance with some observations due to the differences between sampling sites, seasons, ambient air temperature, and the methods used for estimating building ventilation rates.

Hayes et al. (2003) investigated odour emission rates at three pig units: one was at the University College Dublin Research Farm with 72 finishing pigs; the other two were commercial scale integrated operations with 300 and 1300 sows from birth to finishing. They reported that the minimum odour emission rate in pig housing was 4.6 OU pig<sup>-1</sup> s<sup>-1</sup>

for first stage weaners and the maximum was 66.4 OU pig<sup>-1</sup> s<sup>-1</sup> for farrowing houses. The mean odour emission rates for finishing pigs ranged from 6.0 to 10.7 OU pig<sup>-1</sup> s<sup>-1</sup>.

Study on measurements of odour and hydrogen sulfide emissions from ten swine farms in Canada by Zhou and Zhang (2003) showed that the average odour concentrations from barn exhaust ranged from 131 to 1842 OU m<sup>-3</sup> and odour emissions from 12 to 39 OU m<sup>-2</sup> s<sup>-1</sup>. No apparent correlations were found between the odour concentration and the general farm characteristics, such as years of operation, type of operation, ventilation system, and manure handling system.

## **2.3 Gas Concentration and Emission Measurement**

### **2.3.1 Gas Measurement Method**

Many measurement methods have been employed to measure ammonia, hydrogen sulfide and carbon dioxide concentrations from livestock facilities (Janni et al., 2002). To measure ammonia concentrations, the most common methods include the pH test paper method, gas detection tubes, Fourier transform infrared spectroscopy, non-dispersive infrared gas analyzer, ultraviolet differential optical absorption spectroscopy, and chemiluminescence analyzing. To measure hydrogen sulfide concentrations, a portable electronic device, Jerome™ meter (JEROME 631-X, Arizona Instrument Co., Phoenix, AZ, USA) or a pulsed-fluorescence sulphur dioxide analyzer is often used. To measure carbon dioxide concentrations, a gas chromatograph is generally considered a measuring device.

### **2.3.2 Previous Gas Concentration and Emission Research**

Aarnink et al. (1995) studied the ammonia emission of growing pigs in buildings with partially slatted floors to determine its pattern and variation under practical conditions. Five groups of 40 weaned piglets and three groups of 36 fattening pigs were used. The results showed the mean ammonia emission was  $0.87 \text{ g d}^{-1}$  per rearing pig (range between groups  $0.70\text{-}1.20 \text{ g d}^{-1}$ ) and  $5.8 \text{ g d}^{-1}$  per fattening pig (range between groups  $5.7\text{-}5.9 \text{ g d}^{-1}$ ), and a mean daily increase in emission of  $30 \text{ mg d}^{-1}$  per rearing pig and of  $85 \text{ mg d}^{-1}$  per fattening pig. It was also investigated that the ammonia emission was higher during the day than during the night, by 10% for piglets and 7% for fatteners. The emission for rearing pigs was 56% higher during the summer period than the other periods of the year, but this was not found in fatteners.

Groot Koerkamp et al. (1998) studied ammonia emissions from 14 livestock housing types for cattle, pigs and poultry in England, The Netherlands, Denmark and Germany. Concentrations of ammonia were measured at seven locations inside and one location outside in four replicates of each housing type over 24 h under summer and winter conditions. It was found that mean ammonia concentrations were between 5 and 18 ppm in the pig houses as well as ammonia emission rates from pig houses (sows, weaners, and finishers) varied between 22 and  $1298 \text{ mg h}^{-1}$  per animal or 649 and  $3751 \text{ mg h}^{-1}$  (500 kg) live weight. The authors mentioned that these emissions should be used carefully even though they were based upon a very large survey because of large variation between countries, between commercial houses and between seasons. They

also stated that the possible disadvantage of the short measuring period (24 h) in each house was probably well overcome by the number of repetitions of measurements in four replicates of each housing type under summer and winter conditions when the measured results compared with the Dutch data.

Ni et al. (2000a) measured NH<sub>3</sub> emission rate from a finishing swine building. A total of 88 days of data was obtained by taking continuous measurements during warm weather from June 26 with 887 19.4 kg-pigs to September 25 with 874 83.1 kg-pigs. The mean NH<sub>3</sub> concentration was 3.9±0.3 mg m<sup>-3</sup> and ranged from 1.9 to 7.4 mg m<sup>-3</sup>. The average daily mean building NH<sub>3</sub> emission was 11.2±1 kg d<sup>-1</sup> (equivalent to 145±10 g AU<sup>-1</sup>d<sup>-1</sup>). The emission rate per AU was higher than other reported values probably because of warm temperatures and high ventilation rates, and was correlated to total pig weight ( $r^2 = 0.49$ ). The low value indicated that there was no significant relationship between the NH<sub>3</sub> emission and the total pig weight.

Ni et al. (2002) also reported hydrogen sulfide emission rates from two 1000-head pig-finishing buildings in Illinois, USA. The emissions were monitored with a high-frequency measurement system between March and September in 1997. Air sample streams were continuously taken from pit fans, wall fans and pit headspaces. Average building H<sub>2</sub>S emission rate was 591 g d<sup>-1</sup> or 740 mg m<sup>-2</sup> d<sup>-1</sup> of pit surface area or 6.3 g AU<sup>-1</sup> d<sup>-1</sup>. It was observed that hydrogen sulfide emission rate increased with temperature and building ventilation rate.



Zhu et al. (1999) measured the ammonia and hydrogen sulfide emissions at seven different animal facilities from the middle of September to the middle of October in 1998. They reported that the nursery building had the highest hydrogen sulfide emission rates ( $140 \mu\text{g m}^{-2} \text{s}^{-1}$ ) and the highest ammonia emissions ( $170 \mu\text{g m}^{-2} \text{s}^{-1}$ ) occurred in the naturally ventilated swine finishing building. They also found that there was no significant difference in average ammonia and hydrogen sulfide concentrations over the 12-h sampling period for all the animal facilities.

Zhou and Zhang (2003) declared that the average H<sub>2</sub>S concentration and emission rate spanned from 148 to 927 ppb and from 6.4 to 25.1 mg m<sup>-2</sup> s<sup>-1</sup> of floor area, respectively, on all six farms.

Osada et al. (1998) measured CO<sub>2</sub> from pig units. Carbon dioxide presented a typical diurnal fluctuation pattern. At a constant indoor temperature of around 17 °C, the CO<sub>2</sub> emissions observed at the peak hours (1300-1400 h) was twice as high as that observed around 0600 h. The CO<sub>2</sub> emission from pig units during a full 8-week finishing period was evaluated to 5540 g pig<sup>-1</sup>. It was also observed that the increase in CO<sub>2</sub> production might also have some relationship with the pig excreting activities.

Ni et al. (2000b) evaluated the relative contribution of under-floor 2.4-m deep manure storage pits to the global release rates of CO<sub>2</sub>, H<sub>2</sub>S, and NH<sub>3</sub> from two commercial swine finisher barns. In the first test, a new manure additive was applied in the pit to reduce gas and odour emission. The pit ventilation mode was employed and the building

was heated for about 1 h. In the second test, the pit did not receive the additive application. The tunnel ventilation mode was used and the building was heated for about 2 h. It was observed that the maximum CO<sub>2</sub> release rates after heating were 3.4 kg h<sup>-1</sup> in the first test and 7.0 kg h<sup>-1</sup> in the second test, as well as the CO<sub>2</sub> unit emission rates were within the range of 0.8 to 118.4 g m<sup>-2</sup> h<sup>-1</sup>.

## **2.4 Ventilation Rate Measurement Method**

Odour and gas emissions are usually calculated by multiplying ventilation rates by the concentration of an odour and gas in the exhaust airflow stream (Smith and Dalton, 1999). The existing methods of ventilation rate measurement include the fan testing report method, velocity traverse method, carbon dioxide mass balance method, tracer gas method and heat balance method. However, it is very difficult to measure and obtain an accurate ventilation rate. The reason could be due to the fact that the ventilation rate is affected by a variety of factors including diurnal climate variations and animal activity causing frequent changing of fan running conditions, dust accumulation on fan shutters and blades, loose fan belts, changes in building static pressure, and changing of power supply to the fans (Bicudo et al., 2002). Up to now, the use of static pressure readings and the fan testing report method for mechanically ventilated buildings and carbon dioxide measurements for naturally ventilated or “hybrid” buildings can provide relatively accurate estimates of ventilation rate (Gay et al., 2003).

The fan testing report method is to estimate the airflow rates of all the fans by measuring the fan speeds and the static pressure of the room. Using the fan testing report obtained from the fan testing organizations or fan manufacturers and the measured fan speed and room static pressure, the air flow rates of each fan can be determined.

The carbon dioxide mass balance method entails estimating the carbon dioxide production rate from the pigs and measuring CO<sub>2</sub> concentrations of the incoming and exhausting air. Although this technique is less accurate due to the error in CO<sub>2</sub> production rate estimation, it has the advantage of being applicable in principle to ventilated houses. The ventilation rate was given by (Albright, 1990),

$$V = P / ((C_{out} - C_{in}) \times 10^{-6}) \quad (2.1)$$

where  $V$  is the ventilation rate, m<sup>3</sup> h<sup>-1</sup>;  $P$  is the carbon dioxide production rate, m<sup>3</sup> h<sup>-1</sup>;  $C_{out}$  is the outside carbon dioxide concentration, ppm; and  $C_{in}$  is the inside carbon dioxide concentration, ppm.

## 2.5 Summary of Literature Review

In the literature, very few research projects were related to diurnal and seasonal odour emission measurements as well as odour and gas emission prediction models. Specifically, (1) few projects were conducted to monitor diurnal and seasonal odour concentrations and emissions from swine production facilities; (2) little has been done to quantify the different of odour and gas concentrations and emissions for two different

flooring systems (fully slatted floors and partially slatted floors) in confined swine rooms, and (3) little has been done to develop odour concentration and emission models.

On the other hand, odour and gas emission results from numerous experiments for different swine production facilities were widely discussed and presented. The large variability in concentration and emission data found in the literature clearly indicates that there exists a need to better determine the relative contributions of the different stages of swine production to the odour and gas concentrations and emissions. Additionally, it is considered that the area of grower/finisher pigs is the biggest in the experiment barn and grower/finisher pigs consume more than 60% of feed for all the pigs. Therefore, the purpose of the present project is to monitor and model diurnal and seasonal odour and gas emission profiles for swine grower/finisher rooms with partially and fully slatted floors.

### **3. OBJECTIVES**

The over-arching goal of this project is to monitor and model diurnal and seasonal odour and gas emissions from swine grower/finisher rooms in Saskatchewan.

The first objective is to monitor diurnal profiles of odour and gas (ammonia, hydrogen sulfide, and carbon dioxide) concentrations and emissions (OGCER) for two different flooring systems (fully slatted floor and partially slatted floor) of confined swine finishing rooms, as well as to determine relationships among odour, ammonia, hydrogen sulfide, and carbon dioxide concentrations under different weather conditions.

The second objective is to measure seasonal OGCER to identify the relationship between OGCER and inside and ambient temperatures, the age and weight of pigs, and different flooring systems of swine rooms.

The third objective is to develop mathematical models for predicting OGCER as functions of diurnal, seasonal, and climate variations, ventilation rates, and animal units (representing pig size and density), etc. The result could provide the scientific basis for measuring, adjusting, and estimating OGCER at various times for swine grower/finisher facilities in Saskatchewan.

## **4. MATERIALS AND METHODS**

This research project was conducted at the PSC (Prairie Swine Centre) Elstow Research Farm Inc., 50 km away from Saskatoon, Saskatchewan, from August 2004 to July 2005.

### **4.1 Description of Experimental Swine Rooms**

The PSC Elstow Research Farm consists of 16.2 hectares (40 acres) with an approximately square shape (408 m or 1340 ft per side). It included the main 600-sow farrow-to-finish barn, the earthen manure storage with a 400-day capacity, the feed mill with a capacity to produce 6000 tonnes of feed per year and the manager's residence (Prairie Swine Center Inc., 2005).

Odour and gas concentration and emission measurements were conducted in four identical mechanically ventilated growing/finishing rooms (rooms 6, 9, 10, and 11), which are controlled with integrated environmental control systems (Model-Supra, Phason Inc., Winnipeg, Manitoba, Canada). Each room is 19.7 m x 12.7 m with a flooring surface area of 250.2 m<sup>2</sup>, and has 16 pens, 8 on each side of a central alleyway. The pens are 5.8 m long by 2.4 m wide providing 0.88 m<sup>2</sup> per pig (Figure 4.1).

Room 6 is located on the opposite side of rooms 9, 10 and 11. Room 9 is next to room 10 and there is a small loading room (‘GL’) between rooms 10 and room 11. Rooms 6 and 9 have partially (37%) slatted floorings and rooms 10 and 11 have fully slatted floorings.

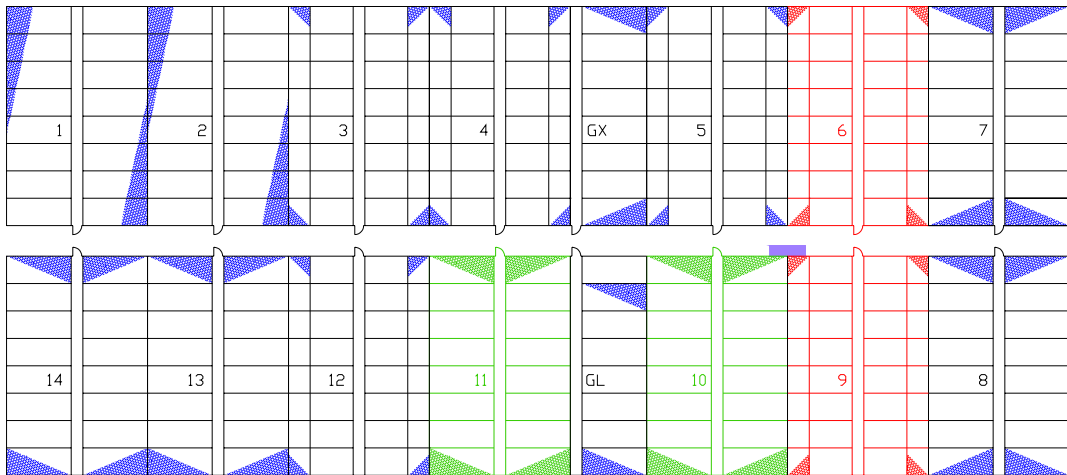

Figure 4.1 Layout of the grower/finisher rooms (blue lines indicate slatted flooring; red lines present rooms 6 and 9 having partially slatted floorings; green lines present rooms 10 and 11 having fully slatted floorings; small purple rectangle indicates the location of the environment measuring system in the hallway).

In two growing/finishing rooms, manure gutters were designed to allow collection of slurry on a pen by pen basis. There are two individual isolated gutters under each of the 16 pens in these two rooms. Concrete was added to the gutter bottoms to create a “Y” cross-sectional shape for more complete clean out.

Figure 4.2 shows the layout (top view) of the swine growing/finishing room. The fresh air is supplied to the experiment room from the attic/ceiling.

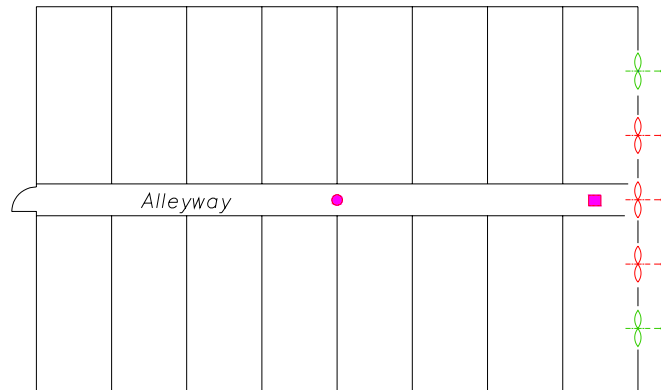





Figure 4.2 Layout (top view) of the swine room (exhaust fan  ; odour and gas outlet sampling location ; inlet gas sampling location .

The monitoring of diurnal odour and gas concentration and emission has been done in rooms 9 and 10 while the measurements of seasonal odour and gas emission rates have been in all four rooms 6, 9, 10 and 11.

## 4.2 Odour and Gas Concentration and Emission Measurement Experiment Design

### 4.2.1 Diurnal Measurement Experiment Design and Statistical Analysis

The purpose of monitoring diurnal odour and gas concentration and emission was to obtain diurnal odour and gas concentration and emission profiles during different periods. Saskatoon climate information based on monthly averages for the 30-year period 1971-2000 is given in Table 4.1.



Table 4.1 Saskatoon climate information (World Meteorological Organization).

Month	Mean Temperature ( °C )		
	Daily Minimum	Daily Maximum	Monthly Average
Jan	-22.3	-11.8	-17.1
Feb	-18.2	-7.8	-13.0
Mar	-10.9	-0.7	-5.8
Apr	-1.9	10.6	4.4
May	4.5	18.4	11.5
Jun	9.4	22.6	16.0
Jul	11.4	24.9	18.2
Aug	10.2	24.4	17.3
Sep	4.4	18	11.2
Oct	-1.9	10.8	4.5
Nov	-10.9	-1.5	-6.2
Dec	-19.4	-9.2	-14.3

The climate information shown in Table 4.1 could be separated into three typical weather conditions: warm weather (May, Jun, Jul, Aug and Sep), mild weather (Apr, Oct) and cold weather (Jan, Feb, Mar, Nov and Dec). Thus, the diurnal measurements were conducted three times (once a month in August, October, and February) in rooms 9 and 10 under the three typical weather conditions.

In order to meet statistic validity requirements, sufficient repetition and replication are necessary (Townend, 2002). It should also be considered that odour and gas sampling and measuring are time consuming and costly (over \$ 100 per sample). Hence, it was decided that a strip-block design would be appropriate for investigating the influence of different flooring systems, air temperature, ventilation rate, pig size and density, and swine management, etc. on the daily variations of odour and gas concentrations and emissions from the two types of swine rooms. In the strip-block arrangement, the experiment involves two factors, the '*Flooring*' factor and the '*Diurnal*' factor. The

‘Flooring’ factor was defined as a main-plot factor with two levels: fully slatted flooring system and partially slatted flooring system. The ‘Diurnal’ factor was treated as a function of ventilation rate, outside and room temperature, and swine management during different intervals per measurement day and was assigned to the sub-units (sub-plots) in the whole-plot. It was decided that odour and H<sub>2</sub>S were measured once every three hours by continuously sampling the exhaust air to air sampling bags; while NH<sub>3</sub> and CO<sub>2</sub> were measured hourly. Therefore, the ‘Diurnal’ factor had eight levels for odour and H<sub>2</sub>S concentrations and emissions, as well as twenty-four levels for NH<sub>3</sub> and CO<sub>2</sub> concentrations and emissions (A 24-hour period per day divided by every 3 hours or every hour produced eight or twenty-four time intervals). A total of two blocks (two consecutive measuring days) was used for each measurement. Thus, the diurnal experiment was referred as a two-factorial design with 16 levels and 32 treatments for odour and H<sub>2</sub>S, as well as 48 levels and 96 treatments for NH<sub>3</sub> and CO<sub>2</sub>. The detailed layout of the 2×8 strip-block plot for odour and H<sub>2</sub>S is illustrated in Table 4.2.

Table 4.2 Detailed layout of the 2×8 strip-block plot design.\*

Day 1 (block 1)		Day 2 (block 2)	
Room 9	Room 10	Room 9	Room 10
1800 – 2100h	1800 – 2100h	1800 – 2100h	1800 – 2100h
2100 – 0000h	2100 – 0000h	2100 – 0000h	2100 – 0000h
0000 – 0300h	0000 – 0300h	0000 – 0300h	0000 – 0300h
0300 – 0600h	0300 – 0600h	0300 – 0600h	0300 – 0600h
0600 – 0900h	0600 – 0900h	0600 – 0900h	0600 – 0900h
0900 – 1200h	0900 – 1200h	0900 – 1200h	0900 – 1200h
1200 – 1500h	1200 – 1500h	1200 – 1500h	1200 – 1500h
1500 – 1800h	1500 – 1800h	1500 – 1800h	1500 – 1800h

\*This table is for odour and H<sub>2</sub>S experiment design. Room 9 has partially slatted floors and room 10 has fully slatted floors.

Statistic Analysis System (SAS) computer software (SAS Windows Version 8.02, Cary, NC) was employed to analyze the data to indicate the possibility of cause and effect relationships between variables (e.g. different flooring and diurnal effects) and odour and gas concentrations and emissions.

In the SAS program, a model for the strip-block analysis can be expressed as:

$$Y_{ijk} = u + \rho_i + (\alpha_j + \theta_{ij}) + (\beta_k + \gamma_{jk}) + (\alpha\beta)_{ik} + \varepsilon_{ijk} \quad (4.1)$$

where:  $Y_{ijk}$  is the odour and gas concentration or emission;  $u$  is the overall mean;  $\rho_i$  is the block effect;  $\alpha_j$  is the effect of factor A (*Flooring*);  $\theta_{ij}$  is the random effect of the whole-plot units involving factor A;  $\beta_k$  is the effect of factor B (*Diurnal*);  $\gamma_{jk}$  is the random effect of the whole-plot units involving factor B;  $(\alpha\beta)_{ik}$  is the interaction effect for factor A and B (*Flooring\*Diurnal*), and  $\varepsilon_{ijk}$  is the random effect of the sub-plot units. Table 4.3 gives the source of variation and degrees of freedom for the strip-block experiment.

Table 4.3 Source of variation and degrees of freedom for the strip-block experiment.

Source of Variation	Degrees of Freedom
Blocks (day)	1
Factor A (flooring)	1
Error (a)	1
Factor B (Diurnal)	7(23)
Error (b)	7(23)
A * B	7(23)
Residence Error	7(23)
Total	31(95)

Note: Numbers in parenthesis indicate NH<sub>3</sub> and CO<sub>2</sub> data analysis.

Duncan's Multiple Range test, Fisher-protected LSD test, PROC GLM and ANOVA (analysis of variance) table were used for data analysis. In the SAS output, the *P*-value was studied to examine the statistical significance of the effect of individual factors. If the value was less than  $\alpha=0.05$ , then  $H_0$  was rejected ( $H_0$ : null hypothesis, which means that there is no difference between two compared values), that is to indicate the means variance in one group was significant. If the value was greater than  $\alpha=0.05$ ,  $H_0$  was accepted, that is to indicate the means variance in one group was not significant. An ANOVA analysis was also completed to evaluate the individual factors and their effect on each other as well as to determine if there was an interaction between the two factors (the main-plot and sub-plot factors). If there was no interaction between the factors, then the factors acted independent of each other and it was appropriate to compare the averages for each level of a single factor. If the effect of one factor was different depending on the level of another factor, then the factors were not independent of each other. When factors interacted, comparison of the main effects was inappropriate and study of the responses of the factor within each level of the interacting factor needed to be investigated.

#### **4.2.2 Seasonal Measurement Experiment Design and Statistical Analysis**

The purpose of monitoring seasonal odour and gas concentration and emission in this study was to obtain seasonal odour and gas concentration and emission profiles. According to statistical principles, it was decided to use a repeated measurement method, which was suitable for the same experimental unit over a period of time. Thus, the seasonal experiment had been designed over a period of 12 months from August 2004 to July 2005 in four growing/finisher rooms. Grab samples of odour and gas were made

once each month during the monitoring period. For each measurement, one air sample was collected from each room. The sampling work was conducted at 1000h due to higher pig activities at that time that could result in higher odour and gas generation.

In statistical analysis, each sample month was treated as a repeat factor. The flooring system was a main factor having two levels, namely partially slatted flooring system and fully slatted flooring system. Each room with the same type of flooring system was considered as a block.

In the SAS program, the model of a split-block in time analysis was introduced. It was composed of two parts, a treatment part and a time part. The model can be expressed as:

$$Y_{ijk} = u + (\rho_i + \alpha_j + \varepsilon_{ij}) + \beta_k + (\alpha\beta)_{jk} + \varepsilon_{ijk} \quad (4.2)$$

where:  $Y_{ijk}$  is the odour and gas concentration or emission;  $u$  is the overall mean;  $\rho_i$  is the block effect;  $\alpha_j$  is the effect of main factor A (*'Flooring'*);  $\varepsilon_{ij}$  is the random effect of the whole-plot units involving main factor A;  $\beta_k$  is the effect of the repeated measure;  $(\alpha\beta)_{jk}$  is the interaction effect for factor A and measurement month, and  $\varepsilon_{ijk}$  is the random effect of the time portion. To apply the split-block model, it is assumed that there is equal variance for random effects among both subjects and across time intervals. Table 4.4 gives the source of variation and degrees of freedom for the repeated measurement experiment.

Table 4.4 Source of variation and degrees of freedom for the repeated measurement experiment.

Source of Variation	Degrees of Freedom
Block(room)	1
Flooring	1
Block*Flooring	1
Month	10
Block*Month	10
Flooring*Month	10
Error	10
Corrected Total	43

‘Proc MIX’ and ‘Proc GLM’ were used for developing analysis models to evaluate if the odour and gas concentrations and emissions differed significantly between the two flooring systems over a 12-month sampling period. The SAS output analysis process had two steps. The first step was to examine whether the interaction of ‘*Flooring*’ and ‘*Month*’ factors was significant or not. If the *P*-value of the interaction was greater than 0.05, which indicated the relative performance of flooring system did not differ over the sampling months, then the next step was to conduct the means comparison of the four rooms’ seasonal odour and gas concentrations and emissions in time analysis. If the *P*-value of the interaction was less than 0.05, which indicated the relative performance of flooring system differed significantly over the sampling months, then the next step was to analyze the effect of ‘*Flooring*’ factor on odour and gas concentrations and emissions under each month level.

### **4.2.3 Diurnal and Seasonal Odour and Gas Modelling Method**

Statistical models were developed for estimating odour and gas concentrations and emissions as a function of time of a day and season, ventilation rate, ambient and room temperatures and pig size and density, etc.

To develop the models, odour and gas concentrations and emissions were regarded as the output component. As for the model input portion, Berckmans et al. (1994) considered three principal energy inputs for air quality models: 1) the energy inputs from the animals; 2) the energy inputs from the inside and outside environment; 3) the energy inputs from the ventilation systems. Specifically, animal number and weight can reflect the energy inputs from the animals. Room and outdoor temperatures can reflect the energy inputs from the inside and outside environment and the animal body. Ventilation capacities can reflect the energy inputs from the ventilation systems. Thus, animal units (AU = 500 kg animal mass), room and outside temperatures, and ventilation rates were deemed as important factors for model input variables that affected the odour and gas concentration and emission. In this study, all diurnal and seasonal odour and gas concentrations and emissions data were pooled together for the model development.

Linear models were considered for the prediction models. In the SAS program for each odour or gas concentrations or emissions, several 'GLM' models were made and a best

prediction model was picked up according to their statistical analysis results. The detailed model development results are provided later in Section 5.3.

### **4.3 Odour and Gas Emissions Measurement Methods**

#### **4.3.1 A General View of Odour and Gas Measurement**

Odour and gas emission rate ( $E$ ) was determined by multiplying the total airflow rate of the ventilation fans by the increase in odour and gas concentrations between the room ventilation inlet and outlet:

$$E = V\Delta C \quad (4.3)$$

where:  $E$  is the total odour or gas emission rate from a room with unit of  $\text{OU s}^{-1}$  (odour unit per second),  $\text{g d}^{-1}$  (gram per day), or  $\text{kg d}^{-1}$  (kilogram per day).  $V$  is the room ventilation rate,  $\text{m}^3 \text{s}^{-1}$  and  $\Delta C$  is the difference in odour or gas concentrations between the room ventilation inlet and exhaust air, with unit of  $\text{OU m}^{-3}$  (odour unit per cubic metre), ppm, or  $\text{mg m}^{-3}$  (milligram per cubic metre). Odour and gas emission rates can be expressed on an animal unit basis or building floor area basis by dividing the total emissions by the total animal units in the room or total area of the room, i.e.  $\text{OU AU}^{-1} \text{s}^{-1}$  (odour unit per animal unit per second),  $\text{g AU}^{-1} \text{d}^{-1}$  (gram per animal unit per day), or  $\text{kg AU}^{-1} \text{d}^{-1}$  (kilogram per animal unit per day),  $\text{OU m}^{-2} \text{s}^{-1}$  (odour unit per square metre per second), or  $\text{g m}^{-2} \text{s}^{-1}$  (gram per square metre per second), or  $\text{kg m}^{-2} \text{s}^{-1}$  (kilogram per square metre per second).



Thus, in order to obtain odour,  $\text{NH}_3$ ,  $\text{H}_2\text{S}$  and  $\text{CO}_2$  emission rates, the measurement of odour and gas concentration differences between the outgoing and incoming air was essential. There were two measurement locations inside a room: one was at the inlet for incoming air concentrations, and the other was near the exhaust fans for outgoing air concentrations. It should be noted that incoming odour concentrations were ignored due to very low ambient odour concentrations. Hence, odour concentration was only measured near the exhaust fans.  $\text{H}_2\text{S}$  concentrations were also measured from the exhaust fans using the same air samples taken for odour concentration measurement because the outside  $\text{H}_2\text{S}$  concentration was very low and the  $\text{H}_2\text{S}$  meter could not be taken inside the barn due to the bio-security regulations of the barn. In this study, odour and gas concentration was the net concentration of odour and gas generated in the room.

In order to get the total ventilation rates, the speeds of all running fans including variable speed fans and the on/off single speed fans were monitored. The static pressure of the room was also measured.

Meanwhile, environmental parameters such as room and ambient temperature and relative humidity were also measured to obtain the barn and ambient climatic information. The room temperature and relative humidity sensors were located in the middle of the room 1.5 m above the floor. The ambient temperature sensor was located in the air inlet to measure the incoming air temperature. The locations of all sensors were the same for all experimental rooms, as shown in Figure 4.3.

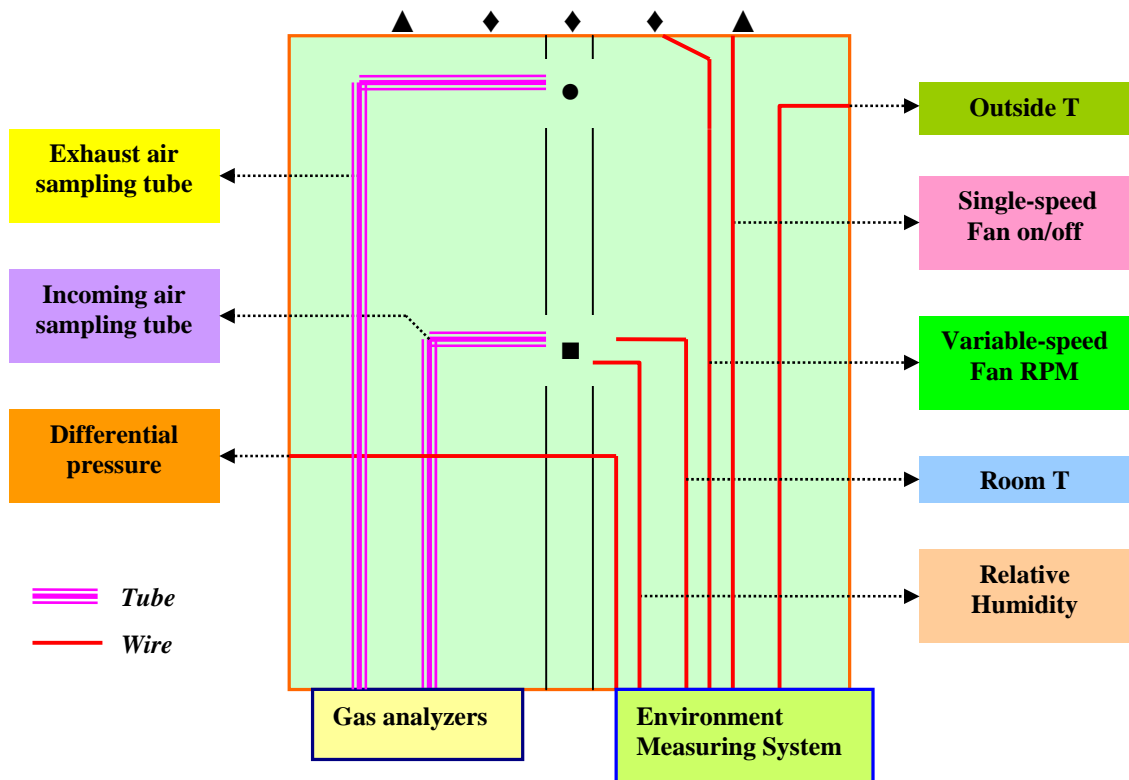

Figure 4.3 Measurement locations in an experimental room (variable-speed fan ◆; single-speed fan ▲; exhaust air sampling locations ●; inlet air sampling and room temperature, relative humidity location ■).

#### 4.3.2 Odour Concentration Measurement

As shown in Figure 4.3, odour samples were taken near the exhaust fans using 0.05 mm thick, 10-L Tedlar™ bags (Sample bags 232 series, SKC In., PA, USA). Before collecting a 6 to 7 L sample, the bag was flushed with 2 to 3 L of the sample air and emptied manually. For seasonal measurement, a commercial-made vacuum box was used to collect exhaust air in the sampling bags. An air pump was used to create a negative pressure in the vacuum box causing air to enter the sample bags without contamination from a mechanical pump. The amount of time to collect a sample (filling

a Tedlar™ bag) was about 2 to 5 minutes. Each sample, therefore, represents a 2 to 5 minute average odour concentration at the desired time. For diurnal measurement, two identical air samples were taken every three hours by continuously pumping exhaust air into the sample bags using a peristaltic pump (Masterflex L/S tubing pump plus Model-07017-52 pump head, Cole-Parmer Instrument Company, Illinois, USA). Therefore, it represented the average odour concentration of a 3-hour period.

Collected samples were transported overnight to the Olfactometry Laboratory at the University of Alberta for odour measurement within 30 hours. These odour samples were assessed by a dynamic-dilution, forced-choice olfactometer designed and built by the University of Alberta which meets the CEN (European standard) and ASTM olfactometry standards (ASTM, 1991). Eight screened odour panellists were used to determine the odour concentration that was expressed as the dilution-to-detection threshold (DT) or odour unit (OU). The detailed odour measurement method was discussed in Section 2.2.1.

#### **4.3.3 Gas Concentration Measurement**

Most ammonia, hydrogen sulfide and carbon dioxide concentration measuring devices provide direct reading on a volumetric basis. In this study, ammonia concentration was measured with an infrared NH<sub>3</sub> analyzer (Chillgard RT refrigerant monitor, MSA Instrument Division, USA). The Chillgard RT refrigerant monitor uses photo-acoustic infrared sensing technology to achieve an accurate one ppm (part-per-million) resolution

of refrigerant gases or ammonia. The analyzer has a set measuring range of 0 to 100 ppm with an accuracy of  $\pm 1$  ppm. Hydrogen sulfide concentration was measured using a Jerome™ meter (JEROME 631-X, Arizona Instrument Corporation, Phoenix, AZ, USA). It offers an analysis range of 0.003 - 50 ppm for odour and corrosion control, safety, and leak detection in facilities such as wastewater treatment plants and in oil and gas production. The accuracy of the meter is  $\pm 0.003$  ppm at 0.05 ppm,  $\pm 0.03$  ppm at 0.5 ppm and  $\pm 0.3$  ppm at 5 ppm. The Jerome 631-X utilizes a patented gold film sensor. The sensor's selectivity to hydrogen sulfide eliminates interference from sulphur dioxide, carbon dioxide, carbon monoxide, and water vapours. Carbon dioxide concentration was measured using an infrared carbon dioxide monitor (Guardian Plus Infra-Red Gas Monitor, Edinburgh Sensors Limited, Hingham, MA, USA) with  $\pm 2\%$  accuracy of the range (0 to 3000 ppm) and a hand held carbon dioxide air quality monitor (Edinburgh Sensors Limited, Hingham, MA, USA) with  $\pm 3\%$  accuracy of the range (0 to 5000 ppm). During each measurement, the gas concentrations were monitored three times. Then the average was obtained in order to decrease random error. In virtue of the characteristic of gas that varied very slowly within a period of time (ten minutes or so), the uncertainty of measurement was largely attributed to the accuracy of the meter used. So the error of gas data was tiny if the meter was properly calibrated and operated.

#### **4.3.4 Ventilation Rate Measurement**

There were five ventilation fans mounted on the back exterior wall for each experiment room. Three were variable-speed fans (TR24F, Prairie Pride Enterprises, Winnipeg, MB, Canada), which provided two ventilation stages (stages 1 and 2). The other two fans are

single-speed fans (TR36D01, Prairie Pride Enterprises, Winnipeg, MB, Canada), which formed the latter two ventilation rate stages (stages 3 and 4).

For the variable speed fans, there were three steps to determine the ventilation rate: (1) using a fan speed sensor installed on each fan shaft to measure fan RPM and a pressure transducer to measure the static pressure difference between the inside and outside of the swine barn. Also, the ON or OFF state of the single speed fans was monitored, (2) using fan testing report from the BESS lab, University of Illinois (Bio-environmental and Structural Systems Lab, 2001) as well as the measured fan RPM and pressure data to estimate the ventilation rate, and (3) modifying the ventilation rate using the field-based measurement results obtained by verifying the fans on site. The detailed fan model specifications and calibration results are given in Section 4.7.2.

The variable-speed fan RPM was measured using a microswitch Hall Effect position sensor (SR3F-A1, Honeywell Inc., Freeport, Illinois, USA). It has an integrated circuit chip that contains the Hall element and signal conditioning electronics. The SR3F Hall sensor senses the field produced by the magnetic system. The magnetic system responds to the physical quantity (position) to be sensed through the input interface. The output interface converts the electrical signal from the Hall sensor to a signal that meets the requirements of the RPM phase-locked loop circuit (Figure 4.4).

As Figure 4.4 shows, the output signal from the Hall sensor was a frequency signal. This signal was fed to a phase-locked loop circuit in order to lock this signal, multiply it by

100, synchronize a sweep or system timing to it, remove noise from it, and band pass-filter it. In the circuit, a locally generated signal from a voltage-controlled oscillator (VCO) was provided. The output of the VCO was then routed to a divide-by-n counter. The output of the divide-by-n counter was compared to the input fan frequency in a phase detector. The output of the phase detector was a voltage that represented the error between the input-signal phase and the phase of the divided-down VCO signal. In turn, this error signal was filtered and used to control the frequency of the voltage-controlled oscillator. The final filter-to-VCO connection closed the loop, forcing the VCO to track and follow the input fan frequency so that the output signal was proportional to the fan RPM. Finally, an F-V circuit was designed to convert the output frequency to voltage signal.

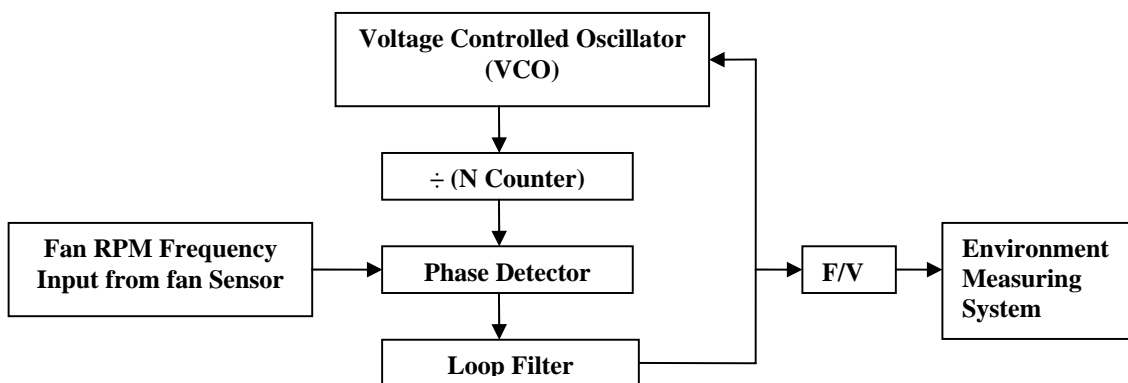

Figure 4.4 Schematic RPM phase-locked loop circuit.

A differential pressure transducer (Model 264, Setra System Inc, Boxborough, MA, USA) with an accuracy of  $\pm 1\%$  full scale (0 -  $\pm 0.5$  in. W. C.) was utilized to measure the static pressure difference between the outside and inside of the barn. It has two tubes, one connected to the outside, and the other connected to the middle of the swine room. The Setra pressure transducer can convert the sensed pressure difference to a

proportional high level analog output for both unidirectional and bidirectional pressure ranges.

#### **4.4 Environmental Parameters Measurement**

The environmental parameters such as temperature and relative humidity inside and outside the barn were measured using temperature sensors (TC 1047, Microchip Technology Inc., Chandler, AZ, USA) and a relative humidity sensor (HIH-3160, Honeywell Inc., Freeport, Illinois, USA). The temperature sensor was a linear voltage output sensor that can accurately measure temperature from  $-40^{\circ}\text{C}$  to  $125^{\circ}\text{C}$  with  $\pm 0.5^{\circ}\text{C}$  precision. The relative humidity sensor was a laser trimmed thermo set polymer capacitive sensing element with on-chip integrated signal conditioning. The accuracy of the RH sensor was  $\pm 2\%$  ( $25^{\circ}\text{C}$ ,  $V = 5\text{ VDC}$ ). The RH (relatively humidity) sensors were covered with PVC covers to filter dust and light out to protect the sensors.

#### **4.5 Embedded Microcomputer-based Environment Measuring System Design**

An embedded microprocessor-based environment measuring system was designed and built for this study (Appendix A). All the environmental parameter monitoring signals from the temperature sensors, relative humidity sensors, fan on/off event devices, pressure transducers, and their peripheral measuring circuits were connected to the embedded microprocessor-based environment measuring system.

The environment measuring system had three parts as showed in Figure 4.5. The first part (embedded system) was an embedded micro-computer system (TFX-11v2, Onset Corporation, USA), which included dual-microcomputers, ADC inverters, flash data EEPROM, RAM, and input/output interface, etc. The second part (signal monitoring and processing) was to use temperature and relative humidity sensors, pressure transducers, variable-speed fan sensors and signal-speed fan detectors to measure environment information, as well as design signal processing circuits to convert the electrical signal from those sensors to the signals that met the requirements (0-5 V or 4-20 mA) of the microcomputer system. The third part (communication) was a communication network to send data (various sensor inputs) to a laptop computer. All the measuring data could be monitored and downloaded from the laptop. Figure 4.6 shows the picture of part of environment measuring system.

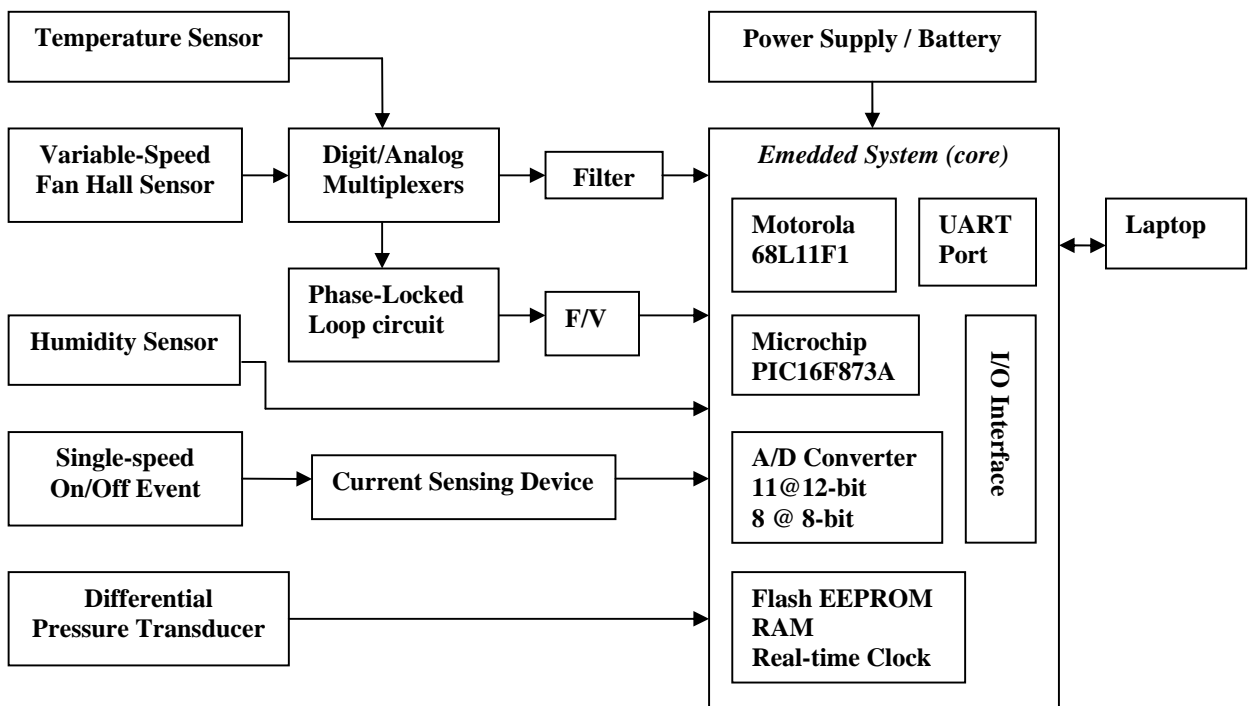

Figure 4.5 Embedded microprocessor-based environment measuring system.



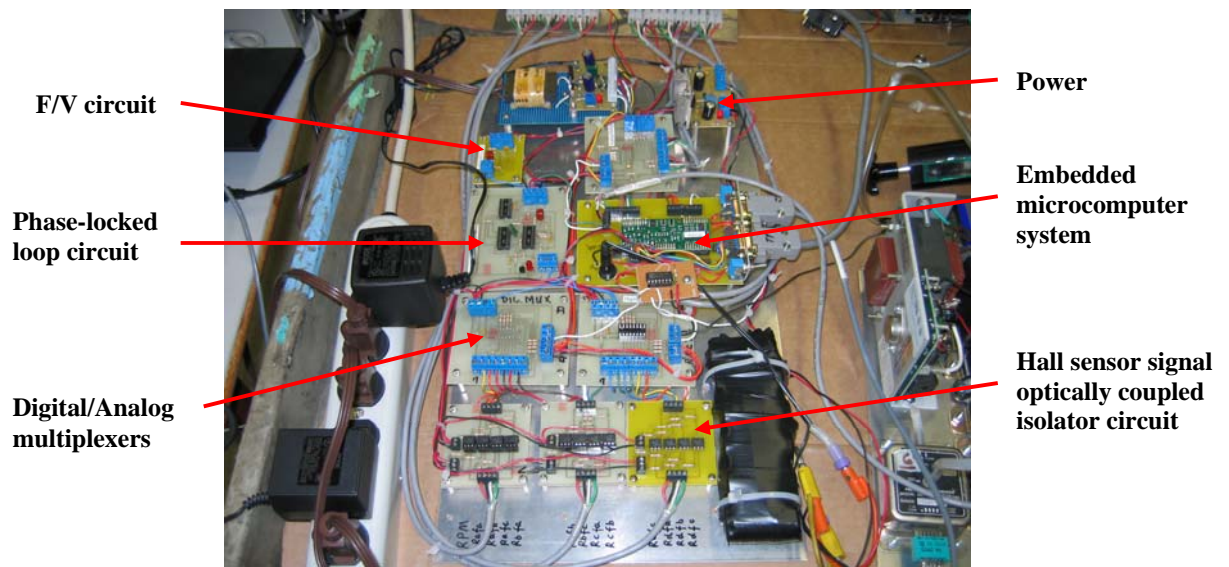

Figure 4.6 Picture of part of environment measuring system.

#### 4.6 Animal Management Information

At the end of each measurement, pig weight was measured using the weighing station installed in the grower/finisher wing. A male pen and a female pen were chosen from each test room. The total weight of the pigs in those two pens was measured and the average pig weight was estimated. The pig numbers for each room were also recorded. Thus, the total of pig weight in each room was calculated by the average pig weight multiplied by the pig numbers, as well as the total animal unit in the room was obtained by dividing the total animal weight by 500 kg animal mass.

According to the pig production management, the grower/finisher wing has 14 rooms allowing for 1 room to be emptied, cleaned and re-filled each week. This allows for a 14 week room rotation. Therefore, after every 14 weeks production cycle, the temperature,

relative humidity sensors and electrical connection boxes were sealed with duct tape to avoid any potential damage when the room was cleaned by the power-washing.

## **4.7 Calibration of the Sensors and Verification of the Fan Airflow Rate**

### **4.7.1 Calibration of the Sensors**

All the temperature sensors, relative humidity sensors, pressure transducers and fan sensors were calibrated in the lab before being installed in the pig barn. The angelantoni climatic systems (Massa Martana, Italy), Hydro-MZ dew point monitor (General Ester Co, USA), pressure meter (HHP-103, OMEGA, England), 50 MHZ pulse generator (Model 801, Wavetek, CA, USA) and 1.3 GHZ frequency counter (FC130A, Beckman Industrial Co., CA, USA) were used to calibrate temperature sensors, relative humidity sensors, pressure transducers and Hall fan sensors respectively. The calibration results are presented in Appendix B.

### **4.7.2 Verification of the Fan Air flow Rate**

In this study, the fan curve method was employed to verify ventilation rates. The fan speed and differential static pressure between inside and outside the barn can be measured automatically by the embedded microcomputer-based environment measuring system. Then the real-time dynamic measurements of fan ventilation can be obtained from the readings of fan speed and static pressure according to the lab test sheet.

However, the fans have been operating in the barn since March 29, 2001 and could have been affected by the barn environment. The field performance of the fans was likely different from the lab testing results. Hence, the airflow rates obtained from the fan curve method need to be corrected in order to obtain the real airflow rates. Fan verification could provide field-based measurements for modifying the results obtained by the fan curve method.

As shown in Figure 4.7, the single speed exhaust fan (Model: TR36D01) was made by Prairie Pride Polyfan Enterprise, Winnipeg, MB, Canada. The fan size was 91.4 cm (36'') diameter. It had a short straight duct having the same diameter as the fan and top of length 33 cm and bottom of length 23 cm. There was a guard installed in the duct. The measurement plane was about 5 cm inside the bottom edge of the duct. The variable speed fan was a model TR24F, 63.5 cm (25'') diameter. The measurement plane location was the same as for the TR36D01 fan.



Figure 4.7 Model TR36D01 exhaust fan.

Fan airflow rates were verified using an anemometer with an accuracy of  $\pm 1.5\%$  at  $10.16 \text{ m s}^{-1}$  (Model 8385, Velocicalc Plus air velocity meter, TSI Inc., MN, USA). A total of 24 points needed to be measured at the traverse fan plane based on the ASHRAE Standards (AMCA Standards Handbook 51). Figure 4.8 showed the measurement points in the cross section of the exhaust duct.

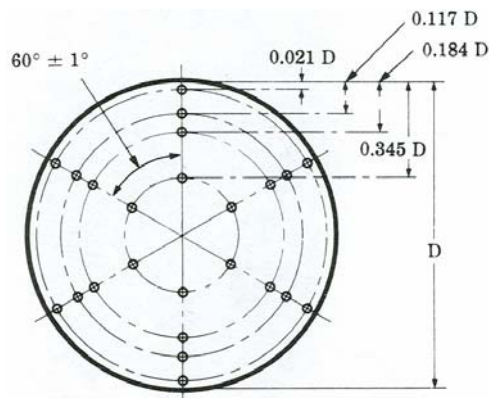

Figure 4.8 Measurement points in the plane.

The average of the four measurements in the traverse plane at  $60^\circ$  angles was measured to an accuracy of  $0.2\% D$  ( $D$ : diameter of the duct). Before starting calibration, the measurement points were marked at the guard according to Figure 4.8. Under each of the various static pressure control setups, the anemometer was used to measure the air exit speed at 24 points. Each point was measured three times. The fan ventilation rates were the product of the fan traverse plane area and the average air speed at that area. A total of three variable-speed fans (fan a, fan b, and fan c) and two single-speed fans (fan 1 and fan 2) were tested in the field. It was found that the field fan performance was 4% and 6% lower than the fan lab testing data for the variable-speed fan and the single-speed fan, respectively.

## **5. RESULTS AND DISCUSSION**

### **5.1 Diurnal Odour and Gas Concentration and Emission Profiles**

The purpose of diurnal odour and gas emissions monitoring was to obtain diurnal odour and gas emission profiles during different seasons. The measurements were conducted three times in swine rooms 9 and 10 in a year, once a month in August, October, and February. These three months represented three typical weather conditions (warm weather, mild weather and cold weather, respectively). During each measurement, odour and H<sub>2</sub>S samples were taken every three hours, NH<sub>3</sub> and CO<sub>2</sub> every hour for two consecutive days (48 hours). A two-factorial strip-block experiment design was used for investigating the influence of different flooring systems, air temperature, ventilation rate, pig size and density, and swine management, etc. on the diurnal variations of odour and gas concentrations and emissions from different swine rooms during different measurement periods.

#### **5.1.1 Diurnal Odour and Gas Concentration and Emission Profiles in August**

##### **5.1.1.1 Odour Concentration and Emission**

The diurnal variation trend of ambient and room temperature, ventilation rate, odour concentrations and emissions in rooms 9 and 10 in August, 2004, are illustrated in Figure 5.1.

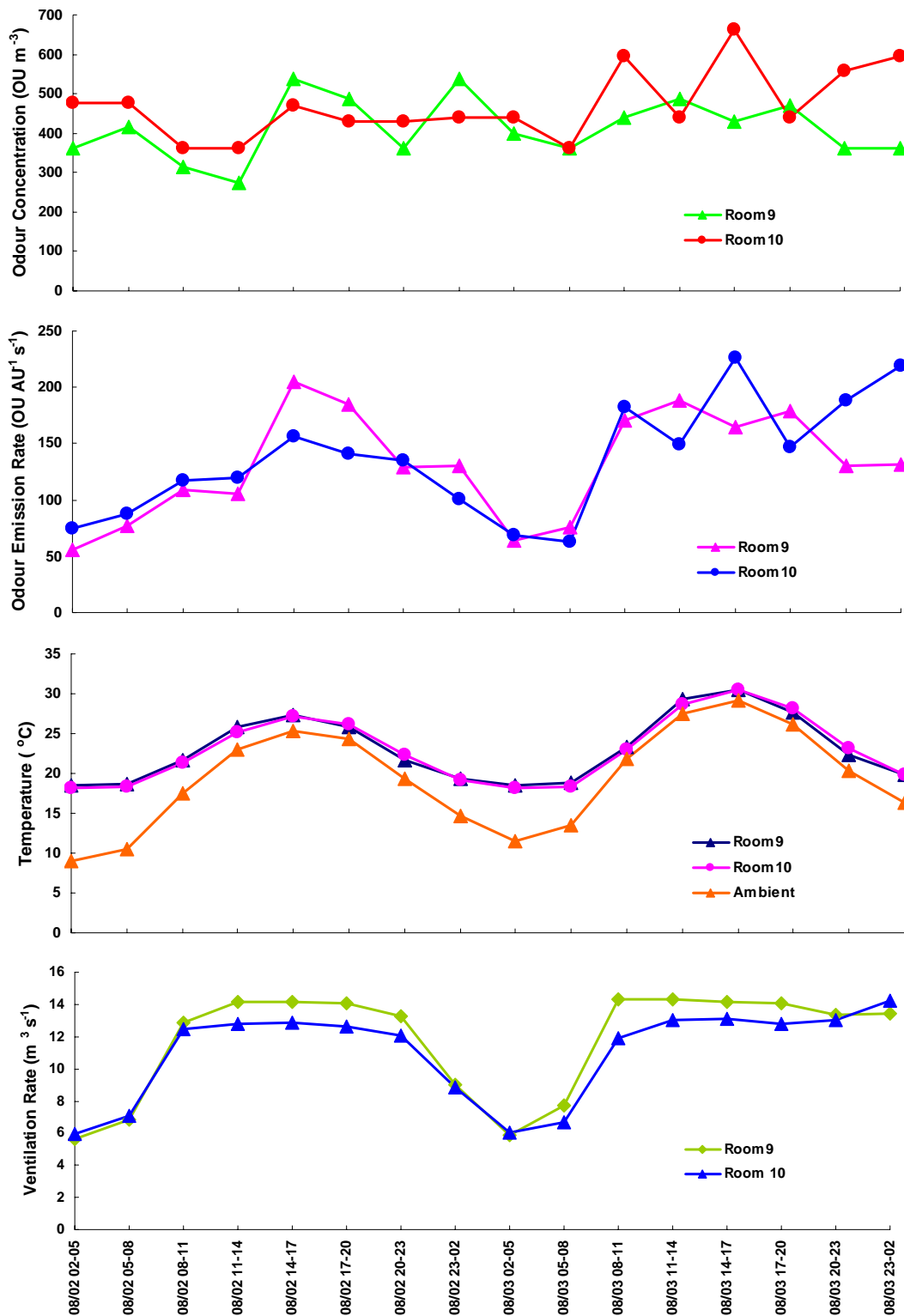

Figure 5.1 Odour concentrations, emissions, room and ambient temperatures, and ventilation rates for August 2 to 4, 2004.

As the graphs show, the diurnal patterns of room temperature and ventilation rate were much similar to those of ambient temperature since the daily mean room temperature was closely related to the ambient temperature during warm weather. When the diurnal variation of the outdoor temperature caused a corresponding variation of the room temperature, the ventilation rate was automatically controlled in order to maintain optimum room temperature; hence the ventilation rate was positively correlated with the room temperature. It can be further seen that the ventilation rate reached its maximum capacity and kept relatively constant from 0800 h to 2300 h due to the high ambient temperature, as well as odour concentrations were somewhat inversely related to the ventilation rate and ambient temperature; however, this inverse relationship was not pronounced. Two peaks of odour concentrations were observed during the daytime for both rooms when the ventilation rates were not changed: the first was 538 OU m<sup>-3</sup> in room 9 from 1400 to 1700 h for measurement day 1 and the second was 664 OU m<sup>-3</sup> in room 10 also from 1400 to 1700 h for measurement day 2. One possible explanation could be due to the management of the swine rooms in which the workers scraped the manure off the flooring to the pits from 1500 to 1530 h, resulting in more odour and gas release and an increase in pig activity. Another possible explanation could be attributed to the effects of the high ambient and room temperature that might be favourable for more odour and gas generating from manure. Another peak in odour concentration occurred in room 9 during 2300 to 0200 h interval, which was probably due to pig activity as the ventilation rate did not decrease, but this assumption could not be confirmed.

It can be visually seen that the odour emission rate curve nicely followed the ventilation rate curve. When the ventilation rate increased, the emission rate also increased and vice versa since the emission rate is the product of the odour concentration and the ventilation rate. While the ventilation rate stayed at relatively constant level during the daytime, the variation of odour emission rate largely depended on the variation of the odour concentration.

### 5.1.1.2 Odour Concentration and Emission Statistical Analysis

The three-hour means, standard deviations (S.D.) and range of measured odour concentrations and emissions, room and ambient temperature, ventilation rates and pigs' weight are summarized for each room in Table 5.1.

Table 5.1 Three-hour means, S.D. and ranges of measured variables in August.

Variables	Room 9*			Room 10*		
	Mean (S.D.)	Min	Max	Mean (S.D.)	Min	Max
Odour concentration (OU m <sup>-3</sup> )	406 (77)	275	538	464 (87)	362	664
Odour emission rate (OU AU <sup>-1</sup> S <sup>-1</sup> )	122.2 (47.7)	55.4	205.4	126.7 (50.8)	62.8	226.5
Odour emission rate (OU m <sup>2</sup> s <sup>-1</sup> )	18.1 (7.1)	8.2	30.4	19.5 (7.8)	9.7	34.9
Ventilation rate (m <sup>3</sup> s <sup>-1</sup> )	11.70 (3.36)	5.66	14.31	10.96 (2.93)	5.98	14.22
Room temperature (°C)	23.1 (4.1)	18.5	30.5	23.0 (4.2)	18.2	30.5
Outside temperature (°C)	19.4 (6.4)	9.0	29.2	19.4 (6.4)	9.0	29.2
Pig inventory		261			246	
Average pig mass (kg)		70.9			78.3	
Total pig mass (kg)		18500			19300	

\*Room 9: partially slatted flooring system; Room 10: fully slatted flooring system.

Number of odour sample: 16 for each room.

Tables D.1 and D.2 in Appendix D give the statistical analysis results from the SAS output for odour concentration and emissions. It was found that: (1) odour concentrations did not differ significantly between rooms 9 and 10. Thus, it can be



concluded that different flooring systems in rooms 9 and 10 had no significant effect on the odour concentrations during warm weather; (2) no significant diurnal variations of odour concentrations were observed in rooms 9 and 10; (3) there was no interaction between the '*Flooring*' factor and the '*Diurnal*' factor for the odour concentration; (4) rooms 9 and 10 were treated as the same type of swine room to calculate odour emissions as the '*Flooring*' factor had no significant effect on either of them; (5) the '*Diurnal*' factor was statistically significant on the odour emissions. Since there was no significant difference in odour concentrations between rooms 9 and 10, the variation of odour emissions was mainly attributed to the ventilation rate. This large variation in odour emissions could be best explained by the large variation in ventilation rate due to large diurnal variations of ambient and room temperature, and (6) no interaction term found within '*Flooring*' and '*Diurnal*' factors made possible to combine odour emission data from different rooms and compare their means together. Thus, during warm weather, the odour emissions had a geometric mean of  $124.4 \text{ OU AU}^{-1} \text{ s}^{-1}$  ( $18.8 \text{ OU m}^{-2} \text{ s}^{-1}$ ) with a diurnal variation from  $55.4 \text{ OU AU}^{-1} \text{ s}^{-1}$  ( $8.2 \text{ OU m}^{-2} \text{ s}^{-1}$ ) to  $226.5 \text{ OU AU}^{-1} \text{ s}^{-1}$  ( $34.9 \text{ OU m}^{-2} \text{ s}^{-1}$ ).

#### **5.1.1.3 Gas Concentration and Emission and Statistical Analysis**

The diurnal variations of  $\text{NH}_3$  concentration and emission measurements taken from rooms 9 and 10 are shown in Figure 5.2 with the error bars. It is noted that the error bars are not included in the other figures in order to make readers see the curves clearly. Moreover, the scales of the figures for the three diurnal odour and gas measurements are different in order to reflect the diurnal variations of the measured parameters during three different seasons.

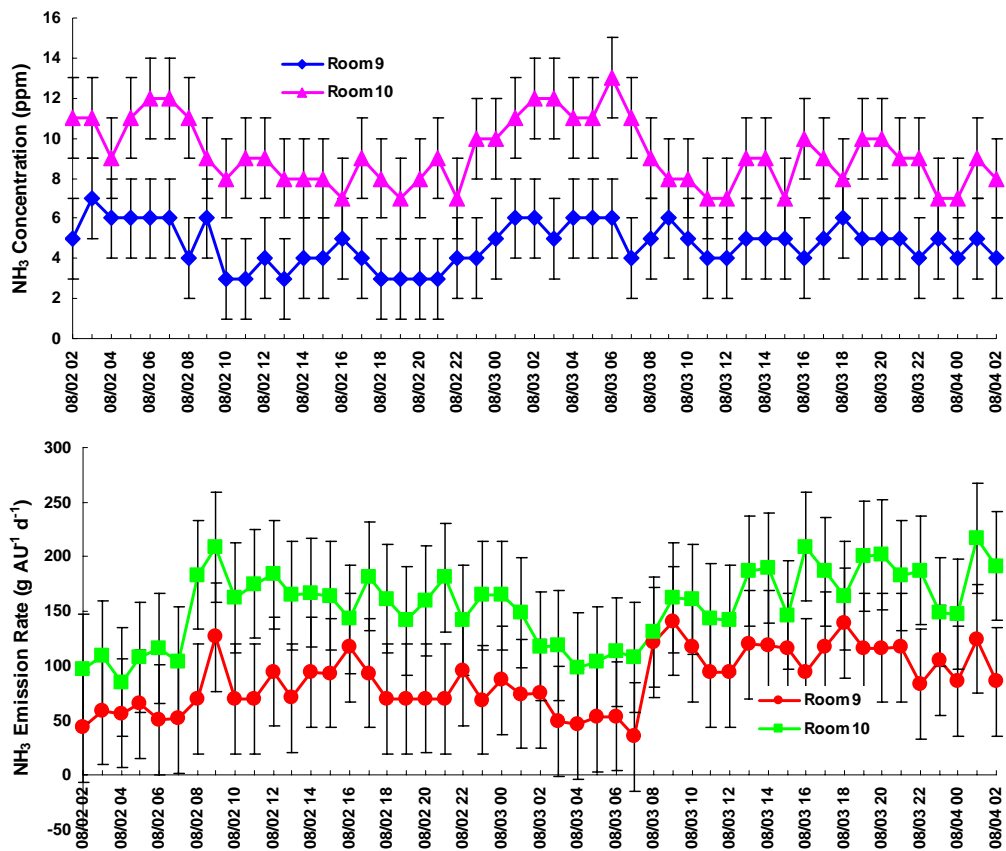

Figure 5.2 NH<sub>3</sub> concentrations and emissions for August 2 to 4, 2004.

The diurnal NH<sub>3</sub> concentration variations can be seen during warm weather with NH<sub>3</sub> levels approaching 7 ppm (room 9) and 13 ppm (room 10) during night time and dropping down to 3 ppm (room 9) and 7 ppm (room 10) during the day due to the large fluctuations of ventilation rates and ambient temperature. As Figure 5.2 shows, the diurnal patterns in the NH<sub>3</sub> emissions showed less variation than the concentrations, since the NH<sub>3</sub> emission rate is usually calculated by multiplying building airflow rate by the concentrations of exhaust NH<sub>3</sub>.

The diurnal variations of H<sub>2</sub>S concentration and emission measurements made in rooms 9 and 10 are shown in Figure 5.3. There were less diurnal variations in H<sub>2</sub>S

concentrations for both rooms as compared to the NH<sub>3</sub> concentrations. The H<sub>2</sub>S concentrations were consistently within the range of 0.019 – 0.024 ppm during the majority of measurement period but a sharp peak occurred in room 10 between 0500 and 0800 h for the first sampling day. The explanation for this peak was probably due to the relatively low ventilation rate in the early morning combined with the increase of pig activity.

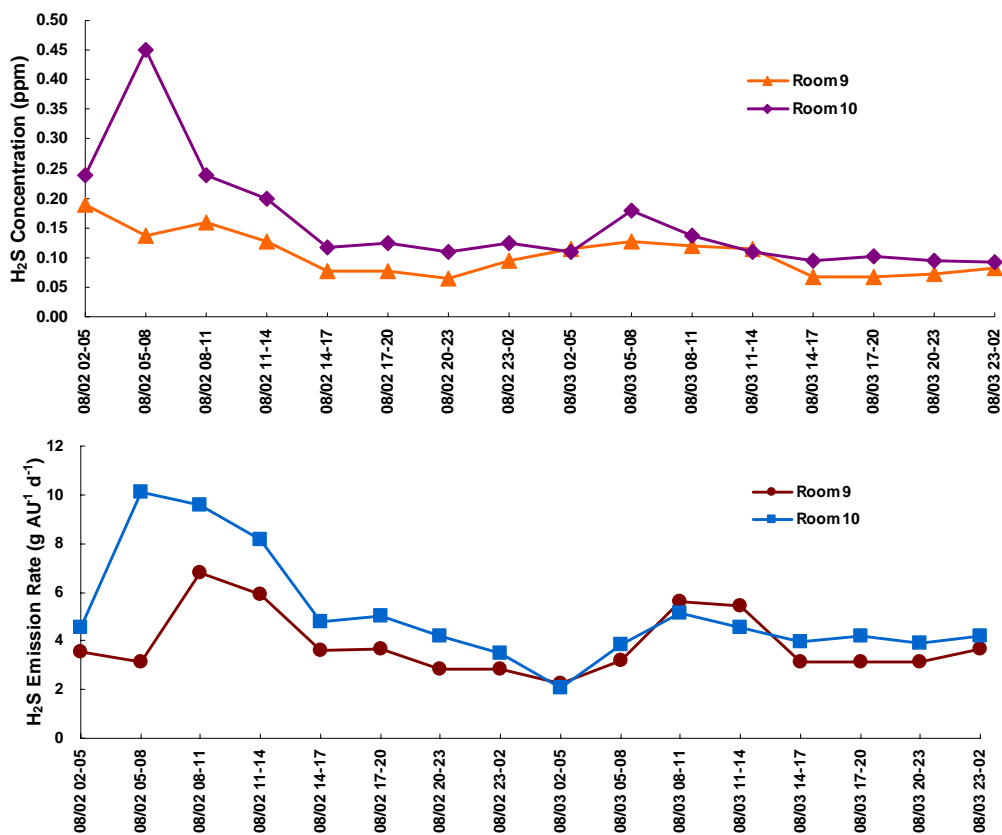

Figure 5.3 H<sub>2</sub>S concentrations and emissions for August 2 to 4, 2004.

The diurnal patterns of H<sub>2</sub>S emissions in rooms 9 and 10 were more apparent than the patterns of the concentrations. The reason may be attributed to the large variation of the ventilation rate during the daytime and night time.

The diurnal variations of CO<sub>2</sub> concentrations and emissions released from rooms 9 and 10 are shown in Figure 5.4. The variation pattern of CO<sub>2</sub> concentrations in room 9 was very similar to the concentrations pattern of the room 10, with relatively high concentrations (greater than 700 ppm) during the night and low concentrations (less than 430 ppm) during the day time. This diurnal trend was probably explained by the CO<sub>2</sub> concentrations varying inversely with the ventilation rate and ambient temperature.

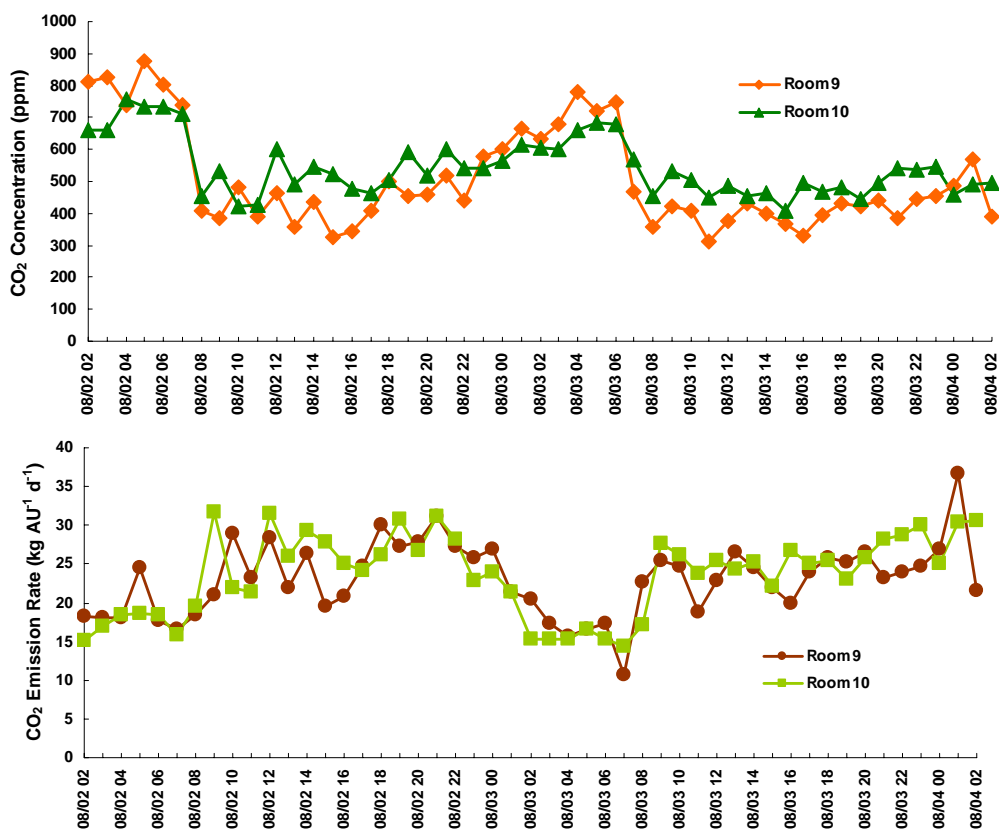

Figure 5.4 CO<sub>2</sub> concentrations and emissions for August 2 to 4, 2004.

The diurnal patterns of CO<sub>2</sub> emissions for both rooms were almost the same due to the similar variations of ventilation rates and CO<sub>2</sub> concentrations between those two rooms.

The hourly means, standard deviations (S.D.), and ranges of gas concentrations and emissions, ventilation rate, room and ambient temperature in August are listed for each room in Table 5.2.

Table 5.2 Hourly means, S.D. and ranges of measured variables in August.\*

Variables	Room 9			Room 10		
	Mean (S.D.)	Min	Max	Mean (S.D.)	Min	Max
NH <sub>3</sub> concentration (ppm)	5.0 (1.0)	3.0	7.0	9.0 (2.0)	7.0	13.0
NH <sub>3</sub> emission rate (g AU <sup>-1</sup> d <sup>-1</sup> )	86.9 (27.5)	35.3	141.0	154.7 (33.9)	85.3	217.1
NH <sub>3</sub> emission rate (g m <sup>-2</sup> d <sup>-1</sup> )	12.9 (4.1)	5.2	20.9	23.8 (5.2)	13.1	33.4
H <sub>2</sub> S concentration (ppm)	0.106 (0.037)	0.064	0.190	0.158 (0.092)	0.093	0.450
H <sub>2</sub> S emission Rate (g AU <sup>-1</sup> d <sup>-1</sup> )	3.9 (1.3)	2.2	6.8	5.1 (2.2)	2.1	10.1
H <sub>2</sub> S emission rate (g m <sup>-2</sup> d <sup>-1</sup> )	0.6 (0.2)	0.3	1.0	0.8 (0.3)	0.3	1.6
CO <sub>2</sub> concentration (ppm)	508 (156)	310	875	544 (90)	410	755
CO <sub>2</sub> emission Rate (kg AU <sup>-1</sup> d <sup>-1</sup> )	23.0 (4.7)	10.7	36.7	23.6 (5.2)	14.4	31.7
CO <sub>2</sub> emission rate (kg m <sup>-2</sup> d <sup>-1</sup> )	3.4 (0.7)	1.6	5.4	3.6 (0.8)	2.2	4.9
Ventilation rate (m <sup>3</sup> s <sup>-1</sup> )	11.7 (3.4)	5.7	14.3	11.0 (2.9)	6.0	14.2
Room temperature (°C)	23.1 (4.1)	18.5	30.5	22.9 (4.2)	18.2	30.5
Outside temperature (°C)	19.4 (6.4)	9.0	29.2	19.4 (6.4)	9.0	29.2

\*Room 9: partially slatted flooring system; Room 10: fully slatted flooring system. g AU<sup>-1</sup> d<sup>-1</sup>: gram per animal unit per day; g m<sup>-2</sup> d<sup>-1</sup>: gram per square metre per day; kg AU<sup>-1</sup> d<sup>-1</sup>: kilogram per animal unit per day; kg m<sup>-2</sup> d<sup>-1</sup>: kilogram per square metre per day; Number of NH<sub>3</sub>, H<sub>2</sub>S and CO<sub>2</sub> samples: 48, 16, 48 for each room, respectively.

Tables D.3 to D.5 in Appendix D provide the statistical results from the SAS output for NH<sub>3</sub>, H<sub>2</sub>S and CO<sub>2</sub> concentration, respectively. It was found that there was no significant difference for the H<sub>2</sub>S and CO<sub>2</sub> concentrations between rooms 9 and 10, but the NH<sub>3</sub> concentration differed significantly between rooms 9 and 10, as well as the ‘*Diurnal*’ effect (a function of ambient and room temperature, ventilation rate, the swine management, etc.) had a significant effect on diurnal gas concentration.

Tables D.6 to D.8 in Appendix D give the statistical results from the SAS output for NH<sub>3</sub>, H<sub>2</sub>S and CO<sub>2</sub> emission, respectively. It was observed that there was no significant

difference for the NH<sub>3</sub>, H<sub>2</sub>S and CO<sub>2</sub> emissions between rooms 9 and 10; the '*Diurnal*' effect (a function of ambient and room temperature, ventilation rate, the swine management, etc) had a significant effect on NH<sub>3</sub> and CO<sub>2</sub> emissions, but no significant effect on H<sub>2</sub>S emissions in August.

### **5.1.2 Diurnal Odour and Gas Concentration and Emission Profiles in October**

The October odour and gas measurements had to be cancelled after the first sampling day due to the severe weather and road conditions and were resumed after a week.

#### **5.1.2.1 Odour Concentration and Emission**

The diurnal variation trend of ambient and room temperature, ventilation rate, odour concentrations and emissions in rooms 9 and 10 in October, 2004, are illustrated in Figure 5.5.

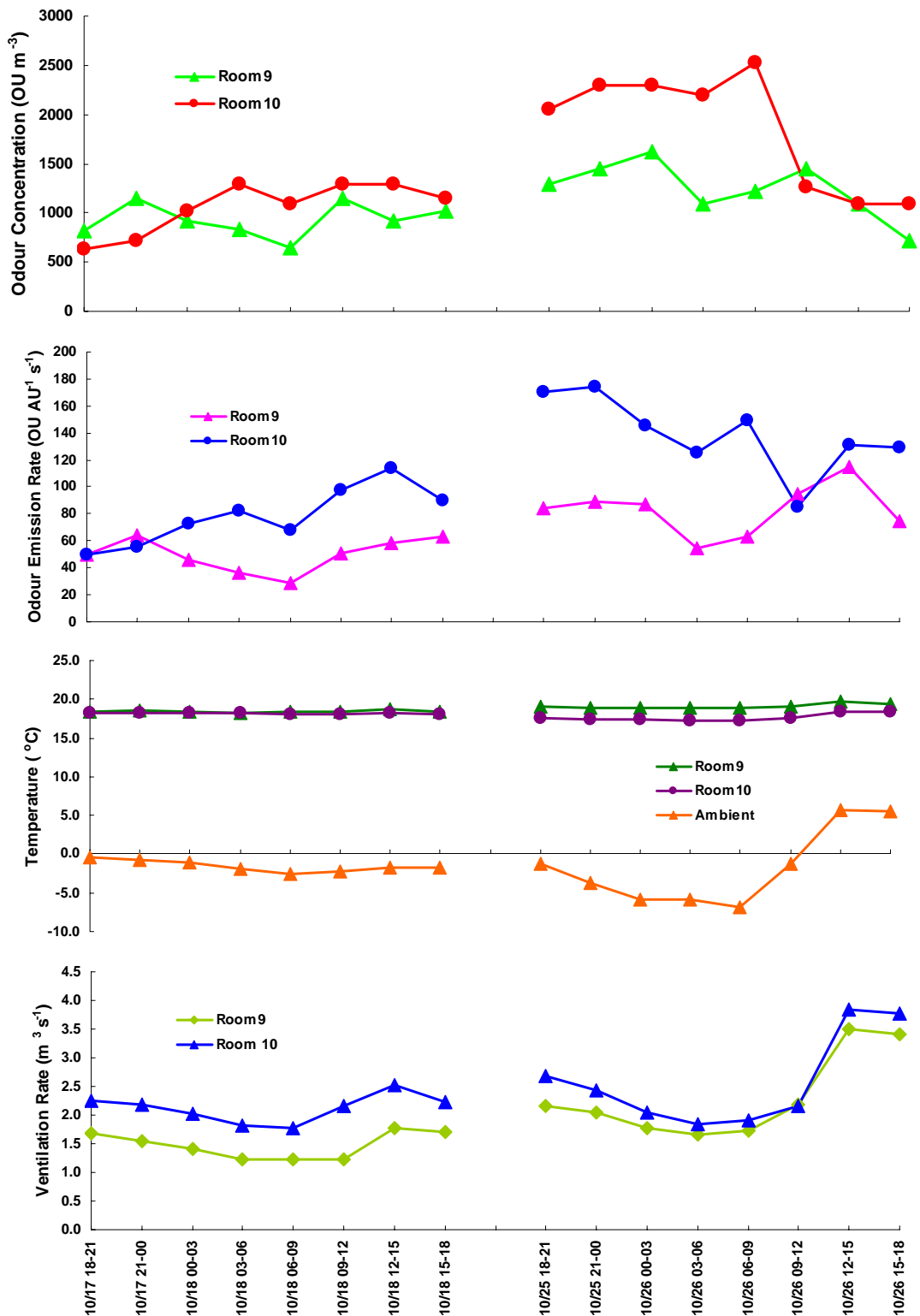

Figure 5.5 Odour concentrations, emissions, room and ambient temperature and ventilation rates for October 17 to 18 and 25 to 26, 2004.

As shown in Figure 5.5, the trend of ventilation rate curve can be matched with the trend of the ambient temperature ( $r^2 = 0.74$ ), but the room temperature was kept fairly constant, suggesting that the ventilation rate was well controlled to maintain the room temperature setpoint with a cooler fall ambient temperature than summer. It can be further observed that the odour concentrations were still inversely related to the ventilation rate and ambient temperature for most of the measurement time. In room 10 from 0600 to 0900 h for the second sampling day, the odour concentration approached the maximum level because the ambient temperature and ventilation rate dropped down to the minimum. It is interesting to note that room 9 odour concentrations were characterized by a positive relationship with the ventilation rate and ambient temperature that occurred during 0000-0900 h interval on October 18 and during 0000-1200 h interval on October 26. Conversely, room 10 odour concentrations were strictly inversely correlated with the ventilation rate. It is difficult to explain the difference of this situation under the same weather conditions. Figure 5.5 also shows the diurnal pattern of odour emissions, which was similar to the pattern of the ventilation rate.

#### **5.1.2.2 Odour Concentration and Emission Statistical Analysis**

The three-hour means, standard deviations (S.D.), and ranges of odour concentrations and emissions, room and outside temperature, ventilation rates and pigs weight are summarized for each room in Table 5.3.



Table 5.3 Three-hour means, S.D. and ranges of measured variables in October.

Variables	Room 9*			Room 10*		
	Mean (S.D.)	Min	Max	Mean (SD)	Min	Max
Odour concentration (OU m <sup>-3</sup> )	1053 (77)	645	1625	1345 (603)	630	2521
Odour emission rate (OU AU <sup>-1</sup> S <sup>-1</sup> )	62.2 (23.1)	28.6	115.2	101.7 (39.5)	49.6	174.4
Odour emission rate (OU m <sup>-2</sup> s <sup>-1</sup> )	7.6 (3.5)	3.2	15.3	12.3 (5.5)	5.7	22.4
Ventilation rate (m <sup>3</sup> s <sup>-1</sup> )	1.89 (0.70)	1.22	3.50	2.35 (0.60)	1.77	3.84
Room temperature (°C)	18.8 (0.4)	18.3	19.7	17.9 (0.4)	17.2	18.4
Outside temperature (°C)	-1.6 (3.4)	-6.8	5.7	-1.6 (3.4)	-6.8	5.7
Pig inventory	257; 270*			240; 240*		
Average pig mass (kg)	53.9; 61.7*			59.5; 67*		
Total pig mass (kg)	13800; 16700*			14300; 16100*		

\*Two measurements in October 18 and 26, respectively; Room 9: partially slatted flooring system; Room 10: fully slatted flooring system. Number of odour samples: 16 for each room.

Tables D.9 and D.10 in Appendix D provide the statistical results from the SAS output for odour concentration and emission in October, respectively. It was found that: (1) odour concentrations did not differ significantly between rooms 9 and 10. Thus, it can be concluded that the different flooring systems in rooms 9 and 10 had no significant effect on the odour concentrations; (2) no significant diurnal variation of odour concentrations was observed in rooms 9 and 10 in October; (3) there was no interaction between the ‘*Flooring*’ factor and the ‘*Diurnal*’ factor for the odour concentration; (4) rooms 9 and 10 could be considered as the same type of swine room for calculating odour emissions since the ‘*Flooring*’ factor had no significant effect on either of them; (5) the insignificant effect of ‘*Diurnal*’ factor on the odour emissions implies that they were not significantly different during a 24-hour period in October. It could be explained by the inverse relationship between the ventilation rate and the odour concentrations, which made the odour emissions vary within a small range, and (6) no interaction was found within ‘*Flooring*’ and ‘*Diurnal*’ factors so it was possible to combine the data of odour emissions from different rooms and compare their means

together. Thus, the odour emission rates had a geometric mean of  $79.5 \text{ OU AU}^{-1} \text{ s}^{-1}$  ( $9.7 \text{ OU m}^{-2} \text{ s}^{-1}$ ) with a diurnal variation from  $28.6 \text{ OU AU}^{-1} \text{ s}^{-1}$  ( $3.2 \text{ OU m}^{-2} \text{ s}^{-1}$ ) to  $174.4 \text{ OU AU}^{-1} \text{ s}^{-1}$  ( $22.4 \text{ OU m}^{-2} \text{ s}^{-1}$ ).

### 5.1.2.3 Gas Concentration and Emission and Statistical Analysis

The diurnal variations of  $\text{NH}_3$  concentration and emission measurements taken from rooms 9 and 10 are shown in Figure 5.6.

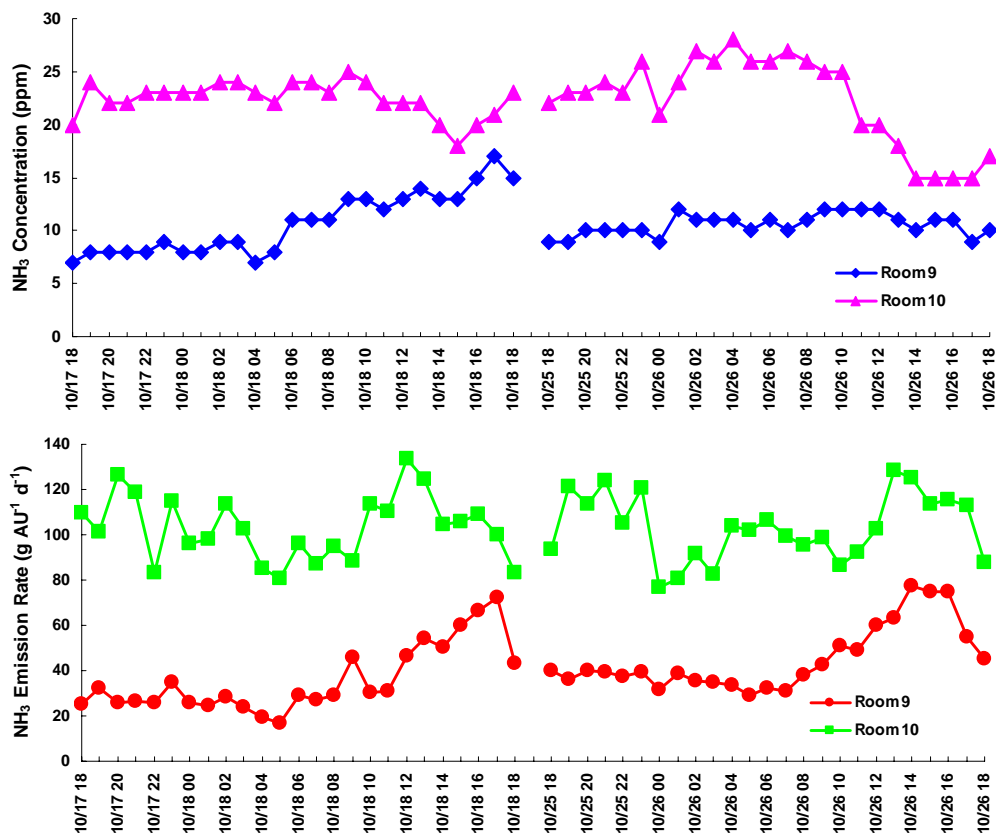

Figure 5.6  $\text{NH}_3$  concentrations and emissions for October 17 to 18 and 25 to 26, 2004.

As the graphs show, the diurnal hourly  $\text{NH}_3$  concentration in room 10 varied inversely with the ventilation rate. This trend was more pronounced in the second measurement day than the first day due to the relatively larger fluctuations of the ventilation rate and ambient temperature in day two. Conversely, the  $\text{NH}_3$  concentration in room 9 seemed to show much less variation, except for the rise of  $\text{NH}_3$  levels which was investigated at the end of the first day when the ventilation rate was increasing. The unique characteristic of this pattern was that higher  $\text{NH}_3$  concentration corresponding to higher ventilation rate was probably due to more gas generated from faecal materials and accumulated inside the room (Ni et al., 2000a). The  $\text{NH}_3$  concentrations from room 10 within the range of 15 to 28 ppm were much higher than the concentrations from room 9 with the range of 7 to 17 ppm.

It can be further observed that the diurnal pattern of  $\text{NH}_3$  emissions showed somewhat variations with the time, especially for room 9. The combined effect of rising  $\text{NH}_3$  concentrations and increasing ventilation rate during the end of the first sampling day resulted in an increase in  $\text{NH}_3$  emissions.

The diurnal variations of  $\text{H}_2\text{S}$  concentration and emission measurements made in rooms 9 and 10 are shown in Figure 5.7.

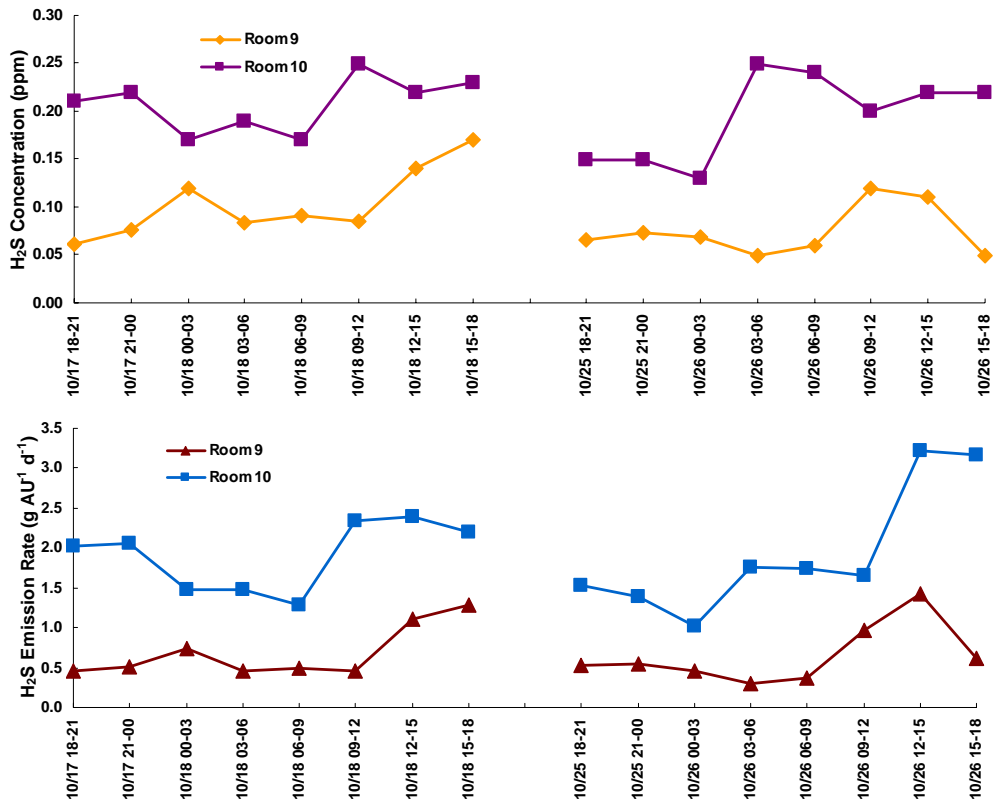

Figure 5.7 H<sub>2</sub>S concentrations and emissions for October 17 to 18 and 25 to 26, 2004.

It is interesting to observe that the variations of H<sub>2</sub>S concentrations showed a positive relationship with the ventilation rate (Figure 5.5) for both rooms in the first sampling day and for room 9 in the second day, but an inverse relationship with the ventilation rate for room 10 in the second day. This pattern change was probably due to the H<sub>2</sub>S concentrations influenced by a variety of factors like the room and ambient temperatures, the activity of the pigs and the dirtiness of the pens, not only by the ventilation rate. The H<sub>2</sub>S emissions curves were very similar to the corresponding H<sub>2</sub>S concentrations curves that were positively related to the ventilation rate since the emissions were the product of the concentrations and the ventilation rate.

The diurnal variations of CO<sub>2</sub> concentrations and emissions released from rooms 9 and 10 are shown in Figure 5.8.

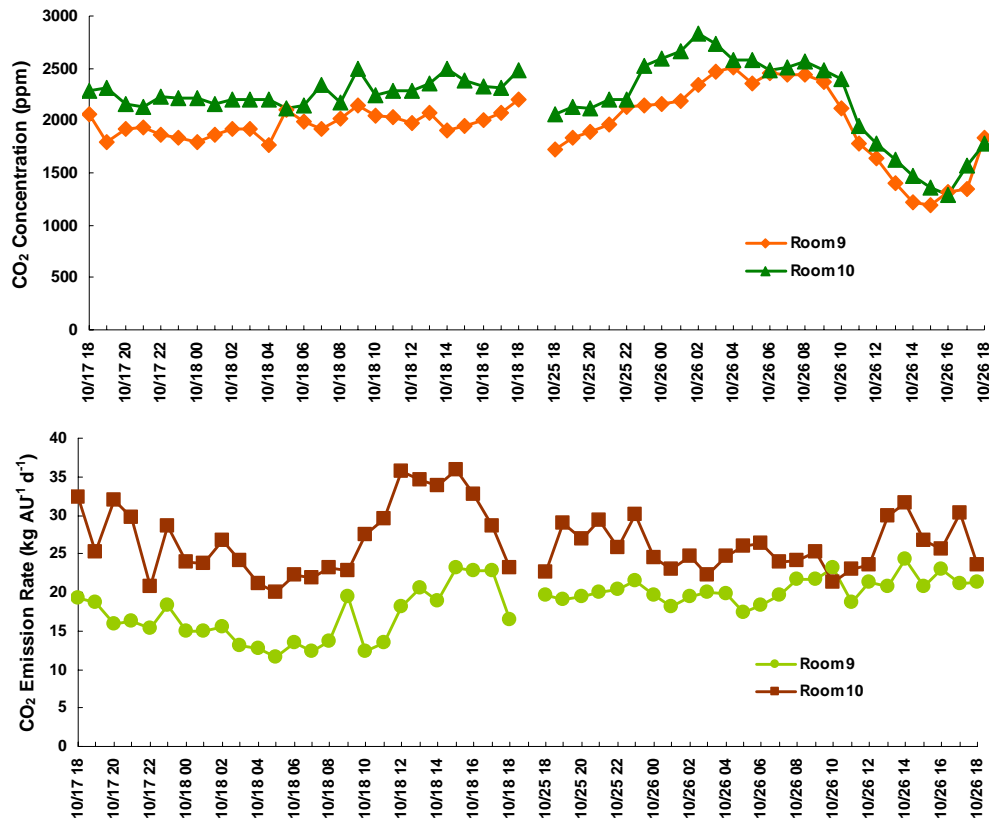

Figure 5.8 CO<sub>2</sub> concentrations and emissions for October 17 to 18 and 25 to 26, 2004.

As shown in Figure 5.8, there were more apparent diurnal variations of CO<sub>2</sub> concentrations in the second measurement day than the first day due to the larger ventilation rate fluctuation which occurred in the second day. However, the same variability in CO<sub>2</sub> emissions was not observed during that time. Rather, the CO<sub>2</sub> emissions were fairly constant since CO<sub>2</sub> concentrations were inversely related to the ventilation rate. For the first day, the fluctuation pattern of CO<sub>2</sub> emissions largely depended on the pattern of the concentrations. Higher CO<sub>2</sub> emissions which occurred at the end of the day were the result of the increase of the ventilation rate.

The hourly means, standard deviations (S.D.), and ranges of gas concentrations and emissions, ventilation rates, room and ambient temperature in October are listed for each room in Table 5.4.

Table 5.4 Hourly means, S.D. and ranges of measured variables in October.\*

Variables	Room 9			Room 10		
	Mean (S.D.)	Min	Max	Mean (S.D.)	Min	Max
NH <sub>3</sub> concentration (ppm)	11.0 (2.0)	7.0	17.0	22.0 (3.0)	15.0	28.0
NH <sub>3</sub> emission rate (g AU <sup>-1</sup> d <sup>-1</sup> )	40.5 (15.3)	17.0	77.7	103.2 (14.5)	76.9	133.3
NH <sub>3</sub> emission rate (g m <sup>-2</sup> d <sup>-1</sup> )	5.0 (2.1)	1.9	10.3	12.5 (1.9)	9.2	16.5
H <sub>2</sub> S concentration (ppm)	0.090 (0.034)	0.049	0.170	0.201 (0.037)	0.130	0.250
H <sub>2</sub> S emission Rate (g AU <sup>-1</sup> d <sup>-1</sup> )	0.67 (0.34)	0.30	1.42	1.92 (0.63)	1.01	3.22
H <sub>2</sub> S emission rate (g m <sup>-2</sup> d <sup>-1</sup> )	0.08 (0.04)	0.04	0.19	0.23 (0.08)	0.13	0.41
CO <sub>2</sub> concentration (ppm)	1966 (309)	1190	2505	2225 (335)	1295	2825
CO <sub>2</sub> emission Rate (kg AU <sup>-1</sup> d <sup>-1</sup> )	18.5 (3.3)	11.5	24.3	26.5 (4.1)	20.0	36.0
CO <sub>2</sub> emission rate (kg m <sup>-2</sup> d <sup>-1</sup> )	2.3 (0.5)	1.3	3.2	3.2 (0.5)	2.3	4.1
Ventilation rate (m <sup>3</sup> s <sup>-1</sup> )	1.90 (0.70)	0.96	4.22	2.36 (0.66)	1.65	4.38
Room temperature (°C)	18.8 (0.4)	18.3	19.8	17.9 (0.4)	17.2	18.7
Outside temperature (°C)	-1.6 (3.5)	-7.1	7.2	-1.6 (3.5)	-7.1	7.2

\*Room 9: partially slatted flooring system; Room 10: fully slatted flooring system; Number of NH<sub>3</sub>, H<sub>2</sub>S and CO<sub>2</sub> samples: 48, 16, 48 for each room, respectively.

Tables D.11 to D.13 in Appendix D provide the statistical results from the SAS output for NH<sub>3</sub>, H<sub>2</sub>S and CO<sub>2</sub> concentration in October, respectively. It was found that the NH<sub>3</sub> and H<sub>2</sub>S concentration (but not the CO<sub>2</sub> concentration) differed significantly between rooms 9 and 10; no significant diurnal variations of gas concentrations were observed in rooms 9 and 10.

Tables D.14 to D.16 in Appendix D give the statistical results from the SAS output for NH<sub>3</sub>, H<sub>2</sub>S and CO<sub>2</sub> emission in October, respectively. It was observed that the NH<sub>3</sub> and H<sub>2</sub>S emission (except for CO<sub>2</sub> emission) differed significantly between rooms 9 and 10, as well as the 'Diurnal' effect (a function of outside and room temperature, ventilation rate,

the swine management, etc.) had a significant effect on NH<sub>3</sub> emissions, CO<sub>2</sub> and H<sub>2</sub>S emissions in October.

### **5.1.3 Diurnal Odour and Gas Concentration and Emission Profiles in February**

#### **5.1.3.1 Odour Concentration and Emission**

The diurnal variation trend of ambient and room temperature, ventilation rate, odour concentrations and emissions in rooms 9 and 10 in February, 2005 are illustrated in Figure 5.9.

As the graph shows, the average ambient temperature ranged from as low as -15 °C to as high as -1.5 °C during the monitoring period; while the room temperature was quite constant. The ventilation rate still varied with the ambient temperature, but the span of variation was very small. The ventilation rate was consistently controlled within the range of 1.3-2.1 m<sup>3</sup> s<sup>-1</sup>, which supplied minimum ventilation requirement and maintained the setpoint room temperature for swine environment during cold weather. A couple of odour concentration peaks appeared when the average ambient temperature dropped off to -12 °C. Additionally, there was no apparent positive or negative correlation between the odour concentrations and the ventilation rate, except for some peak occurrences. The diurnal pattern of odour emissions was very similar to the pattern of odour concentrations due to less variation of the ventilation rate and high odour concentrations which resulted from low ventilation rate.

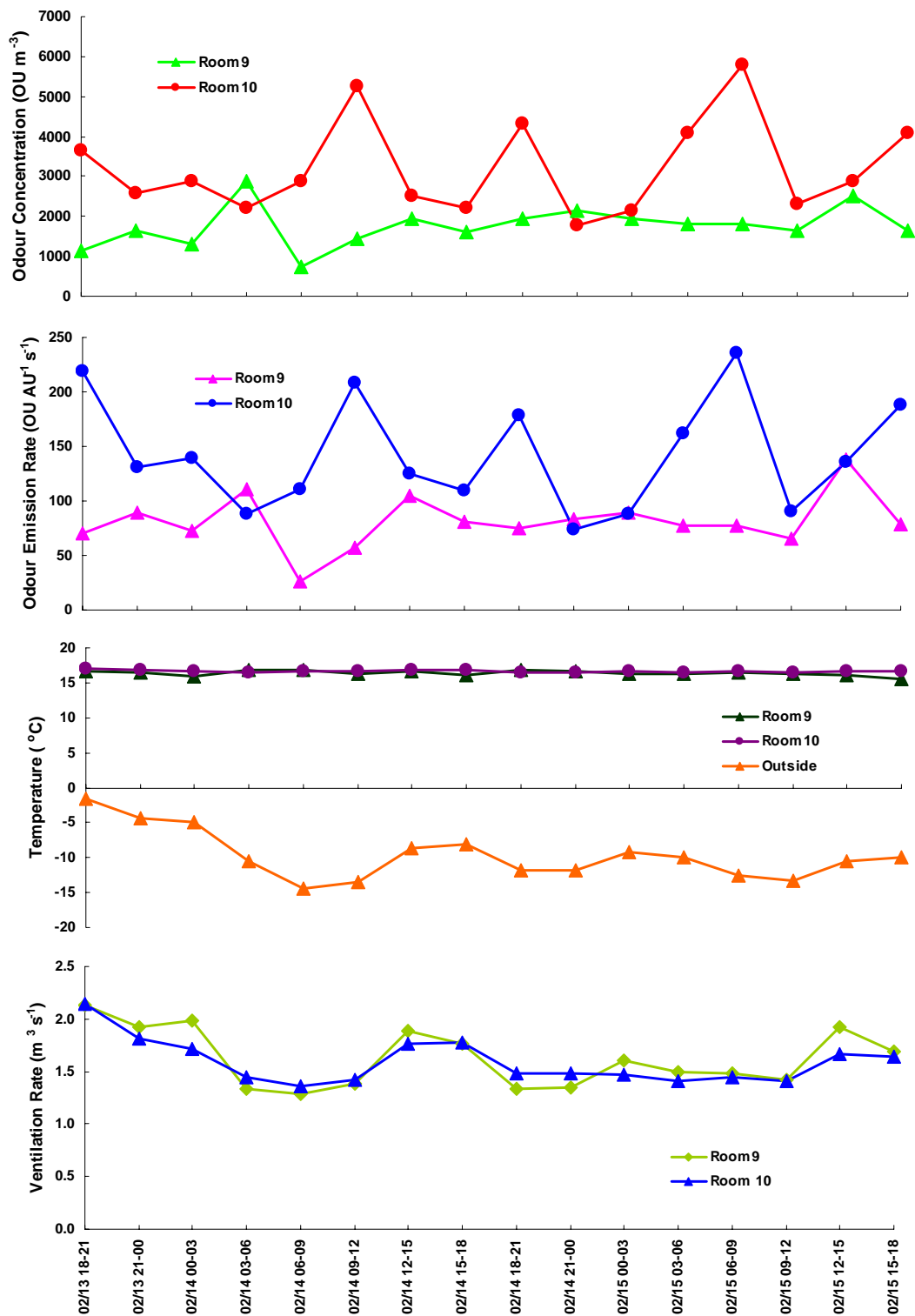

Figure 5.9 Odour concentrations, emissions, room and ambient temperature and ventilation rate for February 13 to 15, 2005.



### 5.1.3.2 Odour Concentration and Emission Statistical Analysis

The three-hour means, standard deviations (S.D.), and ranges of odour concentrations and emissions, room and ambient temperature, ventilation rates and pigs' weight are summarized for each room in Table 5.5.

Table 5.5 Three-hour means, S.D. and ranges of measured variables in February.

Variables	Room 9*			Room 10*		
	Mean (S.D.)	Min	Max	Mean (S.D.)	Min	Max
Odour concentration (OU m <sup>-3</sup> )	1683 (515)	724	2896	3040 (1184)	1765	5792
Odour emission rate (OU AU <sup>-1</sup> S <sup>-1</sup> )	77.1 (24.4)	26.7	138.4	134.5 (50.7)	73.2	235.4
Odour emission rate (OU m <sup>-2</sup> s <sup>-1</sup> )	10.8 (3.4)	3.7	19.3	19.2 (7.2)	10.4	33.6
Ventilation rate (m <sup>3</sup> s <sup>-1</sup> )	1.62 (0.30)	1.29	2.13	1.59 (0.20)	1.40	2.10
Room temperature (°C)	16.4 (0.4)	15.6	16.8	16.7 (0.2)	16.5	17.0
Outside temperature (°C)	-9.7 (3.6)	-14.4	-1.5	-9.7 (3.6)	-14.4	-1.5
Pig inventory		264			257	
Average pig mass (kg)		66.3			69.4	
Total pig mass (kg)		17500			17800	

\*Room 9: partially slatted flooring system; Room 10: fully slatted flooring system; Number of odour sample: 16 for each room.

Tables D.17 and D.18 in Appendix D provide the statistical results from the SAS output for odour concentration and emission. It was found that: (1) room 10 odour concentration was statistically higher than that of room 9; (2) no significant diurnal variation of odour concentrations was observed in rooms 9 and 10; (3) there was no interaction between the 'Flooring' factor and the 'Diurnal' factor for the odour concentration; (4) the odour emissions differed significantly between rooms 9 and 10. This significant difference could be explained by the considerable odour release reduction from partially slatted flooring system (room 9) compared with fully slatted flooring system (room 10); (5) the 'Diurnal' factor (a function of ambient and room temperature, ventilation rate, the swine management, etc.) had no significant effect on diurnal odour

emissions during cold weather, and (6) no interaction term was found within the ‘Flooring’ and ‘Diurnal’ factors for the odour emissions in February.

### 5.1.3.3 Gas Concentration and Emission and Statistical Analysis

The diurnal variations of NH<sub>3</sub> concentration and emission measurements taken from rooms 9 and 10 are shown in Figure 5.10. As the graph shows, the NH<sub>3</sub> concentrations varied diurnally with relatively high concentrations (greater than 34 ppm) and low concentrations (less than 25 ppm) for both rooms. These levels were inversely related to the ventilation rate since low air exchange rate resulted in high concentrations and the reverse case when the airflow rate was relatively high.

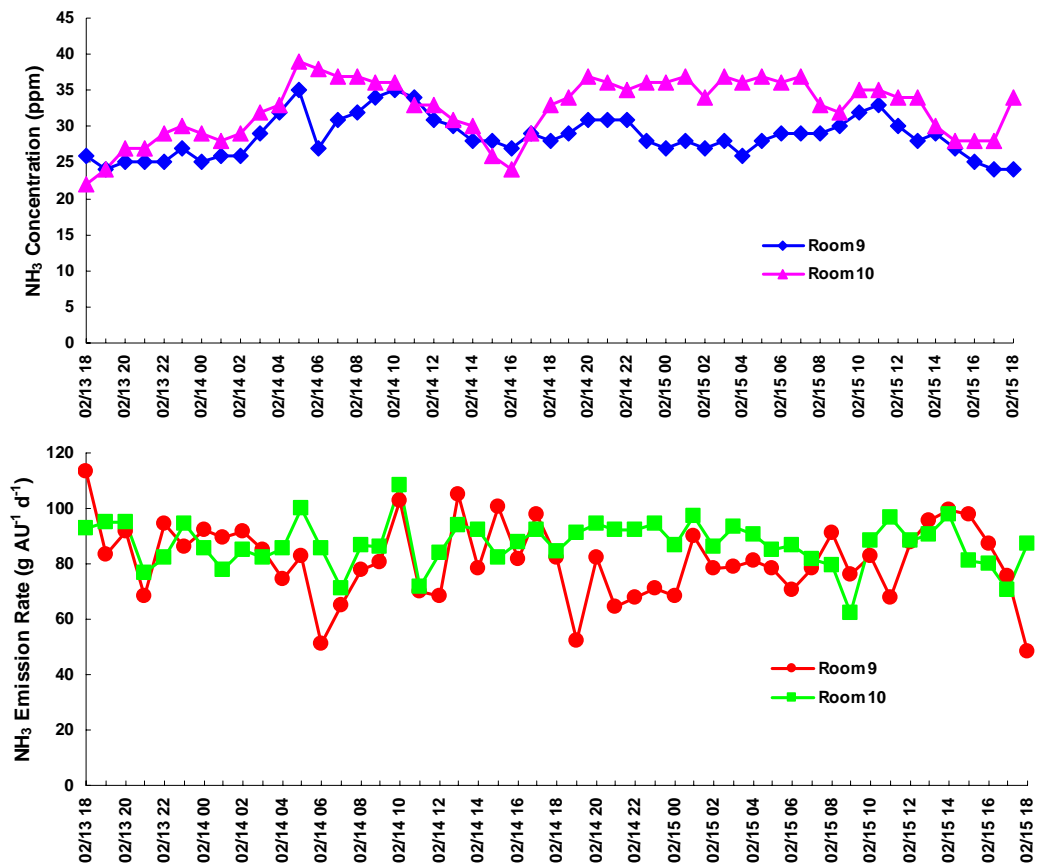

Figure 5.10 NH<sub>3</sub> concentrations and emissions for February 13 to 15, 2005.

The NH<sub>3</sub> emissions showed much less diurnal variations during the measurement period since the emissions depended on the concentrations and ventilation rate. The ventilation rate seemed to compensate for the concentrations so the emissions were fairly constant.

The diurnal variations of H<sub>2</sub>S concentration and emission measurements made in rooms 9 and 10 are shown in Figure 5.11. The H<sub>2</sub>S concentrations in two measurement days were significantly different. The levels for the first day were as low as 0.015 ppm but approaching over 0.4 ppm suddenly for the second day. This might be due to the reading error of the measuring instrument or malfunction of H<sub>2</sub>S meter. It was also observed that the patterns of H<sub>2</sub>S emission were very similar to the patterns of H<sub>2</sub>S concentrations.

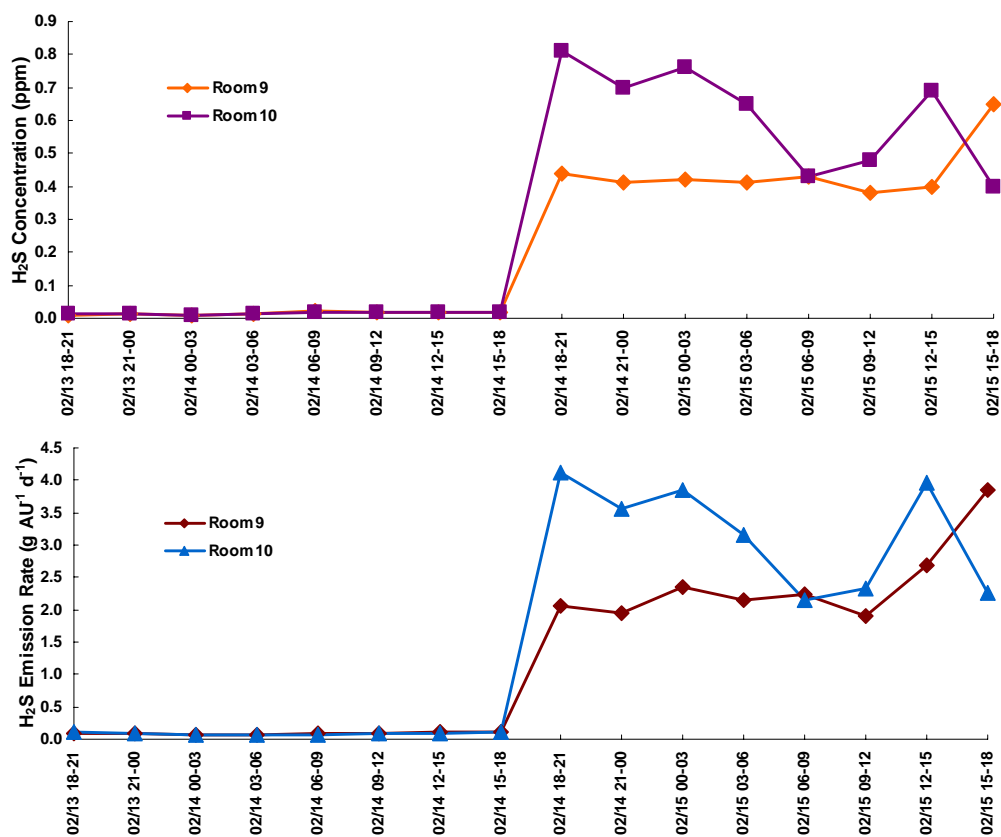

Figure 5.11 H<sub>2</sub>S concentrations and emissions for February 13 to 15, 2005.

The diurnal variations of CO<sub>2</sub> concentration and emission released from rooms 9 and 10 are shown in Figure 5.12. The fluctuation pattern was shown for the CO<sub>2</sub> concentration by only reaching 2000 ppm at the beginning of monitoring and then keeping increasing, finally arriving at maximum levels (6250 ppm for room 9 and 7045 ppm for room 10) at the end of the second day. The reason was probably due to gas accumulation in the room when minimum ventilation rates were maintained. CO<sub>2</sub> emission curves followed the trend of CO<sub>2</sub> concentrations since the CO<sub>2</sub> concentrations were much dominant than the ventilation rate in the CO<sub>2</sub> emissions.

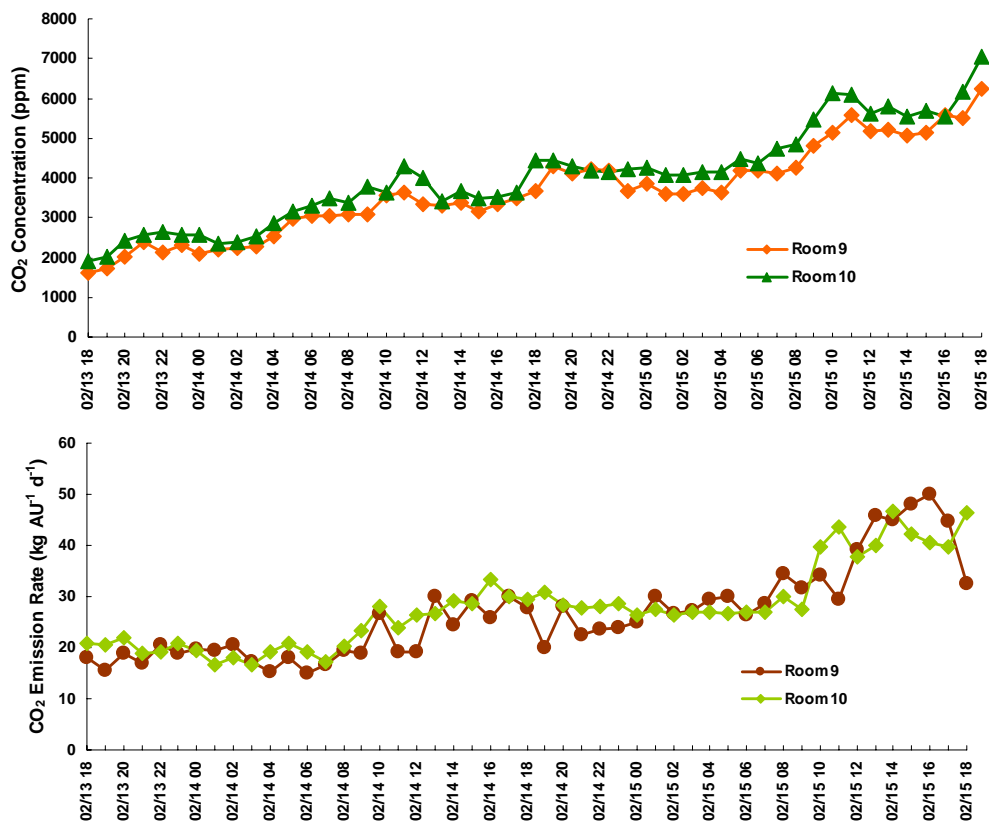

Figure 5.12 CO<sub>2</sub> concentrations and emissions for February 13 to 15, 2005.

The hourly means, standard deviations, and ranges of gas concentrations and emissions, ventilation rates, room and ambient temperature are listed for each room in Table 5.6.

Table 5.6 Hourly means, S.D. and range of measured variables in February.

Variables	Room 9			Room 10		
	Mean (S.D.)	Min	Max	Mean (S.D.)	Min	Max
NH <sub>3</sub> concentration (ppm)	27.0 (3.0)	24.0	35.0	32.0 (4.0)	22.0	39.0
NH <sub>3</sub> emission rate (g AU <sup>-1</sup> d <sup>-1</sup> )	81.4 (13.8)	48.4	113.5	87.2 (8.4)	62.2	108.3
NH <sub>3</sub> emission rate (g m <sup>-2</sup> d <sup>-1</sup> )	11.4 (1.9)	6.8	15.9	12.4 (1.2)	8.9	15.4
H <sub>2</sub> S concentration (ppm)	0.229 (0.228)	0.010	0.650	0.315 (0.328)	0.011	0.810
H <sub>2</sub> S emission Rate (g AU <sup>-1</sup> d <sup>-1</sup> )	1.20 (0.18)	0.10	3.90	1.63 (1.70)	0.07	4.12
H <sub>2</sub> S emission rate (g m <sup>-2</sup> d <sup>-1</sup> )	0.17 (1.27)	0.01	0.54	0.23 (0.24)	0.01	0.59
CO <sub>2</sub> concentration (ppm)	3647 (1126)	1615	6250	4030 (1220)	1910	7045
CO <sub>2</sub> emission Rate (kg AU <sup>-1</sup> d <sup>-1</sup> )	26.5 (9.0)	14.9	50.1	27.8 (8.0)	16.7	46.8
CO <sub>2</sub> emission rate (kg m <sup>-2</sup> d <sup>-1</sup> )	3.7(1.3)	2.1	7.0	4.0 (1.1)	2.4	6.7
Ventilation rate (m <sup>3</sup> s <sup>-1</sup> )	1.64 (0.34)	1.03	2.49	1.59 (0.26)	1.12	2.45
Room temperature (°C)	16.4 (0.5)	14.9	17.4	16.7 (0.2)	16.3	17.4
Outside temperature (°C)	-9.6 (3.8)	-15.5	1.7	-9.6 (3.8)	-15.5	1.7

\*Room 9: partially slatted flooring system; Room 10: fully slatted flooring system; Number of NH<sub>3</sub>, H<sub>2</sub>S and CO<sub>2</sub> samples: 48, 16, 48 for each room, respectively.

Tables D.19 to D.21 in Appendix D provide the statistical results from the SAS output for NH<sub>3</sub>, H<sub>2</sub>S and CO<sub>2</sub> concentration, respectively. It was found that there was no significant difference for the gas concentrations between rooms 9 and 10, as well as the ‘*Diurnal*’ factor (a function of ambient and room temperatures, ventilation rate, the swine management, etc.) had no significant effect on NH<sub>3</sub> and H<sub>2</sub>S concentration but had a significant effect on CO<sub>2</sub> concentration.

Tables D.22 to D.23 in Appendix D give the statistical results from the SAS output for NH<sub>3</sub>, H<sub>2</sub>S and CO<sub>2</sub> emission, respectively. It was observed that the gas emissions between rooms 9 and 10 did not differ significantly, as well as the ‘*Diurnal*’ factor (a function of ambient and room temperature, ventilation rate, the swine management, etc.)

had no significant effect on the NH<sub>3</sub> emissions and H<sub>2</sub>S emissions, but a significant effect on CO<sub>2</sub> emissions.

#### 5.1.4 Summary of Diurnal Odour and Gas Concentration and Emission

The means of diurnal odour and gas concentration and emission in rooms 9 and 10 during three sampling seasons are illustrated in Figures 5.13 to 5.20. The summary table is presented in Table D.25 of Appendix D.

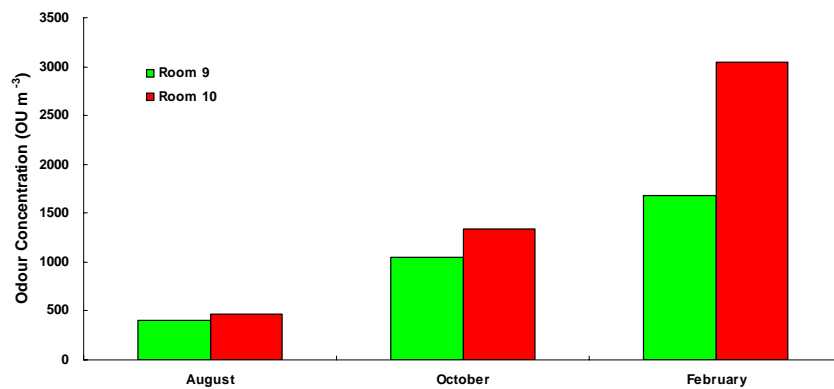

Figure 5.13 The means of diurnal odour concentrations during three measurement months.

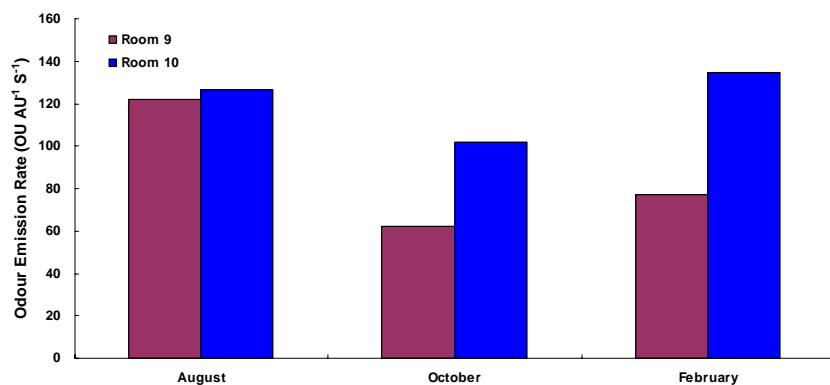

Figure 5.14 The means of diurnal Odour emissions during three measurement months.

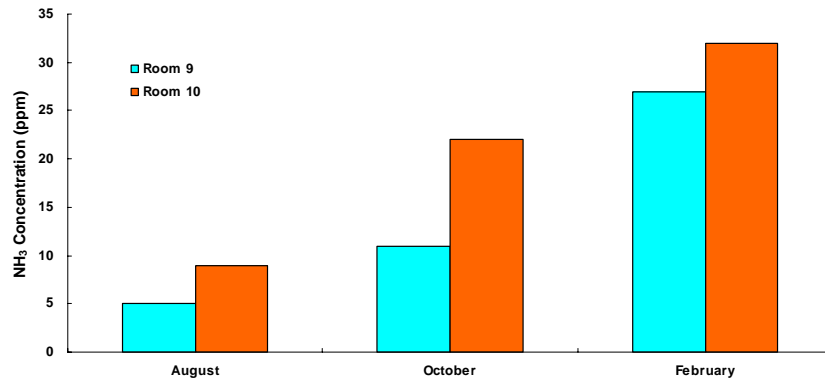

Figure 5.15 The means of diurnal  $\text{NH}_3$  concentrations during three measurement months.

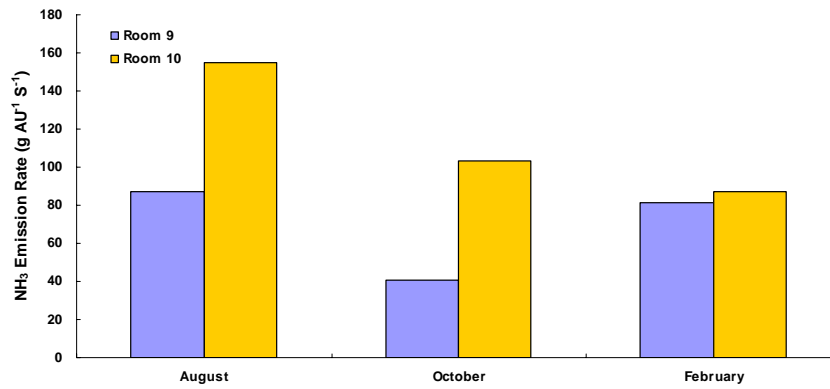

Figure 5.16 The means of diurnal  $\text{NH}_3$  emissions during three measurement months.

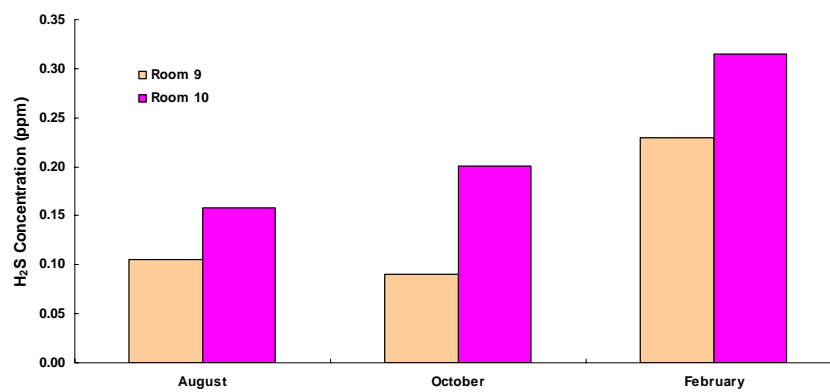

Figure 5.17 The means of diurnal  $\text{H}_2\text{S}$  concentrations during three measurement months.

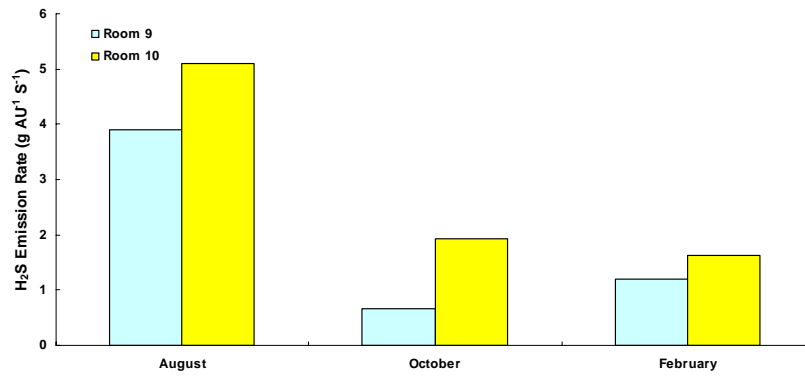

Figure 5.18 The means of diurnal H<sub>2</sub>S emissions during three measurement months.

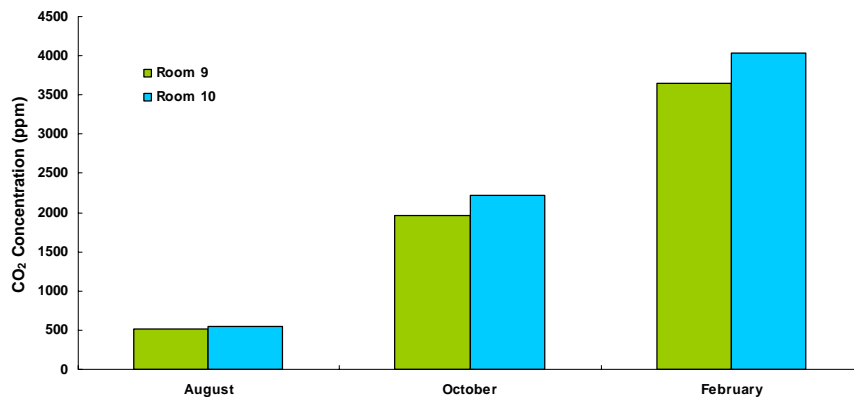

Figure 5.19 The means of diurnal CO<sub>2</sub> concentrations during three measurement months.

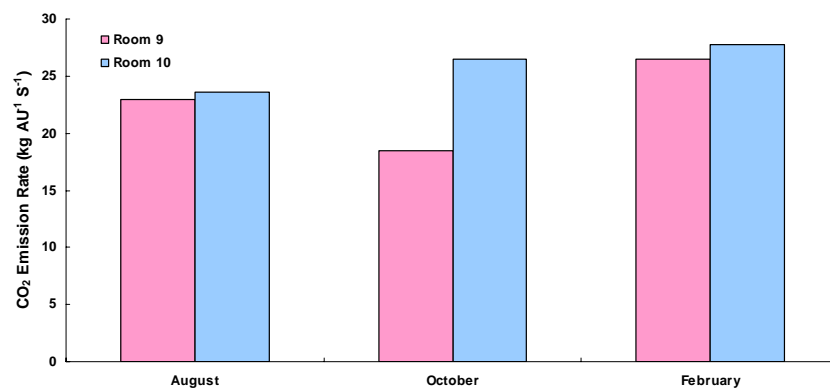

Figure 5.20 The means of diurnal CO<sub>2</sub> emissions during three measurement months.



As shown in Figures 5.13 to 5.20, obviously, room 10 odour and gas concentration and emission were higher than room 9 for three measurement seasons. Since the ventilation rate and animal units between rooms 9 and 10 were very similar, these higher concentration and emission should be due to different flooring systems. The fully slatted flooring system had larger exposed manure area than the partially slatted flooring system, which resulted in more odour and gas release. Thus, it can be concluded that partially slatted flooring systems could reduce odour and gas concentration inside the barn and the rate of emission to the environment as compared with fully slatted flooring systems.

The highest mean odour and gas concentration occurred in February; while the lowest odour and gas levels appeared in August. The main reason was the large differences in the ventilation rate and ambient temperature during winter and summer. Low concentrations under warm weather conditions were attributed to strong dilution effect and better indoor air mixing due to high ventilation rates; conversely, low ventilation rate during cold weather caused odour and gas accumulation inside the swine room. Therefore, it can be concluded that the ventilation rate plays a key role in indicating odour and gas concentration.

During a majority of measurement periods, the odour concentration was inversely related to the ventilation rate and ambient temperature. However, it was not the case when the ventilation rate was maintained at relatively steady level, e.g. in the summer when the ventilation rate was at its maximum value and in the winter when the

ventilation rate variation was very small. The odour concentrations could be positively or inversely correlated with the ventilation rate; even some spikes were often observed. These changes might be caused by some activities that resulted in more odour release, such as increase of animal activities, disturbing animals by stockman working inside the room, etc. Thus, it should be concluded that any activities in swine rooms when or before the air samples were taken may have more and less effect on the measured odour concentration.

Generally, the diurnal variations of  $\text{NH}_3$  levels were inversely related to the variations of the ventilation rate. However, it was observed in the afternoon in October that higher  $\text{NH}_3$  concentration in room 9 corresponded to higher ventilation rate. This was probably due to more gas generated from faecal materials and accumulated inside the room. It is interesting to note that the diurnal patterns of  $\text{H}_2\text{S}$  concentrations during three measurement seasons presented three different relationships with the ventilation rate and ambient temperature. In August, although the fluctuation of the ventilation rate was large, there seemed to be less diurnal variations in  $\text{H}_2\text{S}$  concentrations for both rooms. In October, the variations of  $\text{H}_2\text{S}$  concentration showed a positive relationship with the ventilation rate for both rooms in the first sampling day and for room 9 in the second day, but an inverse relationship with the ventilation rate for room 10 in the second day. In February,  $\text{H}_2\text{S}$  concentration in both rooms in two sampling days differed significantly. The levels for the first day were as low as around 0.015 ppm but increased over 0.4 ppm for the second day. This may be due to the reading error of the measuring instrument or malfunction of  $\text{H}_2\text{S}$  meter. The  $\text{CO}_2$  concentration showed diurnal

variations that reversely related to the ventilation rate and ambient temperature, except for during cold weather.

Statistical t-test method was used to compare the means of odour and gas concentration and emission for three measurement seasons. The comparison results are given in Table 5.7.

Table 5.7 Mean comparison of odor and gas concentration and emission during three measurement seasons.

<b>Variables</b>	<b>Month</b>	<b>Room 9</b>	<b>Room 10</b>
Odour concentration	Aug - Oct	S	S
	Oct - Feb	S	S
	Aug - Feb	S	S
Odour emission rate	Aug - Oct	S	NS
	Oct - Feb	NS	S
	Aug - Feb	S	NS
NH <sub>3</sub> concentration	Aug - Oct	S	S
	Oct - Feb	S	S
	Aug - Feb	S	S
NH <sub>3</sub> emission rate	Aug - Oct	S	S
	Oct - Feb	S	S
	Aug - Feb	NS	S
H <sub>2</sub> S concentration	Aug - Oct	NS	NS
	Oct - Feb	S	NS
	Aug - Feb	S	NS
H <sub>2</sub> S emission rate	Aug - Oct	S	S
	Oct - Feb	NS	NS
	Aug - Feb	S	S
CO <sub>2</sub> concentration	Aug - Oct	S	S
	Oct - Feb	S	S
	Aug - Feb	S	S
CO <sub>2</sub> emission rate	Aug - Oct	S	S
	Oct - Feb	S	NS
	Aug - Feb	S	S

Note: 'S' means that the concentration or emission between the two measuring months differed significantly; 'NS' means that there was no significant difference for those two months.

As shown in Table 5.7, although the odour and gas concentration (except for the H<sub>2</sub>S concentration) were significantly different under different climate conditions, as well as the ventilation rates being quite different for most of the sampling period (Table D.25), odour and gas emissions were not significant different for all three measurement seasons when expressed on per animal unit or per square metre bases, i.e., the variability in odour and gas emissions was relatively small for each room. This is mainly because the odour or gas emission rate is calculated by multiplying building ventilation rate by the odour or gas concentration and these two factors had an inverse relationship.

Table 5.8 provides the effects of ‘Flooring’ and ‘Diurnal’ factors on the diurnal odour and gas concentration and emission from rooms 9 and 10 during three measurement seasons.

Table 5.8 Effects of ‘Flooring’ and ‘Diurnal’ factors on the odour and gas concentration and emission during three sampling seasons.

Variables	Flooring Factor			Diurnal Factor		
	August	October	February	August	October	February
Odour concentration	NS	NS	S	NS	NS	NS
Odour emission rate	NS	NS	S	S	NS	NS
NH <sub>3</sub> concentration	S	S	NS	S	NS	NS
NH <sub>3</sub> emission rate	NS	S	NS	S	S	NS
H <sub>2</sub> S concentration	NS	S	NS	S	NS	NS
H <sub>2</sub> S emission rate	NS	S	NS	NS	S	NS
CO <sub>2</sub> concentration	NS	NS	NS	S	NS	S
CO <sub>2</sub> emission rate	NS	NS	NS	S	S	S

Note: ‘S’ means that the ‘flooring’ and ‘Diurnal’ factors had a significant effect on the concentration or emission from rooms 9 and 10; ‘NS’ means they had no significant effects on the concentration or emission from rooms 9 and 10.

This study did not find significant differences in odour and gas concentrations and emissions (except for the NH<sub>3</sub> concentration) between rooms 9 and 10 in August; conversely, in February, only odour concentrations and emissions differed significantly between those two rooms. In October, there were no significant differences in odour and CO<sub>2</sub> concentrations and emissions between rooms 9 and 10 (note: there seems a disagreement between the SAS analysis and the measurements that the Figures 5.14 and 5.20 are showing. This is probably explained by the fact that a set of data was limited and standard deviations were large).

It was found that significant diurnal variations in odour and gas concentrations and emissions (except for odour concentration and H<sub>2</sub>S emission) were observed in August; while in February, only CO<sub>2</sub> concentrations and emissions showed significant fluctuation patterns. In October, the significant diurnal fluctuations of gas emissions have been found.

Pearson correlation matrices (Townend, 2002) were computed to determine possible correlations of odour, NH<sub>3</sub>, H<sub>2</sub>S, and CO<sub>2</sub> concentrations under different weather conditions.

Table 5.9 Pearson correlation matrix coefficients (r) for odour and gas concentrations under different weather conditions.

	<b>August</b>		<b>October</b>		<b>February</b>	
	<b>Room 9</b>	<b>Room 10</b>	<b>Room 9</b>	<b>Room 10</b>	<b>Room 9</b>	<b>Room 10</b>
Odour-NH <sub>3</sub>	0.23	-0.14	0.19	0.64	0.03	-0.25
Odour-H <sub>2</sub> S	-0.40	-0.27	-0.08	-0.25	0.29	0.06
Odour-CO <sub>2</sub>	-0.14	0.04	0.53	0.60	0.31	0.19

As Table 5.9 shows, in October, Pearson correlation matrix indicates a significant ( $p < 0.05$ ) moderate ( $r = 0.64$ ) correlation between odour and  $\text{NH}_3$  concentrations in room 10 and significant ( $p < 0.05$ ) moderate ( $r = 0.53$  and  $r = 0.60$ ) correlations between odour and  $\text{CO}_2$  concentrations in rooms 9 and 10, respectively. No other significant relationships between odour and gas concentrations were found in this research.

## **5.2 Seasonal Odour and Gas Concentration and Emission Profiles**

Seasonal odour and gas samples were taken from four grower/finisher rooms (rooms 6, 9, 10 and 11) over a period of 12 months from August of 2004 to July of 2005. Grab samples of odour and gas were made in the morning around 1000 h due to higher pig activities and gas generation after feeding. There were no data collected from room 6 in January because the room was empty for a new pig growth cycle during that measurement period. June sampling was also cancelled due to the unavailability of the odour lab.

### **5.2.1 Seasonal Odour and Gas Concentration and Emission**

Table 5.10 summarizes the average and standard deviation (S.D.) of odour and gas concentrations and emissions from two types of rooms in each sampling month.

Table 5.10-1 Average and standard deviation (S.D.) of odour concentrations and emissions from two types of rooms in each sampling month.

Date	Room	Troom °C	Tout °C	AU	VR m <sup>3</sup> s <sup>-1</sup>	Odour OU m <sup>-3</sup>	OER1 OU AU <sup>-1</sup> s <sup>-1</sup>	OER2 OU m <sup>-2</sup> s <sup>-1</sup>
03-Aug-04	6,9	23.8	22.2	30.6	14.9	487 <sup>(c d)</sup>	242 <sup>(a)</sup>	28.9 <sup>(a)</sup>
		(0.3)		(9.1)	(1.1)	(69)	(127.1)	(6.2)
	10,11	23.6	22.2	41.3	13.1	689 <sup>(y z)</sup>	218.9 <sup>(x)</sup>	36.0 <sup>(x)</sup>
		(0.6)		(3.9)	(0.6)	(145)	(36.3)	(9.3)
02-Sep-04	6,9	19.7	16.1	42.6	16	221 <sup>(d)</sup>	84.4 <sup>(c)</sup>	14.1 <sup>(c)</sup>
		(0.7)		(10.5)	(1.4)	(32)	(41.3)	(3.3)
	10,11	20.5	16.1	42	13.1	347 <sup>(z)</sup>	106.8 <sup>(x)</sup>	17.9 <sup>(x)</sup>
		(0.0)		(4.5)	(2.7)	(52)	(4.8)	(1.1)
18-Oct-04	6,9	18.2	-2.4	24.7	1.4	967 <sup>(b c d)</sup>	52.0 <sup>(e)</sup>	5.1 <sup>(e)</sup>
		(0.6)		(4.2)	(0.6)	(238)	(19.9)	(1.1)
	10,11	18.1	-2.4	31.6	1.9	1722 <sup>(y z)</sup>	104.2 <sup>(x)</sup>	13.1 <sup>(x)</sup>
		(0.1)		(4.2)	(0.2)	(713)	(37.6)	(6.6)
21-Nov-04	6,9	15.3	-6.5	43.4	2.2	1663 <sup>(b)</sup>	87.8 <sup>(c)</sup>	16.5 <sup>(c)</sup>
		(0.4)		(5.1)	(0.4)	(-)	(-)	(-)
	10,11	14.9	-6.5	48.4	2.3	2435 <sup>(x y)</sup>	116.5 <sup>(x)</sup>	22.5 <sup>(x)</sup>
		(0.4)		(2.9)	(0.5)	(600)	(12.4)	(1.1)
19-Dec-04	6,9	15.6	-0.6	45.4	3.5	912 <sup>(b c d)</sup>	68.9 <sup>(c)</sup>	12.3 <sup>(c)</sup>
		(0.3)		(13.1)	(1.5)	(301)	(12.3)	(1.4)
	10,11	14.4	-0.6	24.1	1.3	2169 <sup>(x y z)</sup>	116.2 <sup>(x)</sup>	11.1 <sup>(x)</sup>
		(0.3)		(0.2)	(0.3)	(535)	(55.9)	(5.5)
23-Jan-05	6,9	17.3	-10.2	23	0.7	1290 <sup>(b c)</sup>	39.3 <sup>(c)</sup>	3.6 <sup>(c)</sup>
		(-)		(-)	(-)	(-)	(-)	(-)
	10,11	19.1	-10.2	25.7	1.6	2169 <sup>(x y z)</sup>	133.4 <sup>(x)</sup>	13.6 <sup>(x)</sup>
		(0.6)		(3.0)	(0.5)	(535)	(57.6)	(7.6)
14-Feb-05	6,9	16.5	-15.2	34.5	1.6	1351 <sup>(b c)</sup>	62.9 <sup>(c)</sup>	8.7 <sup>(c)</sup>
		(0.8)		(0.7)	(0.2)	(132)	(11.0)	(1.7)
	10,11	17.2	-15.2	39.3	2.1	3637 <sup>(x)</sup>	189.3 <sup>(x)</sup>	29.6 <sup>(x)</sup>
		(0.6)		(5.0)	(0.3)	(1927)	(96.2)	(11.0)
20-Mar-05	6,9	14.3	-6.5	51.7	2.6	1439 <sup>(b)</sup>	72.0 <sup>(c)</sup>	14.9 <sup>(c)</sup>
		(1.6)		(1.1)	(0.5)	(13)	(10.1)	(2.4)
	10,11	14.9	-6.5	54.4	3	2435 <sup>(x y)</sup>	132.7 <sup>(x)</sup>	28.8 <sup>(x)</sup>
		(1.1)		(4.8)	(0.8)	(600)	(59.2)	(15.6)
27-Apr-05	6,9	13.6	-0.6	14.8	1.1	2964 <sup>(a)</sup>	201.4 <sup>(a b)</sup>	11.8 <sup>(a b)</sup>
		(0.8)		(1.8)	(0.6)	(1076)	(11.8)	(2.2)
	10,11	18.9	-0.6	18.9	1	3822 <sup>(x)</sup>	208.2 <sup>(x)</sup>	15.7 <sup>(x)</sup>
		(0.1)		(2.3)	(0.04)	(1518)	(49.9)	(5.7)
25-May-05	6,9	18.9	9.8	28.5	4.0	818 <sup>(b c d)</sup>	116.6 <sup>(b c)</sup>	13.2 <sup>(b c)</sup>
		(0.9)		(4.3)	(0.4)	(142)	(51.6)	(3.7)
	10,11	19	9.8	35.4	5.0	1370 <sup>(y z)</sup>	194.5 <sup>(x)</sup>	27.4 <sup>(x)</sup>
		(0.1)		(3.7)	(0.6)	(276)	(3.8)	(2.4)
05-Jul-05	6,9	26.5	23.7	51.8	14.9	480 <sup>(c d)</sup>	138.1 <sup>(b c)</sup>	28.5 <sup>(b c)</sup>
		(1.1)		(6.4)	(2.2)	(117)	(72.5)	(11.3)
	10,11	26.3	23.7	52.1	14.9	422 <sup>(y z)</sup>	121.3 <sup>(x)</sup>	25.2 <sup>(x)</sup>
		(0.4)		(3.7)	(0.5)	(110)	(18.8)	(5.7)
Annual mean	6,9	18.2	23.7	35.5	5.7	1145	105.9	14.3
		(4.0)		(13.2)	(12.3)	(6.2)	(752)	(64.3)
	10,11	18.8	23.7	37.6	5.4	1929	149.3	21.9
		(3.7)	(13.2)	(11.7)	(5.5)	(1175)	(43.9)	(8.2)

Note: Troom: Room temperature; Tout: Outside temperature; AU: Animal units; VR: Ventilation rate; ER: Emission Rate. Means with the same letter designator are not significantly different at the  $p < 0.05$  level per Duncan's Multiple range Test within each month. Letters a, b, c, d, e and f are used for rooms 6 and 9; Letters x, y, z, u, v and w are used for rooms 10 and 11.

Table 5.10-2 Average and standard deviation (S.D.) of gas concentrations and emissions from two types of rooms in each sampling month.

Date	Room	NH <sub>3</sub> ppm	NH <sub>3</sub> ER1 gAU <sup>-1</sup> d <sup>-1</sup>	NH <sub>3</sub> ER2 gm <sup>2</sup> d <sup>-1</sup>	H <sub>2</sub> S ppm	H <sub>2</sub> SER1 gAU <sup>-1</sup> d <sup>-1</sup>	H <sub>2</sub> SER2 gm <sup>2</sup> d <sup>-1</sup>	CO <sub>2</sub> ppm	CO <sub>2</sub> ER1 kgAU <sup>-1</sup> d <sup>-1</sup>	CO <sub>2</sub> ER2 Kg m <sup>2</sup> d <sup>-1</sup>
03-Aug-04	6,9	5 <sup>(e f)</sup>	146.1 <sup>(a)</sup>	16.5 <sup>(a)</sup>	0.114 <sup>(b)</sup>	7.1 <sup>(a)</sup>	0.83 <sup>(a)</sup>	398 <sup>(f)</sup>	32.0 <sup>(a)</sup>	3.8 <sup>(a)</sup>
		(1)	(74.2)	(3.8)	(0.008)	(2.1)	(0.01)	(25)	(9.8)	(0.1)
	10,11	7 <sup>(u v)</sup>	137.2 <sup>(x y)</sup>	22.4 <sup>(x y)</sup>	0.139 <sup>(y)</sup>	5.5 <sup>(x)</sup>	0.89 <sup>(x)</sup>	483 <sup>(w)</sup>	24.3 <sup>(y z)</sup>	4.0 <sup>(y z)</sup>
		(1)	(33.6)	(3.5)	(0.004)	(0.1)	(0.07)	(18)	(0.2)	(0.3)
02-Sep-04	6,9	3 <sup>(f)</sup>	57.3 <sup>(b)</sup>	9.7 <sup>(b)</sup>	0.059 <sup>(b)</sup>	2.8 <sup>(b)</sup>	0.46 <sup>(b)</sup>	295 <sup>(f)</sup>	17.6 <sup>(b c)</sup>	3.0 <sup>(b c)</sup>
		(1)	(2.8)	(1.9)	(0.002)	(0.8)	(0.02)	(64)	(2.1)	(0.4)
	10,11	6 <sup>(v)</sup>	112.4 <sup>(x y z)</sup>	18.8 <sup>(x y z)</sup>	0.093 <sup>(y z)</sup>	3.6 <sup>(y)</sup>	0.59 <sup>(y)</sup>	330 <sup>(w)</sup>	16.2 <sup>(u v)</sup>	2.8 <sup>(u v)</sup>
		(1)	(15.1)	(0.5)	(0.011)	(0.1)	(0.05)	(28)	(3.1)	(0.8)
18-Oct-04	6,9	11 <sup>(c d e f)</sup>	36.9 <sup>(b)</sup>	3.6 <sup>(b)</sup>	0.083 <sup>(b)</sup>	0.6 <sup>(c d e)</sup>	0.06 <sup>(c d e)</sup>	2038 <sup>(c)</sup>	19.0 <sup>(b c)</sup>	1.8 <sup>(b c)</sup>
		(3)	(13.1)	(0.6)	(0.004)	(0.3)	(0.02)	(18)	(11.0)	(0.8)
	10,11	26 <sup>(y)</sup>	96.1 <sup>(x y z u)</sup>	12.3 <sup>(x y z u)</sup>	0.305 <sup>(x)</sup>	2.3 <sup>(z u)</sup>	0.29 <sup>(z u)</sup>	2138 <sup>(y z)</sup>	20.6 <sup>(z u)</sup>	2.6 <sup>(z u)</sup>
		(4)	(10.9)	(3.0)	(0.078)	(0.5)	(0.10)	(301)	(3.9)	(0.1)
21-Nov-04	6,9	13 <sup>(b c d e)</sup>	40.4 <sup>(b)</sup>	7.1 <sup>(b)</sup>	0.050 <sup>(b)</sup>	0.3 <sup>(d e)</sup>	0.05 <sup>(d e)</sup>	2068 <sup>(c)</sup>	16.5 <sup>(c)</sup>	2.9 <sup>(c)</sup>
		(3)	(11.6)	(2.8)	(0.007)	(0.0)	(0.00)	(60)	(1.6)	(0.6)
	10,11	16 <sup>(z)</sup>	47.8 <sup>(u)</sup>	9.3 <sup>(u)</sup>	0.050 <sup>(y z)</sup>	0.3 <sup>(v)</sup>	0.06 <sup>(v)</sup>	2278 <sup>(y z)</sup>	17.3 <sup>(u v)</sup>	3.4 <sup>(u v)</sup>
		(3)	(14.8)	(3.4)	(0.001)	(0.0)	(0.01)	(124)	(1.5)	(0.5)
19-Dec-04	6,9	16 <sup>(b c d)</sup>	68.5 <sup>(a b)</sup>	11.4 <sup>(a b)</sup>	0.029 <sup>(b)</sup>	0.3 <sup>(d e)</sup>	0.05 <sup>(d e)</sup>	1473 <sup>(d)</sup>	17.7 <sup>(b c)</sup>	3.3 <sup>(b c)</sup>
		(11)	(38.7)	(3.4)	(0.006)	(0.0)	(0.01)	(88)	(3.7)	(1.6)
	10,11	28 <sup>(y)</sup>	90.7 <sup>(y z u)</sup>	8.8 <sup>(y z u)</sup>	0.036 <sup>(z)</sup>	0.3 <sup>(v)</sup>	0.03 <sup>(v)</sup>	1503 <sup>(u)</sup>	13.0 <sup>(v)</sup>	1.3 <sup>(v)</sup>
		(2)	(13.6)	(1.3)	(0.001)	(0.1)	(0.01)	(67)	(3.5)	(0.4)
23-Jan-05	6,9	19 <sup>(b c)</sup>	35.5 <sup>(b)</sup>	3.3 <sup>(b)</sup>	0.024 <sup>(b)</sup>	0.1 <sup>(e)</sup>	0.01 <sup>(e)</sup>	2945 <sup>(b)</sup>	14.2 <sup>(c)</sup>	1.3 <sup>(c)</sup>
		(-)	(-)	(-)	(-)	(-)	(-)	(-)	(-)	(-)
	10,11	36 <sup>(x)</sup>	135.3 <sup>(x y)</sup>	14.1 <sup>(x y)</sup>	0.026 <sup>(z)</sup>	0.2 <sup>(v)</sup>	0.03 <sup>(v)</sup>	3190 <sup>(x)</sup>	31.2 <sup>(x)</sup>	3.3 <sup>(x)</sup>
		(1)	(26.9)	(4.3)	(0.001)	(0.0)	(0.01)	(156)	(4.0)	(0.8)
14-Feb-05	6,9	33 <sup>(a)</sup>	94.8 <sup>(a b)</sup>	13.1 <sup>(a b)</sup>	0.018 <sup>(b)</sup>	0.1 <sup>(e)</sup>	0.02 <sup>(e)</sup>	3847 <sup>(a)</sup>	28.3 <sup>(a b)</sup>	3.9 <sup>(a b)</sup>
		(3)	(15.3)	(2.4)	(0.001)	(0.0)	(0.01)	(422)	(0.9)	(0.0)
	10,11	36 <sup>(x)</sup>	113.4 <sup>(x y z)</sup>	17.8 <sup>(x y z)</sup>	0.017 <sup>(z)</sup>	0.1 <sup>(v)</sup>	0.02 <sup>(v)</sup>	3387 <sup>(x)</sup>	27.9 <sup>(x y)</sup>	4.4 <sup>(x y)</sup>
		(1)	(0.1)	(2.3)	(0.001)	(0.0)	(0.00)	(325)	(2.1)	(0.2)
20-Mar-05	6,9	23 <sup>(b)</sup>	70.9 <sup>(a b)</sup>	14.7 <sup>(a b)</sup>	0.365 <sup>(a)</sup>	2.3 <sup>(b c)</sup>	0.48 <sup>(b c)</sup>	2260 <sup>(c)</sup>	18.2 <sup>(b c)</sup>	3.8 <sup>(b c)</sup>
		(6)	(30.0)	(6.5)	(0.148)	(1.3)	(0.27)	(262)	(4.7)	(1.1)
	10,11	23 <sup>(y)</sup>	78.1 <sup>(z u)</sup>	17.2 <sup>(z u)</sup>	0.390 <sup>(x)</sup>	2.7 <sup>(y z)</sup>	0.59 <sup>(y z)</sup>	1923 <sup>(z)</sup>	16.9 <sup>(u v)</sup>	3.7 <sup>(u v)</sup>
		(1)	(19.7)	(5.7)	(0.057)	(0.9)	(0.24)	(124)	(4.3)	(1.3)
27-Apr-05	6,9	16 <sup>(b c d)</sup>	68.4 <sup>(a b)</sup>	4.1 <sup>(a b)</sup>	0.041 <sup>(b)</sup>	0.4 <sup>(d e)</sup>	0.02 <sup>(d e)</sup>	1155 <sup>(e d)</sup>	12.7 <sup>(c)</sup>	0.8 <sup>(c)</sup>
		(1)	(22.1)	(1.8)	(0.002)	(0.2)	(0.01)	(113)	(4.0)	(0.4)
	10,11	22 <sup>(y)</sup>	72.9 <sup>(z u)</sup>	5.5 <sup>(z u)</sup>	0.096 <sup>(y z)</sup>	0.6 <sup>(v)</sup>	0.05 <sup>(v)</sup>	2448 <sup>(y)</sup>	21.0 <sup>(z u)</sup>	1.6 <sup>(z u)</sup>
		(4)	(2.9)	(0.8)	(0.076)	(0.4)	(0.04)	(421)	(0.4)	(0.2)
25-May-05	6,9	7 <sup>(d e f)</sup>	60.3 <sup>(b)</sup>	6.6 <sup>(b)</sup>	0.017 <sup>(b)</sup>	0.3 <sup>(d e)</sup>	0.04 <sup>(d e)</sup>	895 <sup>(e)</sup>	20.7 <sup>(b c)</sup>	2.3 <sup>(b c)</sup>
		(2)	(33.9)	(2.8)	(0.002)	(0.1)	(0.01)	(42)	(4.0)	(0.4)
	10,11	12 <sup>(z u)</sup>	105.8 <sup>(x y z)</sup>	14.8 <sup>(x y z)</sup>	0.021 <sup>(z)</sup>	0.4 <sup>(v)</sup>	0.06 <sup>(v)</sup>	995 <sup>(v)</sup>	22.1 <sup>(y z u)</sup>	3.2 <sup>(y z u)</sup>
		(0)	(23.2)	(1.7)	(0.001)	(0.1)	(0.01)	(226)	(0.2)	(0.4)
05-Jul-05	6,9	5 <sup>(e f)</sup>	82.6 <sup>(a b)</sup>	16.7 <sup>(a b)</sup>	0.056 <sup>(b)</sup>	2.1 <sup>(b c d)</sup>	0.43 <sup>(b c d)</sup>	300 <sup>(f)</sup>	13.3 <sup>(c)</sup>	2.8 <sup>(c)</sup>
		(1)	(34.4)	(5.0)	(0.028)	(1.6)	(0.26)	(99)	(0.8)	(0.5)
	10,11	9 <sup>(u v)</sup>	152.0 <sup>(x)</sup>	31.3 <sup>(x)</sup>	0.034 <sup>(z)</sup>	1.2 <sup>(u v)</sup>	0.25 <sup>(u v)</sup>	383 <sup>(w)</sup>	17.3 <sup>(u v)</sup>	3.6 <sup>(u v)</sup>
		(2)	(52.9)	(8.8)	(0.042)	(1.3)	(0.30)	(67)	(1.2)	(0.6)
Annual Mean	6,9	14	69.2	9.7	0.078	1.5	0.22	1607	19.1	2.7
		(9)	(31.6)	(5.1)	(0.100)	(2.1)	(0.28)	(1151)	(6.0)	(1.0)
	10,11	20	103.8	15.7	0.110	1.6	0.26	1733	20.7	3.1
		(11)	(31.0)	(7.2)	(0.125)	(1.8)	(0.30)	(1087)	(5.4)	(1.0)



The seasonal room temperature, ambient temperature and ventilation rate for four rooms are illustrated in Figure 5.21.

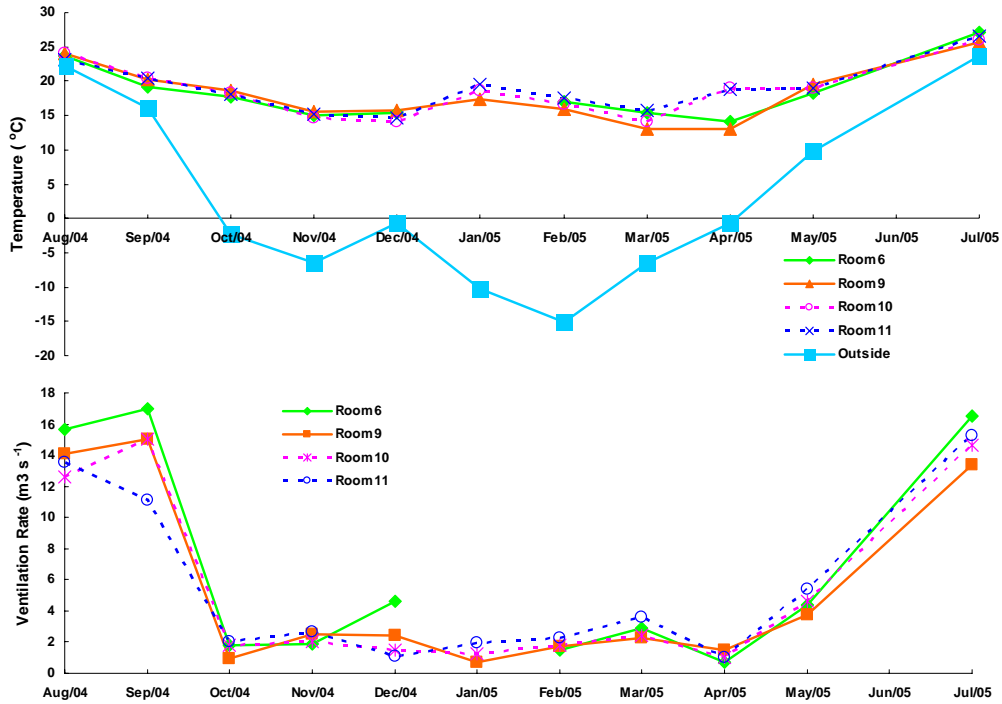

Figure 5.21 Seasonal room and ambient temperatures and ventilation rates in four rooms.

The graph shows a large fluctuation of the ambient temperature throughout the year, which varied from below  $-15\text{ }^{\circ}\text{C}$  in February up to  $24\text{ }^{\circ}\text{C}$  in July, but seasonal variations of room temperature were relatively small. During a majority of the measurement period (October 2004 to May 2005), room temperatures remained around the setpoints during each pig production cycle. However, during warm weather, room temperatures often exceeded the setpoints due to the high ambient temperature. It can be further seen that the seasonal ventilation rate curve presented a “concave” shape, with the low ventilation rate ( $0.7$  to  $4.6\text{ m}^3\text{ s}^{-1}$ ) occurring during mild and cold weather when the ambient

temperature was below 0°C as well as the high ventilation rate (11 to 17 m<sup>3</sup> s<sup>-1</sup>) during warm seasons.

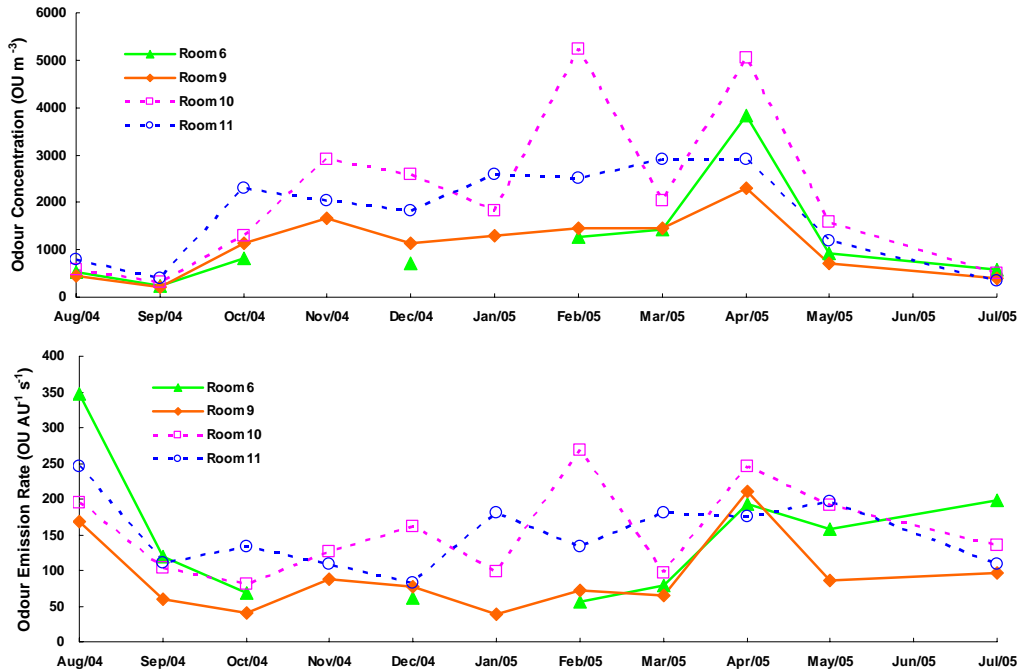

Figure 5.22 Seasonal variations of odour concentrations and emissions in four rooms.

Figure 5.22 reveals the seasonal odour concentrations and emissions in four rooms over the 12-month measuring period. As can be seen, the odour concentrations varied seasonally with relatively high concentrations from Oct. 2004 to May 2005 due to relatively low ventilation rates, as well as low concentrations in warm seasons due to high ventilation rates. Some spike concentrations were observed in April when the ambient temperature rose to -0.6°C. These spikes should be due to the fact that before the sampling, some pigs which achieved market weight had been moved to the ‘GL’ room for shipment. This process caused much more odour generation. It was also found that the odour concentration in rooms 10 and 11 was higher than rooms 6 and 9 throughout the year (annual geometric mean 1929 vs. 1145 OU m<sup>-3</sup>). The main reason

was that the fully slatted flooring systems (rooms 10 and 11) that had larger exposed manure area than partially slatted flooring systems, which resulted in more odour and gas release than partially slatted flooring systems (rooms 6 and 9).

The odour emission showed a similar seasonal trend as the odour concentration from Oct. 2004 to May 2005 since the odour emission variations largely depended on the corresponding odour levels when the fluctuation of the ventilation rate was relatively small during that period. In contrast, under warm weather conditions, because of the dominant effect of the ventilation rate, the odour emission pattern nicely followed the trend of the ventilation rate.

Figure 5.23 shows the seasonal variations of  $\text{NH}_3$  concentrations and emissions from four rooms over a 12-month monitoring period. Like odour concentrations, there was a clear seasonal cycle with high  $\text{NH}_3$  concentrations ( $> 30$  ppm) during the cold seasons and low concentrations ( $< 10$  ppm) during the warm seasons. These levels were still inversely correlated to the ventilation rates since low ventilation rates resulted in high  $\text{NH}_3$  concentrations while low concentrations were presented when the ventilation rates were high. It is interesting to observe that the  $\text{NH}_3$  levels from rooms 10 and 11 in November did not continue to increase but dropped down to around 15 ppm when the total pig weight was greater and ambient temperature was lower than the temperature in October. The main reason was due to the higher ventilation rate in November than in October as indicated in Figure 5.21. It was found that fully slatted flooring systems (rooms 10 and 11) had higher  $\text{NH}_3$  concentrations than partially slatted flooring systems

(rooms 6 and 9). One exception was that the  $\text{NH}_3$  concentrations measured in room 6 were slightly higher than the  $\text{NH}_3$  levels in rooms 10 and 11 in March. Since those rooms had essentially same ventilation rates during the monitoring period, the exception was probably attribute to the increase of pig activity in room 6 when the samples were taken.

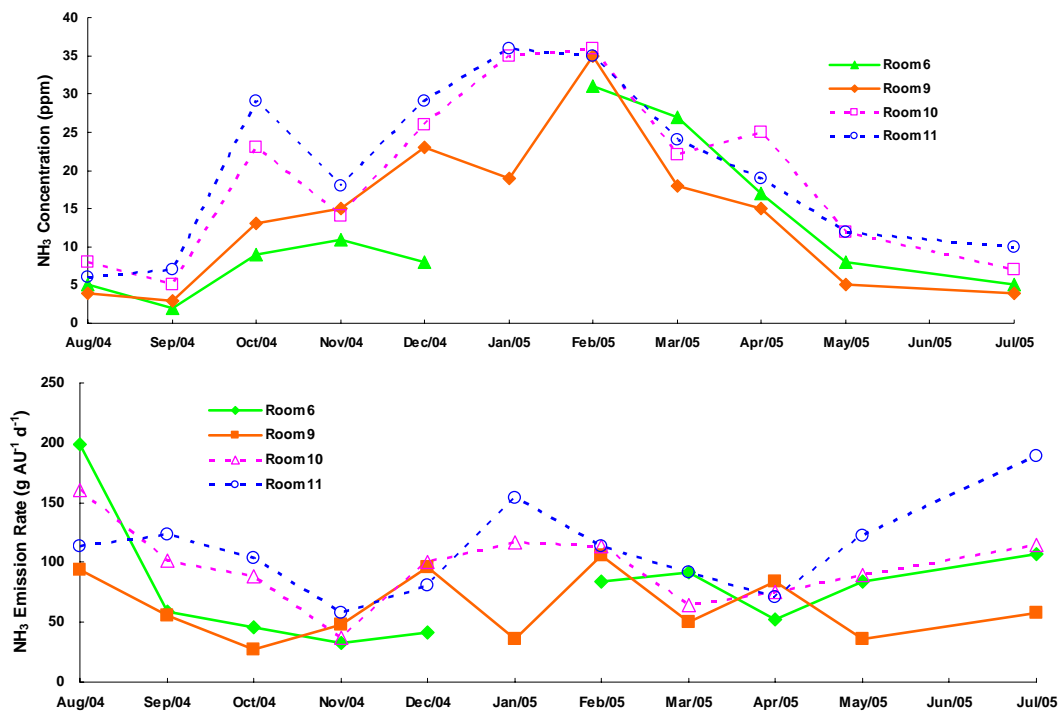

Figure 5.23 Seasonal variations of  $\text{NH}_3$  concentrations and emissions in four rooms.

As Figure 5.23 shows, there was less variation of  $\text{NH}_3$  emissions observed compared to the fluctuations of  $\text{NH}_3$  concentrations.  $\text{NH}_3$  emissions were quite constant for four pig rooms over the 12-month monitoring period since the  $\text{NH}_3$  emissions were the product of the concentrations and the ventilation rate.

Figure 5.24 reveals the seasonal variations of H<sub>2</sub>S concentrations and emissions in four rooms over a 12-month monitoring period.

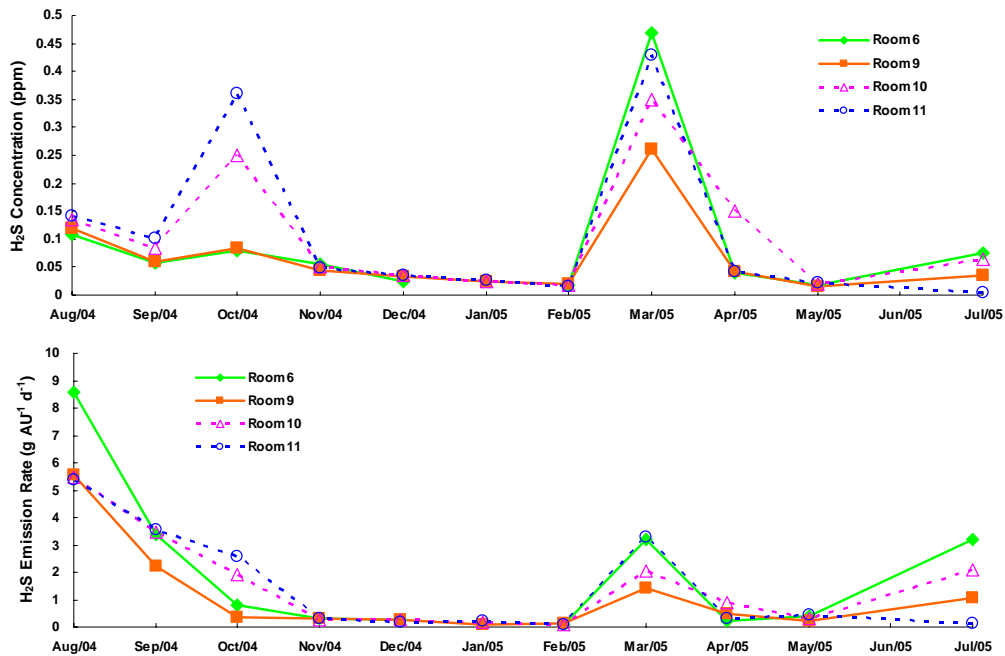

Figure 5.24 Seasonal variations of H<sub>2</sub>S concentrations and emissions in four rooms.

As the figure shows, the H<sub>2</sub>S concentrations were consistently within a range of 0.01-0.15 ppm during most of measuring period, but with two sharp peaks (0.36 ppm and 0.47 ppm) occurring in Oct. 2004 and Mar. 2005. These high H<sub>2</sub>S concentrations can be probably explained by the lowest ventilation rate in October and the highest pig weights in March compared to other sampling months. However, it should be noted the generation of H<sub>2</sub>S in pig rooms was affected by many factors, which included manure production and storage, airflow rate, manure anaerobic decomposition activity, manure disturbance, room and ambient temperature, air exchange rate in the manure storage head space, and animal total weights, etc. During the 2 or 3-minute seasonal H<sub>2</sub>S sampling period, it was hard to know which factors had significant effects on the H<sub>2</sub>S

concentrations. Thus, the seasonal H<sub>2</sub>S concentration variations showed some very interesting results especially when the ambient temperature dropped below 0°C and/or the minimum ventilation rate was maintained. It was found that lower H<sub>2</sub>S concentrations were observed in the winter instead of the summer.

The H<sub>2</sub>S emission patterns were very similar to the patterns of H<sub>2</sub>S concentrations. High emissions (1.2 to 7.1 g AU<sup>-1</sup> d<sup>-1</sup>) with relatively high ventilation rates during the warm season from June to September were observed and then decreased to lower levels (0.1 to 0.9 g AU<sup>-1</sup> d<sup>-1</sup>) from October 2004 to May 2005 (except for March 2004).

Figure 5.25 exhibits the seasonal variations of CO<sub>2</sub> concentrations and emissions in four rooms over a 12-month monitoring period.

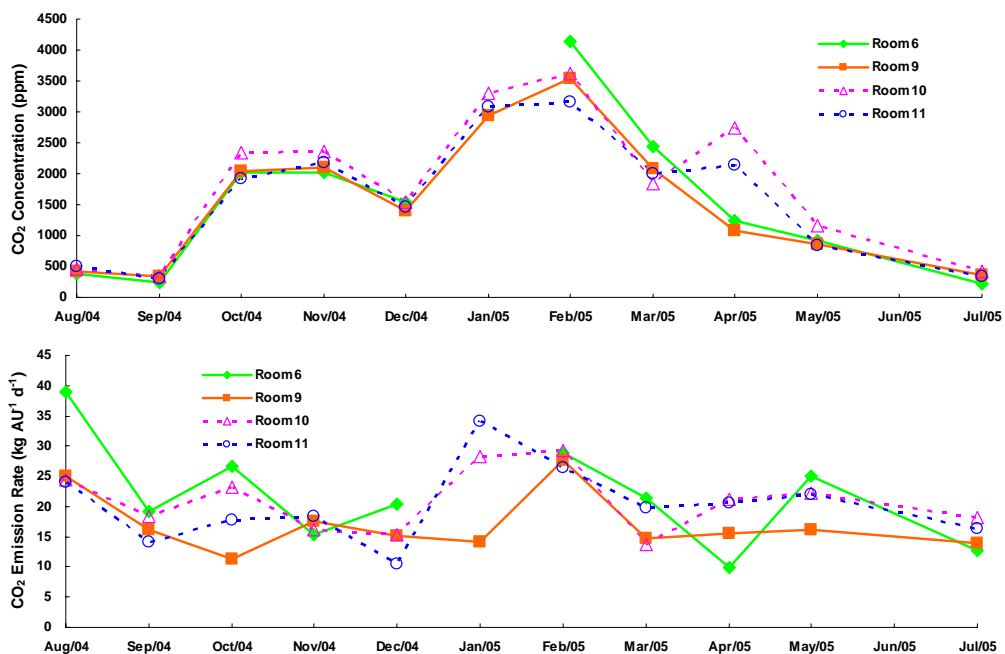

Figure 5.25 Seasonal variations of CO<sub>2</sub> concentrations and emissions in four rooms.

The fluctuations of the CO<sub>2</sub> concentrations show a very clear seasonal trend with relatively high concentrations (3000 to 3500 ppm) for four pig rooms in January and February as well as low concentrations (less than 500 ppm) in July, August and September. It can be further seen that the CO<sub>2</sub> concentrations in all rooms were quite similar except for the levels from rooms 10 and 11 in April perhaps due to the pigs' management for shipping as discussed earlier.

Although the seasonal CO<sub>2</sub> concentrations and ventilation rates were quite different for most of the sampling period, this same variability in CO<sub>2</sub> emissions was not found. Rather, the CO<sub>2</sub> emissions varied in a relatively small range of 9.9-38.9 kg AU<sup>-1</sup> d<sup>-1</sup>. The maximum value occurred in August 2004 and the minimum appeared in April 2005.

### **5.2.2 Seasonal Odour and Gas Concentration and Emission Statistical Analysis**

Seasonal odour and gas data analysis was conducted by the repeated measures method. In the SAS program, the 'Proc MIX' and 'Proc GLM' were used for developing analysis models to evaluate if the odour and gas concentrations and emissions differed significantly between the two flooring systems over a 12-month sampling period. The analysis process had two steps as discussed in Chapter 4. Three important source parameters should be specially noted and analyzed. The first is the interaction of two factors: '*Flooring*' and '*Month*' factors using a 'MIX' model. The other two are the '*Flooring*' factor and the '*Month*' factor using a 'GLM' model. The significances of the effects were determined at the 5% level.

Tables D.26 and D.27 in Appendix D give the statistical results of seasonal odour concentrations and emissions. It was found that: (1) the relative performance of the flooring systems for odour concentrations and emissions did not differ over a 12-month sampling period; (2) odour concentrations and emissions between the two different flooring systems for each measuring month did not differ significantly, and (3) the seasonal odour concentrations and emissions were significantly affected by the monitoring month.

Tables D.28 and D.29 in Appendix D present the statistical results of seasonal NH<sub>3</sub> concentrations and emissions. It was observed that: (1) the relative performance of flooring systems for the NH<sub>3</sub> concentration did change with the sampling time, but the relative performance of the flooring systems for the NH<sub>3</sub> emissions did not differ over a 12-month sampling period; (2) the '*Flooring*' factor had a significant effect on the seasonal NH<sub>3</sub> concentrations in October, November and January. During other sampling months, NH<sub>3</sub> concentrations from different flooring systems did not differ significantly; (3) the NH<sub>3</sub> emissions from different flooring systems for each measuring month did not differ significantly, and (4) the seasonal NH<sub>3</sub> concentrations and emissions were significantly affected by the monitoring month.

Tables D.30 and D.31 in Appendix D provide the statistical results of seasonal H<sub>2</sub>S concentrations and emissions. It was found that: (1) the relative performance of flooring systems for the H<sub>2</sub>S concentrations did change with the sampling time, but the relative performance of the flooring systems for H<sub>2</sub>S emissions did not differ over a 12-month



sampling period; (2) the H<sub>2</sub>S concentrations and emissions from different flooring systems in each measuring month did not differ significantly, and (3) the seasonal H<sub>2</sub>S concentrations and emissions were significantly affected by the monitoring month.

Tables D.32 and D.33 in Appendix D give the statistical results of seasonal CO<sub>2</sub> concentrations and emissions. It was found that: (1) the relative performance of flooring systems for the CO<sub>2</sub> concentrations and emissions did change with the sampling time; (2) the CO<sub>2</sub> concentrations and emissions from different flooring systems in each measuring month did not differ significantly (except for the concentration in August and the emissions in December), and (3) the seasonal CO<sub>2</sub> concentrations and emissions were significantly affected by the monitoring month.

### **5.2.3 Summary of Seasonal Odour and Gas Concentration and Emission**

It was clear to see that rooms 10 and 11 had higher odour and gas concentrations and emissions than rooms 6 and 9 for a 12-month sampling period. The main explanation was attributed to fully slatted flooring systems (rooms 10 and 11) that had larger exposure manure area than partially slatted flooring systems (rooms 6 and 9), which resulted in more odour and gas release than partially slatted flooring systems.

Table 5.11 summarizes the statistical results whether the '*Flooring*' factor and the '*Month*' factor had a significant or no significant effect on the odour and gas concentrations and emissions for the four rooms over a 12-month monitoring period.

Table 5.11 ‘Flooring’ and ‘Month’ factors on seasonal odour and gas concentrations and emissions.

<b>Variables</b>	<b>Flooring</b>	<b>Month</b>
Odor concentration	NS	S
Odor emission rate	NS	S
NH <sub>3</sub> concentration	NS (except for Oct., Nov., and Jan.)	S
NH <sub>3</sub> emission rate	NS	S
H <sub>2</sub> S concentration	NS	S
H <sub>2</sub> S emission rate	NS	S
CO <sub>2</sub> concentration	NS (except Aug.)	S
CO <sub>2</sub> emission rate	NS (except Dec.)	S

Note: S=significant; NS= no significant.

The ‘*Flooring*’ factor had no significant effect on seasonal odour and gas concentrations and emissions, except for NH<sub>3</sub> concentrations in October, November and January, CO<sub>2</sub> concentrations in August and CO<sub>2</sub> emissions in December, i.e., odour and gas concentrations and emissions between different flooring systems for each measuring month did not differ significantly. The ‘*Month*’ factor affected significantly on the seasonal odour and gas concentrations and emissions.

Although some seasonal conclusions were not completely consistent with the diurnal conclusions about the significant or insignificant effects of the factors on odour and gas concentrations and emissions, it should be noted that the seasonal conclusions were suitable for grab samples from the four rooms over the year; while the diurnal conclusions were applicable to multiple samplings during the day under different weather conditions.

### 5.3 Modelling Diurnal and Seasonal Odour and Gas Concentration and Emission

#### 5.3.2 Odour and Gas Concentration and Emission Modelling

Odour and gas concentration and emission models were separated into two parts (“partially slatted flooring” models and “fully slatted flooring” models) based on the different flooring systems of rooms 6, 9 and rooms 10, 11. Each model considered diurnal and seasonal variation, ventilation rate, ambient and room temperature, and animal units. A total of 14 prediction odour and gas models were generated as follows, ( $T_i$ =Room temperature;  $V$ =Ventilation rates;  $T_o$ =Ambient temperature;  $AU$ =Animal units).

Table 5.12 provides the SAS output results of odour and gas models for the partially slatted flooring system.

Table 5.12 SAS results of odour and gas models for the partially slatted flooring system.

Independent variable	$r^2$	C.V.	Root MSE	Ti	V	To	AU
OdourCon (OU m <sup>-3</sup> )	0.78	32.58	357.91	S	NS	S	S
OdourER (OU s <sup>-1</sup> )	0.85	22.65	769.80	S	S	S	S
NH <sub>3</sub> Con (ppm)	0.90	23.87	3.46	S	S	S	NS
NH <sub>3</sub> ER (mg s <sup>-1</sup> )	0.73	25.24	7.16	S	NS	S	NS
H <sub>2</sub> SCon (ppm)	NA	NA	NA	NA	NA	NA	NA
H <sub>2</sub> SER (mg s <sup>-1</sup> )	0.70	62.25	0.47	NS	NS	NS	NS
CO <sub>2</sub> Con (ppm)	0.88	25.36	497.41	NS	S	S	NS
CO <sub>2</sub> ER (g s <sup>-1</sup> )	0.60	23.12	2.06	NS	S	S	NS

Note: Con=concentration; ER=emission rate; S=significant ( $P < 0.05$ ); NS=not significant ( $P > 0.05$ ); NA=not available; C.V. =Coefficient of variation; Root MSE= Root of the mean square error.

1) Odour concentration (OdourCon, or OC) Model: ( $r^2 = 0.78$ )

$$OC = 12108.14 - 563.88Ti - 331.89V + 254.86To - 293.36AU - 2.87Ti * V \\ - 1.27Ti * To + 15.76Ti * AU + 8.83V * To + 6.02V * AU - 7.96To * AU$$

2) Odour emission rate (OdourER, or OE) Model: ( $r^2 = 0.85$ )

$$OE = 18533.99 - 1117.76Ti - 993.86V + 702.91To - 341.46AU + 86.83Ti * V \\ - 22.05Ti * To + 25.54Ti * AU - 7.21V * To - 11.09V * AU - 8.67To * AU$$

3) NH<sub>3</sub> Concentration (NH<sub>3</sub>Con, or NC) Model: ( $r^2 = 0.90$ )

$$NC = 55.35 - 3.01Ti + 3.88V - 3.22To - 0.42AU - 0.04Ti * V \\ + 0.07Ti * To + 0.05Ti * AU + 0.04V * To - 0.1V * AU + 0.03To * AU$$

4) NH<sub>3</sub> emission rate (NH<sub>3</sub>ER, or NE) Model: ( $r^2 = 0.73$ )

$$NE = 58.51 - 4.13Ti + 6.62V - 2.88To - 0.15AU + 0.15Ti * V \\ + 0.1Ti * To + 0.06Ti * AU - 0.12V * To - 0.14V * AU + 0.02To * AU$$

5) H<sub>2</sub>S emission rate (H<sub>2</sub>SER, or HE) Model: ( $r^2 = 0.70$ )

$$HE = -0.55 - 0.005Ti - 0.02V + 0.04To + 0.06AU + 0.02Ti * V \\ - 0.003Ti * To - 0.002Ti * AU - 0.007V * To - 0.004V * AU + 0.0006To * AU$$

6) CO<sub>2</sub> concentration (CO<sub>2</sub>Con, or CC) Model: ( $r^2 = 0.88$ )

$$CC = -516.38 + 75.72Ti + 870.18V - 627.75To + 49.9AU - 19.35Ti * V \\ + 14.55Ti * To - 1.76Ti * AU - 1.69V * To - 10.45V * AU + 6.14To * AU$$

7) CO<sub>2</sub> emission rate (CO<sub>2</sub>ER, or CE) Model: ( $r^2 = 0.60$ )

$$CE = -4.27 + 0.04Ti + 4.46V - 1.87To + 0.16AU - 0.03Ti * V \\ + 0.06Ti * To - 0.0001Ti * AU - 0.09V * To - 0.04V * AU + 0.015To * AU$$

Figure 5.26 shows the measured and predicted odour and gas concentration and emission from room 9 (the partially slatted flooring system). X axis indicates No. of samples (odour and H<sub>2</sub>S model's X axis: No.1 to 48 are diurnal data; the rest are

seasonal data. NH<sub>3</sub> and CO<sub>2</sub> model's X axis: No.1 to 144 are diurnal data; the rest are seasonal data).

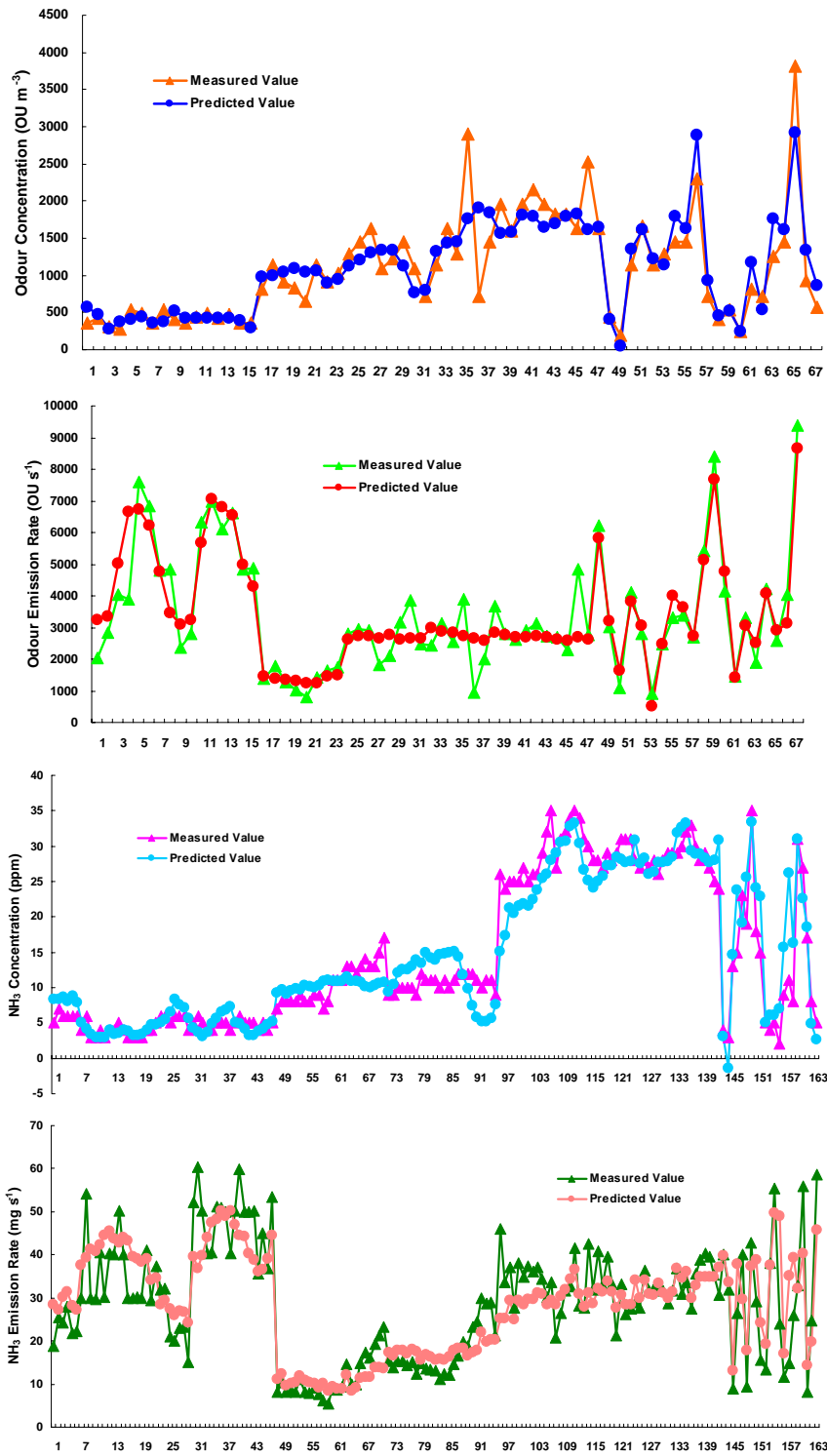

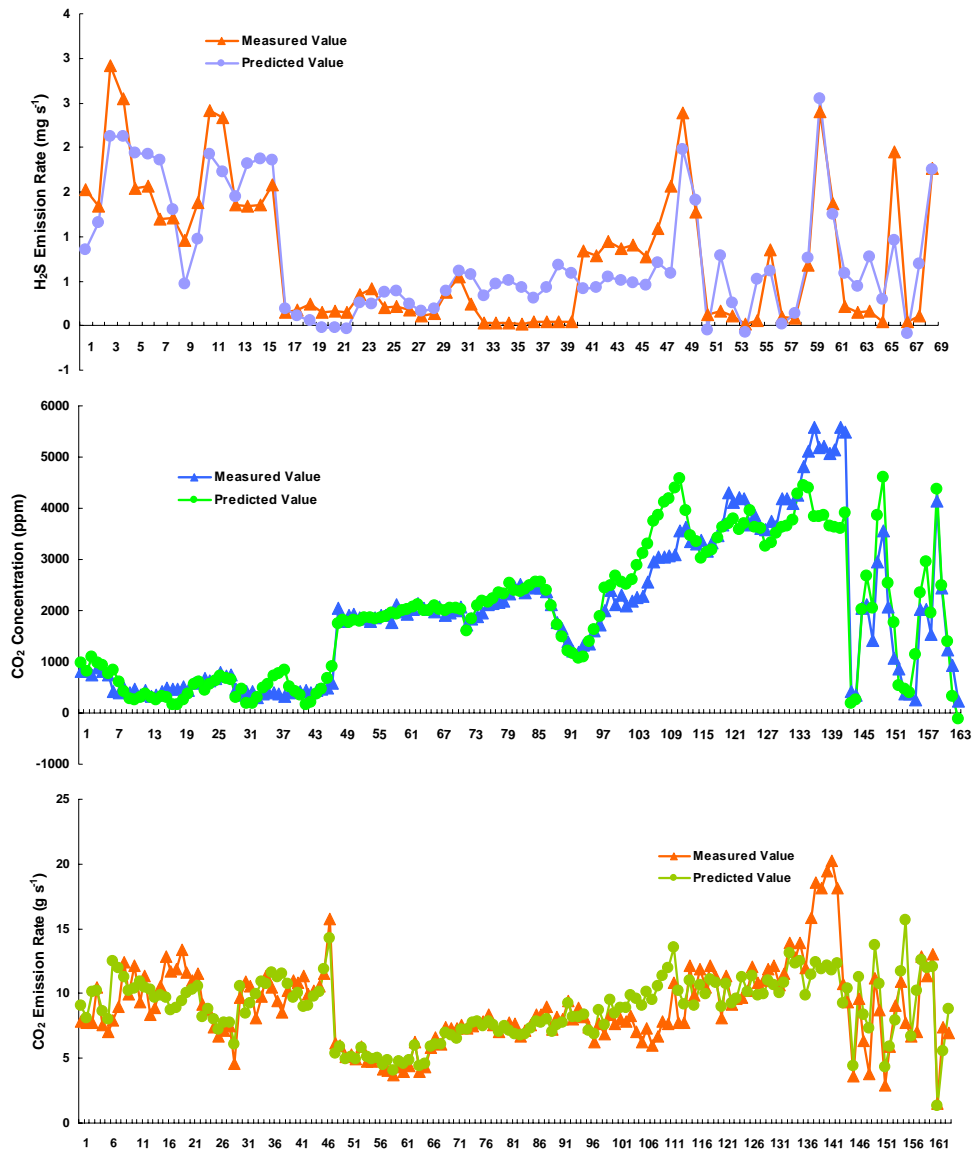

Figure 5.26 The measured vs. predicted odour and gas concentration and emission for the partially-slatted flooring system (X axis indicates No. of samples).

Table 5.13 provides the SAS results of odour and gas models for the fully slatted flooring system.

Table 5.13 SAS results of odour and gas models for the fully slatted flooring system.

Independent variable	r <sup>2</sup>	C.V.	Root MSE	Ti	V	To	AU
OdourCon (OU m <sup>-3</sup> )	0.67	47.33	852.87	NS	NS	NS	NS
OdourER (OU s <sup>-1</sup> )	0.41	32.13	1770.84	NS	NS	NS	NS
NH <sub>3</sub> Con (ppm)	0.95	10.90	2.31	S	S	NS	S
NH <sub>3</sub> ER (mg s <sup>-1</sup> )	0.90	13.06	6.12	S	S	NS	S
H <sub>2</sub> SCon (ppm)	NA	NA	NA	NA	NA	NA	NA
H <sub>2</sub> SER (mg s <sup>-1</sup> )	0.54	69.51	0.74	NS	S	NS	NS
CO <sub>2</sub> Con (ppm)	0.87	26.12	569.15	NS	S	S	S
CO <sub>2</sub> ER (g s <sup>-1</sup> )	0.50	19.26	1.96	NS	S	NS	NS

Note: Con=concentration; ER=emission rate; S=significant ( $P < 0.05$ ); NS=not significant ( $P > 0.05$ ); NA=not available; C.V. =Coefficient of variation; Root MSE= Root of the mean square error.

8) Odour concentration (OdourCon, or OC) Model: ( $r^2 = 0.67$ )

$$OC = 3440.63 + 45.82Ti + 678.09V - 324.16To - 129.29AU - 89.44Ti * V + 21.22Ti * To + 4.5Ti * AU + 31.87V * To + 14.78V * AU - 5.75To * AU$$

9) Odour emission rate (OdourER, or OE) Model: ( $r^2 = 0.41$ )

$$OE = 2147.96 + 0.47Ti + 2078.1V - 324.55To - 259.11AU - 161.32Ti * V + 33.82Ti * To + 18.44Ti * AU + 43.6V * To + 15.21V * AU - 12.64To * AU$$

10) NH<sub>3</sub> Concentration (NH<sub>3</sub>Con, or NC) Model: ( $r^2 = 0.95$ )

$$NC = 79.4 - 3.38Ti + 2.87V - 0.56To - 2.02AU - 0.16Ti * V - 0.01Ti * To + 0.13Ti * AU + 0.15V * To - 0.06V * AU - 0.01To * AU$$

11) NH<sub>3</sub> emission rate (NH<sub>3</sub>ER, or NE) Model: ( $r^2 = 0.90$ )

$$NE = 115.29 - 7.36Ti + 10.34V + 1.46To - 3.8AU + 0.31Ti * V - 0.05Ti * To + 0.27Ti * AU - 0.27V * To - 0.2V * AU - 0.02To * AU$$

12) H<sub>2</sub>S emission rate (H<sub>2</sub>SER, or HE) Model: ( $r^2 = 0.54$ )

$$HE = -3.58 + 0.15Ti + 1.43V - 0.27To + 0.02AU - 0.06Ti * V \\ + 0.01Ti * To + 0.0006Ti * AU + 0.007V * To - 0.006V * AU + 0.0005To * AU$$

13) CO<sub>2</sub> concentration (CO<sub>2</sub>Con, or CC) Model: ( $r^2 = 0.87$ )

$$CC = 5089.19 - 219.51Ti + 1105.69V - 349.26To - 215.7AU - 57.25Ti * V \\ + 8.21Ti * To + 14.53Ti * AU + 24.34V * To - 9.22V * AU + 0.01To * AU$$

14) CO<sub>2</sub> emission rate (CO<sub>2</sub>ER, or CE) Model: ( $r^2 = 0.50$ )

$$CE = 16.96 - 1.1Ti + 2.86V + 0.15To - 0.76AU + 0.01Ti * V \\ - 0.01Ti * To + 0.056Ti * AU - 0.027V * To - 0.05V * AU - 0.009To * AU$$

Figure 5.27 shows the measured and predicted odour and gas concentration and emission from room 10 (the fully slatted flooring system). X axis indicates No. of samples (odour and H<sub>2</sub>S model's X axis: No.1 to 48 are diurnal data; the rest are seasonal data. NH<sub>3</sub> and CO<sub>2</sub> model's X axis: No.1 to 144 are diurnal data; the rest are seasonal data).

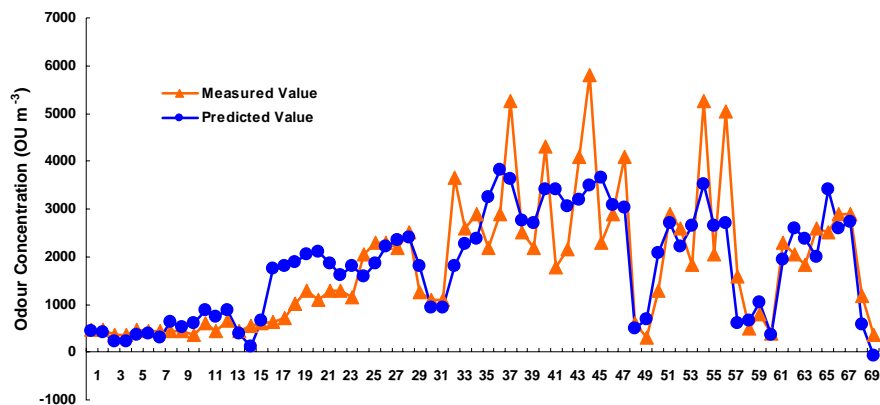



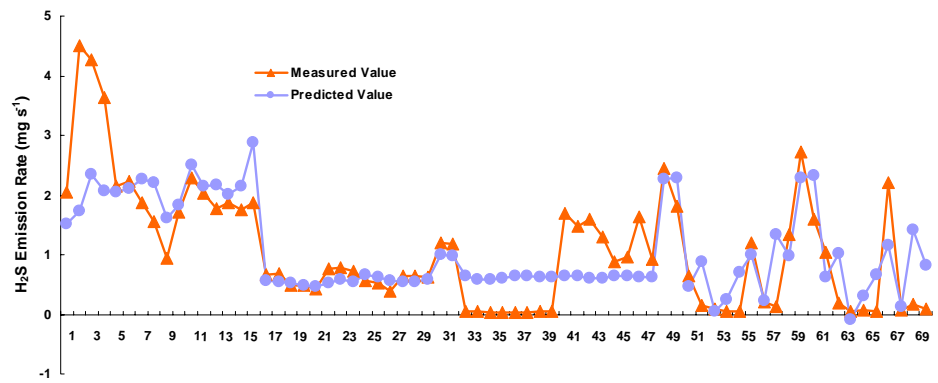
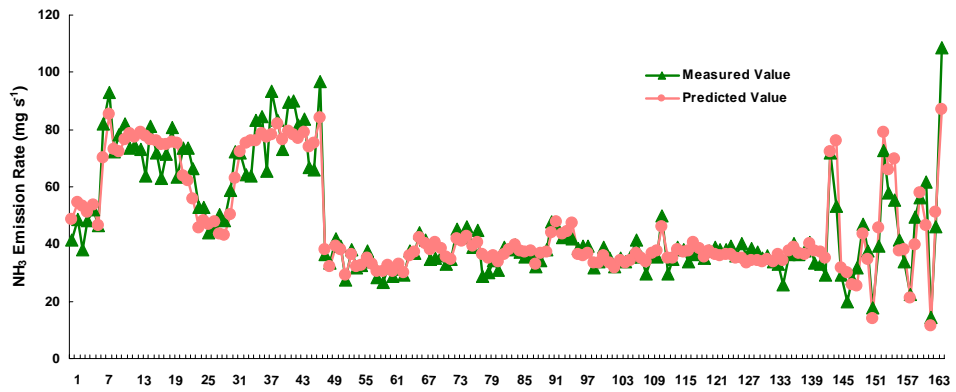
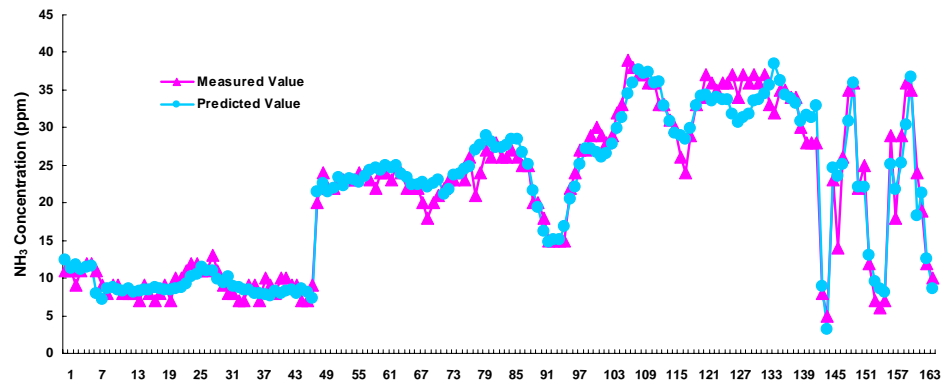
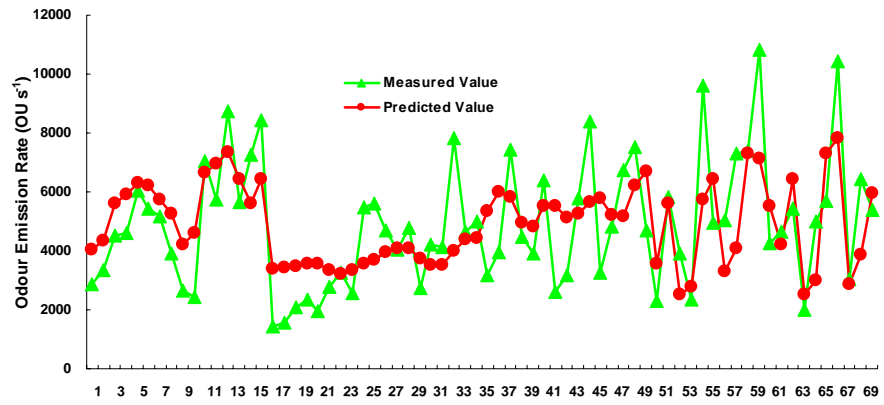

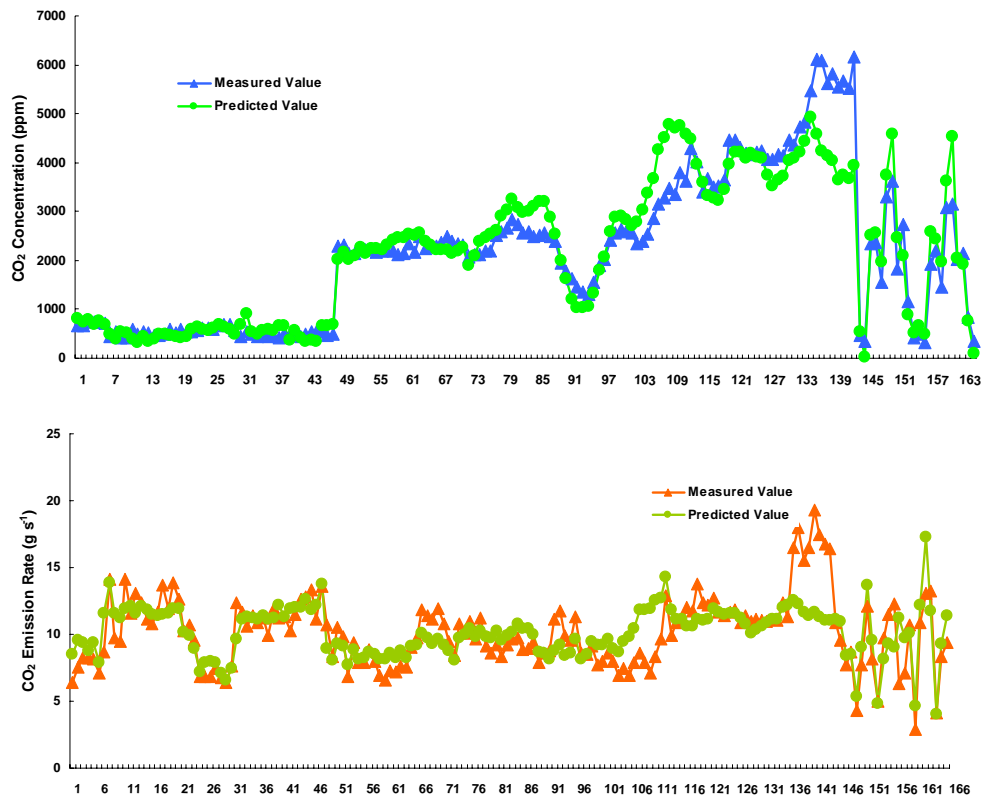

Figure 5.27 The measured vs. predicted odour and gas concentration and emission for the fully-slatted flooring system (X axis indicates No. of samples).

### 5.3.3 Summary of Odour and Gas Concentration and Emission Modelling

Table 5.14 summarizes the effects of input factors (the measured room and ambient temperatures, the ventilation rate and animal units) on odour and gas concentration and emission models.

Table 5.14 Effects of input factors on odour and gas models.\*

Model Output	Model Input	Rooms 6 and 9	Rooms 10 and 11
Odour concentration	Room temperature	S	NS
	Ventilation rate	NS	NS
	Ambient temperature	S	NS
	Animal unit	S	NS
	Model R-square	0.78	0.67
Odour emission rate	Room temperature	S	NS
	Ventilation rate	S	NS
	Ambient temperature	S	NS
	Animal unit	S	NS
	Model R-square	0.85	0.41
NH <sub>3</sub> concentration	Room temperature	S	S
	Ventilation rate	S	S
	Ambient temperature	S	NS
	Animal unit	NS	S
	Model R-square	0.9	0.95
NH <sub>3</sub> emission rate	Room temperature	S	S
	Ventilation rate	NS	S
	Ambient temperature	S	NS
	Animal unit	NS	S
	Model R-square	0.73	0.90
H <sub>2</sub> S emission rate	Room temperature	NS	NS
	Ventilation rate	NS	S
	Ambient temperature	NS	NS
	Animal unit	NS	NS
	Model R-square	0.69	0.54
CO <sub>2</sub> concentration	Room temperature	NS	NS
	Ventilation rate	S	S
	Ambient temperature	S	S
	Animal unit	NS	S
	Model R-square	0.88	0.87
CO <sub>2</sub> emission rate	Room temperature	NS	NS
	Ventilation rate	S	S
	Ambient temperature	S	NS
	Animal unit	NS	NS
	Model R-square	0.60	0.48

Note: S=significant; NS=not significant; Rooms 6 and 9 had partially slatted floorings; Rooms 10 and 11 had fully slatted floorings.

As shown in Table 5.14, some factors had more and less effects on the odour and gas concentrations and emissions. However, these factors did not always show the same

effects on the concentrations or emissions from rooms 9 and 10 due to different flooring types. According to the  $r^2$  of each model, the odour concentrations and emissions (except for room 10 emissions), the  $\text{NH}_3$  concentrations and emissions, and the  $\text{CO}_2$  concentrations can be nicely predicted by the models; while the precision of the models for the room 10 odour emissions,  $\text{H}_2\text{S}$  emissions and  $\text{CO}_2$  emissions was relatively poor. This lack of precision could be explained by the fact that odour and gas concentration and emissions depend on many factors including temperature, ventilation rates, animal units as well as the activity of the pigs and the level of pen hygiene that were not considered in the models. Therefore, animal activity and dirtiness of pens should be investigated to improve prediction precisions of odour and gas statistical models.

## **6. CONCLUSIONS AND RECOMMENDATIONS**

Ammonia, hydrogen sulphide, carbon dioxide, and odorous gaseous compounds produced by livestock facilities are a great concern in many communities throughout Canada due to their environmental and health effects on animal, workers, and nearby residents, as well as social and economic impacts on animal industry and local communities. Researchers, local units of government and livestock producers are reviewing policies and developing advanced technologies to address odour and gas problems. Up to now, a simple approach widely practiced is to maintain adequate setback distances between the livestock operation and the neighbouring residences. In order to determine science-based setback distance, air dispersion models are used to estimate downwind odour and gas concentrations from an animal source. A good prediction of downwind odour and gas using air dispersion models relies largely on source emission rate information which is highly variable with diurnal and seasonal variations, building characteristics, ventilation rate, animal size and density, weather conditions, manure handling systems, etc. Therefore, the purpose of this project was to monitor and model diurnal and seasonal odour and gas emission profiles for swine grower/finisher rooms.

## **6.1 Summary and Conclusions**

The following presents the primary conclusions drawn from the diurnal and seasonal measurements and modelling of the odour and gas concentration and emission by this research project. The diurnal conclusions were applicable to multiple samplings during the day under different weather conditions; while the seasonal conclusions were suitable for snapshot measurements from the four rooms over the year.

### **6.1.1 Diurnal Odour and Gas Concentration and Emission**

1. Odour and gas concentrations and emissions from the fully slatted flooring system (room 10) were higher than those from the partially slatted flooring system (room 9) for three measurement seasons, since the fully slatted flooring system had larger exposed manure area than the partially slatted flooring system, which resulted in more odour and gas release (average reduction between the fully and partially slatted floors: 27.6 and 30.3% for diurnal odour concentrations and emissions, respectively; 33.3 and 39.5% for diurnal NH<sub>3</sub> concentrations and emissions, respectively; 36.9 and 34.5% for diurnal H<sub>2</sub>S concentrations and emissions, respectively). However, this study did not find significant differences in odour and gas (NH<sub>3</sub>, H<sub>2</sub>S, and CO<sub>2</sub>) concentrations and emissions (except for the NH<sub>3</sub> concentration) between the two different flooring types (rooms 9 and 10) in August ( $P > 0.05$ ); while in February, only odour concentrations and emissions differed significantly between those two rooms ( $P$

< 0.05). In October, there were no significant differences in odour and CO<sub>2</sub> concentrations and emissions between rooms 9 and 10 ( $P > 0.05$ ).

2. Although the odour and gas concentrations (except for the H<sub>2</sub>S concentrations) were significantly different ( $P < 0.05$ ) under different climate conditions, as well as the ventilation rates being quite different for most of the sampling periods, odour and gas emissions did not differ significantly ( $P > 0.05$ ) for all three measurement seasons when expressed on per animal unit or per square metre bases. Again, this is mainly because the odour or gas emission rate is calculated by multiplying building ventilation rate by the odour or gas concentration and these two factors had an inverse relationship.
3. Significant diurnal variations in odour and gas (NH<sub>3</sub>, H<sub>2</sub>S, and CO<sub>2</sub>) concentrations and emissions (except for the odour concentration and H<sub>2</sub>S emission) were observed in August ( $P < 0.05$ ); while in February, only CO<sub>2</sub> concentrations and emissions showed significant fluctuation patterns ( $P < 0.05$ ). In October, significant diurnal variations ( $P < 0.05$ ) of gas (NH<sub>3</sub>, H<sub>2</sub>S, and CO<sub>2</sub>) emissions have been found.
4. Pearson correlation matrix indicated a significant ( $P < 0.05$ ) moderate ( $r = 0.64$ ) correlation between October odour and NH<sub>3</sub> concentrations from room 10 and significant ( $P < 0.05$ ) moderate ( $r = 0.53$  and  $r = 0.60$ ) correlations between October odour and CO<sub>2</sub> concentrations from rooms 9 and 10, respectively. No

other significant relationships between odour and gas concentrations were found in this research.

### **6.1.2 Seasonal Odour and Gas Concentration and Emission**

5. The fully slatted flooring systems (rooms 10 and 11) had higher seasonal odour and gas concentrations and emissions than the partially slatted flooring systems (rooms 6 and 9) for a 12-month measurement period (average reduction between fully and partially slatted floors: 40.6 and 29.1% for seasonal odour concentration and emission, respectively; 30.0 and 33.3% for seasonal NH<sub>3</sub> concentration and emission, respectively; 2.9 and 6.1% for seasonal H<sub>2</sub>S concentration and emission, respectively). However, odour and gas concentrations and emissions (except for NH<sub>3</sub> concentrations in October, November and January, CO<sub>2</sub> concentrations in August and CO<sub>2</sub> emissions in December) between different flooring systems for each measuring month did not differ significantly ( $P > 0.05$ ).
6. Seasonal odour and gas concentrations and emissions were significantly affected by the sampling month and ambient temperature ( $P < 0.05$ ). However, no specific seasonal pattern was observed.

### **6.1.3 Odour and Gas Concentration and Emission Modelling**

7. The statistical models were developed to predict diurnal and seasonal odour and gas concentrations and emissions for each flooring type as determined by room



and ambient temperatures, ventilation rates, and animal units. The models' predictions were in close agreement with measured values (except for the room 10 odour, H<sub>2</sub>S, and CO<sub>2</sub> emissions). The  $r^2$  of those models were within the range of 0.67 to 0.95.

## **6.2 Recommendations for Further Study**

1. The source odour and gas emission rates are basic and important input data for the air dispersion models to calculate setback distances between the livestock operations and the neighbouring residences. If significant diurnal variations in odour and gas emissions are found under a certain weather condition, the emissions during different intervals per measurement day must be monitored and then considered in the air dispersion models. The purpose is to decrease great uncertainties of setback determination using the mean or geometric mean of the data measured randomly during the daytime at any time of the year. Additionally, identification of the diurnal and seasonal odour and gas emission profiles can help to develop odour and gas abatement strategies targeting high odour and gas emission periods.
2. Long-term odour and gas measurements and appropriate repetition are needed to be able to obtain more reliable statistical analysis results since how accurate the statistical description depends partly on the size of the sample used. Moreover,

standardized air sampling protocols should be established to facilitate comparison of results from numerous experiments.

3. Odour and gas concentrations and emissions are affected by some other factors such as building characteristics, activity of the pigs, and levels of pen hygiene. Regarding the lack of precision of some models, animal activity and dirtiness of pens should be further investigated to improve prediction precisions of odour and gas statistical models. Furthermore, experiment measurements should be conducted again to validate those models.

## REFERENCES

Aarnink, A. J. A., A. Keen, J. H. M. Metz, L. Speelman and M. W. A. Verstegen. 1995. Ammonia emission patterns during the growing periods of pigs housed on partially slatted floors. *Journal of Agricultural Engineering Research* 62: 105-116.

Albright, L. D. 1990. Environment Control for Animal and Plants. St-Joseph, MI, USA: ASAE.

AMCA Standard 210, ASHRAE Standard 51. 1999. Laboratory methods of testing fans for aerodynamic performance rating. Arlington Heights, Illinois.

ASTM. 1991. E679-91. Standard practice for determination of odour and taste thresholds by a forced-choice ascending concentration series method of limits. In Annual Book of ASTM Standards.

Berckmans, D., J. Ni, J. Coenegrachts and E. Vranken. 1994. Influence of the control of ventilation rate on ammonia emission in a pig house. ASAE Paper No. 944589. Atlanta, Georgia, USA: ASAE.

Bicudo, J. R., D. R. Schmidt, S. W. Gay, R. S. Gates, L. D. Jacobson and S. J. Hoff. 2002. Air quality and emissions from livestock and poultry production waste management systems. *National Center for Manure and Animal Waste Management White Papers*, North Carolina State University, Raleigh, North Carolina, USA.

Bio-environmental and Structural Systems Lab. 2001. Fan test final report for Prairie Pride Enterprises. Department of Agricultural Engineering, University of Illinois, Illinois, USA.

CEN. 1999. Air Quality Determination of Odour Concentration by Dynamic Olfactometry. PrEN 13725. Brussels, Belgium: European Committee for Standardization.

Clanton, C.J., D.R. Schmidt, R.E. Nicolai, P.R. Goodrich, L.D. Jacobson, K.A. Janni, S. Weisberg and J.A. Buckel. 1999. Dynamic olfactometry variability in determining odour dilutions-to-threshold. *Transactions of the ASAE* Vol. 42 (4): 1103 – 1112.

Gay, S.W., D.R. Schmidt, C.J. Clanton, K.A. Janni, L.D. Jacobson and S. Weisberg. 2003. Odour, total reduced sulphur, and ammonia emissions from animal housing facilities and manure storage units in Minnesota. *Applied Engineering in Agriculture* Vol. 19(3): 347-360.

Groot Koerkamp, P.W.G., J.H.M. Metz, G.H. Uenk, V.R. Phillips, M.R. Holden, R.W. Sneath, J.L. Short, R.P. White, J. Hartung, J. Seedorf, M. Schroder, K.H. Linkert, S.

Pedersen, H. Takai, J.O. Johnsen and C.M. Wathes. 1998. Concentrations and emissions of ammonia in livestock buildings in northern Europe. *Journal of Agricultural Engineering Research* 70:79-95.

Guo, H., L. D. Jacobson, D. R. Schmidt, R. E. Nicolai and K.A. Janni. 2004. Comparison of five models for setback distance determination from livestock sites. *Canadian Biosystems Engineering* Vol. 46: 6.17-6.25.

Hartung, E. M., G. Brose and T. Jungbluth. 1998. Diurnal course of the odour release from livestock housings and the odour reduction of biofilters. *Proceedings of International Conference on Odour, Water Quality, Nutrient Management and Socioeconomic Issues*, 299-304, Convention Complex, Des Moines, Iowa, USA. July 19-22.

Hayes, E. T., T. P. Curran and V. A. Dodd. 2003. Odour and ammonia emissions from pig and poultry units. ASAE Paper No. 034082. Las Vegas, Nevada, USA: ASAE.

Heber, A. J., D.S. Bundy, T.T. Lim, J. Ni, B.L. Haymore, C. Diehl and R. Duggirala. 1998. Odour emission rates from swine finishing buildings. In *Animal Production Systems and the Environment. An International Conference on Odor, Water Quality, Nutrient Management and Socioeconomic Issues*. Vol. I. 305-310. Des Moines, Iowa, USA, July 20-22.

Jacobson, L.D., K. A. Janni and L. J. Johnston. 1998. Odour and gas reduction from sprinkling soybean oil in a pig nursery. In *ASAE Annual International Meeting*. Orlando, Florida, July 12-16. Paper No. 984125. St-Joseph, Michigan, USA: ASAE.

Jacobson, L. D., H. Guo, D.R. Schmidt and R.E. Nicolai. 2000. Calibrating an odour dispersion model by resident-panellists. *Proceedings of the Second International Conference on Air Pollution from Agricultural Operations*. Des Moines, Iowa, USA, October 9-11.

Janni, K., L. Jacobson, D. Schmidt, K. Norlien and T. Rosenstein. 2002. Livestock and poultry odour workshop proceedings. Department of Biosystems and Agricultural Engineering, University of Minnesota. St. Paul, MN, USA.

Kurvits, T. and T. Marta. 1998. Agricultural NH<sub>3</sub> and NO<sub>x</sub> emissions in Canada. *Environmental Pollution* 102 (supplement 1):187-194.

Lim, T. T., A.J. Heber and J. Ni. 2000. Odour setback guideline for swine production systems. *Proceedings of Odors and VOC Emissions 2000*. Cincinnati, Ohio, USA, April 16-19.

Lim, T. T., A. J. Heber, J. Ni, A. L. Sutton and D. T. Kelly. 2001. Characteristics and emission rates of odour from swine nursery buildings. *Transactions of the ASAE* Vol. 44(5):1275-1282.

Ni, J., A. J. Heber, T. T. Lim, C. A. Diehl, R. K. Duggirala, B. L. Haymore and A. L. Sutton. 2000a. Ammonia emission from a large mechanically ventilated swine building during warm weather. *Journal of Environmental Quality* 29(3):751-758.

Ni, J., A. J. Heber, C. A. Diehl and T. T. Lim. 2000b. Ammonia, hydrogen sulfide and carbon dioxide from pig manure in under-floor deep pits. *Journal of Agricultural Engineering Research* 77 (1):53-66.

Ni, J., A. J. Heber, T. T. Lim, C. A. Diehl, R. K. Duggirala and B. L. Haymore. 2002. Hydrogen sulfide emission from two large pig-finishing buildings with long-term high-frequency measurements. *Journal of Agricultural Science* 138 (2): 227-236.

Osada, T., H. B. Rom and P. Dahl. 1998. Continuous measurements of nitrous oxide and methane emission in pig units by infrared photo acoustic detection. *Transactions of the ASAE* Vol. 41 (4): 1109 – 1114.

Prairie Swine Center Inc. 2005. [http:// www.prairieswine.com/](http://www.prairieswine.com/) Accessed October 18, 2005. Saskatoon, SK, Canada.

SAS Institute Inc. 1999. SAS/STAT User's Guide, version 8. SAS Institute Inc., Cary, NC, USA.

Schauberger, G., and M. Piringer. 1997. Guideline to assess the protection distance to avoid annoyance by odour sensation caused by livestock husbandry. In *Proceedings of the Fifth International Livestock Environment Symposium*. St-Joseph, MI, USA.

Schauberger, G., M. Piringer and E. Petz. 1999. Diurnal and annual variation of odour emission from animal houses: a model calculation for fattening pigs. *Journal of Agricultural Engineering Research* 74: 251-259.

Schmidt, D. R., L.D. Jacobson and K.A. Janni. 2002. Continuous monitoring of ammonia, hydrogen sulfide and dust emissions from swine, dairy and poultry barns. ASAE Paper No.024060. Chicago, Illinois, USA: ASAE.

Smith, R. J. and P. A. Dalton. 1999. Factors affecting the rate of odour emissions from Australian piggery buildings. In *Proceedings of Australasian Environmental Engineering Conference*. Auckland, New Zealand, July 10-14.

Townend, J. 2002. Practical statistics for environmental and biological scientists. West sussex, England: John Wiley & Sons Ltd.

World Meteorological Organization. 2005. <http://www.worldweather.org/> Accessed October 21, 2005. The United Nations.



Zhou, X. and Q. Zhang. 2003. Measurement of odour and hydrogen sulfide emissions from swine barns. *Canadian Biosystems Engineering* Vol. 45: 6.13-6.18.

Zhu, J., L. Jacobson, S. Schmidt and R. Nicolai. 1999. Daily variations in odour and gas emissions from animal facilities. *Applied Engineering in Agriculture* Vol. 16(2): 153-158.

## APPENDIX A SWINE ENVIRONMENT MEASURING SYSTEM

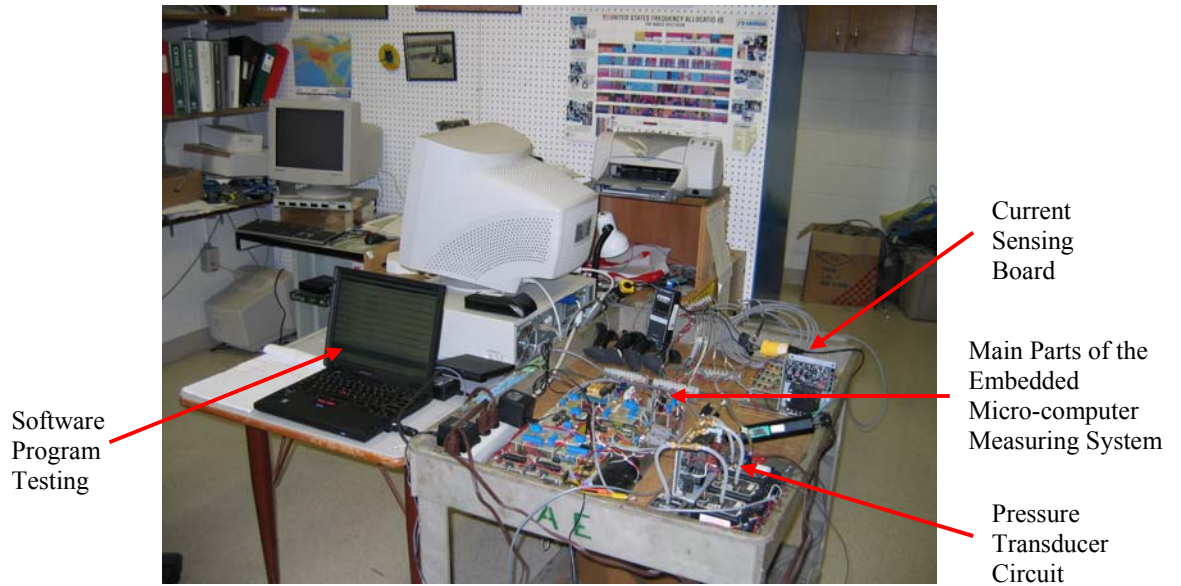

Figure A.1 The environment measuring system made and tested in the lab.



Figure A.2 The Measuring system installed in the swine barn.

## APPENDIX B CALIBRATION OF THE SENSORS

### B.1 Calibration of the Temperature Sensors



Figure B.1 The temperature sensors.



Figure B.2 Calibration of the temperature sensors using the angelantoni climatic system.

The temperature sensor (TC 1047, Microchip Technology Inc., Chandler, AZ, USA) is a linear voltage output sensor that can accurately measure temperature from  $-40^{\circ}\text{C}$  to  $125^{\circ}\text{C}$  with  $\pm 0.5^{\circ}\text{C}$  precision. The calibration results presenting the relationship between the output voltage of the sensor and the temperature are given in Table B.1.

Table B.1 The calibration results of the temperature sensors.

Temperature Sensor	Conversion Equation	$r^2$
Room 6 room T sensor	$V=104.81T-53.348$	0.9986
Room 6 outside T sensor	$V=99.556T-48.967$	0.9995
Room 9 room T sensor	$V=103.9T-52.592$	0.9982
Room 9 outside T sensor	$V=101.28T-49.903$	0.9992
Room 10 room T sensor	$V=101.83T-51.009$	0.9991
Room 10 outside T sensor	$V=101.85T-51.052$	0.9994
Room 11 room T sensor	$V=103.19T-51.855$	0.9991
Room 11 outside T sensor	$V=103.01T-51.902$	0.9993

Note: V is the output voltage of the sensors; T is the temperature ( $^{\circ}\text{C}$ ).

## B.2 Calibration of the Relative Humidity Sensors



Figure B.3 The relative humidity sensors covered with PVC covers.



Figure B.4 Calibration of the relative humidity sensors using the Hydro-MZ dew point monitor.

The relative humidity sensor (HIH-3160, Honeywell Inc., Freeport, Illinois, USA) is a laser trimmed thermo set polymer capacitive sensing element with on-chip integrated signal conditioning. The accuracy of the RH sensor is  $\pm 2\%$  ( $25^{\circ}\text{C}$ ,  $V_{\text{sup } ply} = 5 \text{ VDC}$ ). It is covered with PVC covers to filter dust and light out to protect the sensor. The calibration results presenting the relationship between the output voltage of the sensor and the relative humidity are given in Table B.2.

Table B.2 The calibration results of the relative humidity sensors.

Relative Humidity Sensor	Conversion Equation	$r^2$
Room 6 RH sensor	$V=32.653RH-28.555$	0.9987
Room 9 RH sensor	$V=32.381RH-29.809$	0.9992
Room 10 RH sensor	$V=32.587RH-28.982$	0.9982
Room 11 RH sensor	$V=32.541RH-29.161$	0.9991

Note: V is the output voltage of the sensors; RH is the relative humidity (%).



### B.3 Calibration of the Pressure Transducers



Figure B.5 The pressure transducers and calibration of the sensors using the OMEGA pressure meter and pump.

The pressure transducer (Model 264, Setra System Inc, Boxborough, MA, USA) with an accuracy of  $\pm 1\%$  full scale (0 -  $\pm 0.5$  in. W. C.) is shown in Figure B.5. The calibration results are given in Table B.3.

Table B.3 The calibration results of the pressure transducer.

Pressure Transducer	Calibration Equation	$r^2$
Room 6 P transducer	$V=0.0922P-0.0703$	0.9908
Room 9 P transducer	$V=0.2662P-0.6186$	1.0000
Room 10 P transducer	$V=0.2014P-0.4847$	0.9998
Room 11 P transducer	$V=0.1798P-0.5338$	0.9996

Note: V is the output voltage of the sensors; P is the pressure (inch water).

#### B.4 Calibration of the Hall Fan Sensors



Figure B.6 Calibration of the Hall fan sensors using the 50-MHz pulse generator and 1.3-GHz frequency counter.

The variable-speed fan RPM sensor is a micro switch Hall Effect position sensor (SR3F-A1, Honeywell Inc., Freeport, Illinois, USA). The calibration equation was  $V = 367.5F - 6.0451$  ( $V$  is the output voltage of the sensors;  $F$  is the frequency) with  $r^2 = 1$ .

## APPENDIX C VERIFICATION OF THE FAN AIR FLOW RATE

During the test, inlet opening was adjusted at four steps 100%, 50%, 25%, and 10% so the according differential pressure was 18.4 Pa, 23.4 Pa, 37.1 Pa, and 61.0 Pa, respectively. All the tested fans were running at 100% full speed.

Tables C.1 and C.2 give the average airflow rates obtained using the fan manufacturer data method and the field measuring method on three tested fans. Figure C.1 shows the average airflow rates on three variable-speed fans.

Table C.1 Airflow rates of the three tested fans using fan manufacturer data.

Air flow Rate (m <sup>3</sup> s <sup>-1</sup> ) -Fan Curve Method					Average
Inlet Opening Difference	Pressure	Fan a	Fan b	Fan c	
100%	18.4	2.38	2.57	2.60	2.52
50%	23.4	2.31	2.52	2.29	2.37
25%	37.1	2.09	2.31	2.08	2.16
10%	61.0	1.69	1.68	1.70	1.69

Note: The unit of the pressure is the Pascal.

Table C.2 Airflow rates of the three tested fans using field calibration data.

Air flow Rate (m <sup>3</sup> s <sup>-1</sup> ) - Field Measurement					Average
Inlet Opening Difference	Pressure	Fan a	Fan b	Fan c	
100%	18.4	2.28	2.47	2.53	2.43
50%	23.4	2.15	2.41	2.25	2.27
25%	37.1	2.12	2.34	2.12	2.19
10%	61.0	1.65	1.77	1.77	1.73

Note: The unit of the pressure is the Pascal.



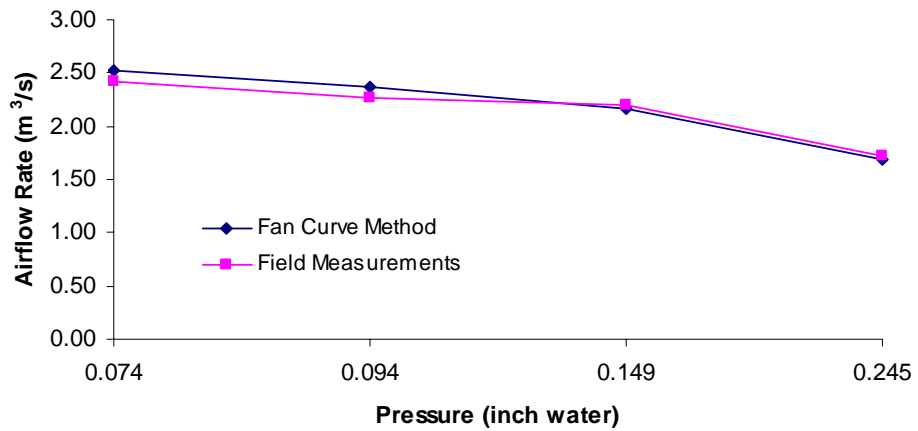

Figure C.1 Results of airflow rates on three variable-speed fans.

It can be concluded under this study that field fan performance was 4% lower than fan manufacturer data.

The airflow rates from single-speed fans are listed in Tables C.3 and C.4.

Table C.3 Airflow rates and environment parameters on single-speed fan-1.

Fan On/Off State	Single Speed Fan 1				
	Airflow (Fan Curve) m³/s	Airflow (Field) m³/s	T room ( C )	T outside ( C )	RH %
On	4.48	4.05	26.2	25.1	47.7

Table C.4 Airflow rates and environment parameters on single-speed fan-2.

Fan On/Off State	Single Speed Fan 2				
	Airflow (Fan Curve) m³/s	Airflow (Field) m³/s	T room ( C )	T outside ( C )	RH %
On	4.48	4.37	26.4	25.7	45.7

It can be concluded under this study that field fan performance was 6% less than fan manufacturer data on single-speed fans.

## APPENDIX D ODOUR AND GAS DATA STATISTICAL ANALYSIS

### D.1 Diurnal Odour and Gas Concentration and Emission Statistical Analysis

The statistical results from the SAS output for diurnal odour and gas concentrations and emissions are presented in Tables D.1 to D.24. In each ANOVA table, three important source parameters should be specially noted and analyzed. One is '*Flooring*' factor, another is '*Diurnal*' factor, and the third is the interaction of those two factors. The significance of the effects and interactions were determined at the 5% level.

If the *P*-value of '*Flooring*' factor was greater than 0.05, it indicated that there was no significant difference between the odour and gas concentrations and emissions from the two experimental rooms, and vice versa. If the *P*-value of '*Diurnal*' factor was less than 0.05, it suggested that the '*Diurnal*' effect (a function of ambient and room temperature, ventilation rate, the swine management, etc.) had a significant effect on odour and gas concentrations and emissions, i.e., significant diurnal variations of odour and gas concentrations and emissions were observed, and vice versa. If the *P*-value of '*Flooring*' \* '*Diurnal*' was greater than 0.05, it meant that there was no interaction between the '*Flooring*' factor and the '*Diurnal*' factor; hence the means of odour and gas concentrations or emissions from different rooms could be compared without considering their interaction terms.

### D.1.1 Statistical Analysis Results for Diurnal Odour and Gas Concentrations and Emissions in August

Table D.1 ANOVA table for odour concentration in August.

Source	DF	Sum of Square	Mean of Square	F Value	Pr>F
Day	1	13820	13820	1.13	0.48
Flooring	1	27554	27554	2.26	0.37
Day*Flooring	1	12207	12207	1.65	0.24
Diurnal	7	54951	7850	1.04	0.48
Day*Diurnal	7	52750	7536	1.02	0.49
Flooring*Diurnal	7	20582	2940	0.40	0.88
Error	7	51710	7387		
Corrected Total	31	233573			

Note: Analysis Model: Pr>F=0.53; R<sup>2</sup>=0.78.

Table D.2 ANOVA table for odour emission in August.

Source	DF	Sum of Square	Mean of Square	F Value	Pr>F
Day	1	5398	5398	4.11	0.29
Flooring	1	178	178	0.14	0.78
Day*Flooring	1	1313	1313	1.35	0.28
Diurnal	7	49317	7045	7.74	0.0075
Day*Diurnal	7	6375	911	0.94	0.53
Flooring*Diurnal	7	3537	505	0.52	0.80
Error	7	6810	973		
Corrected Total	31	72926			

Note: Analysis Model: Pr>F=0.08; R<sup>2</sup>=0.9.

Table D.3 ANOVA table for NH<sub>3</sub> concentration in August.

Source	DF	Sum of Square	Mean of Square	F Value	Pr>F
Day	1	1.76	1.76	1.00	0.50
Flooring	1	490.51	490.51	278.63	0.04
Day*Flooring	1	1.76	1.76	1.69	0.21
Diurnal	23	98.74	4.29	3.09	0.0046
Day*Diurnal	23	31.99	1.39	1.33	0.25
Flooring*Diurnal	23	22.24	0.97	0.93	0.57
Error	23	23.99	1.04		
Corrected Total	95	670.99			

Note: Analysis Model: Pr>F=0.0001; R<sup>2</sup>=0.96.

Table D.4 ANOVA table for H<sub>2</sub>S concentration in August.

Source	DF	Sum of Square	Mean of Square	F Value	Pr>F
Day	1	22419	22419	2.68	0.35
Flooring	1	21788	21788	2.61	0.35
Day*Flooring	1	8353	8353	4.93	0.06
Diurnal	7	68517	9788	4.09	0.04
Day*Diurnal	7	16761	2394	1.41	0.33
Flooring*Diurnal	7	20157	2880	1.70	0.25
Error	7	11858	1694		
Corrected Total	31	169853			

Note: Analysis Model: Pr>F=0.035; R<sup>2</sup>=0.93.

Table D.5 ANOVA table for CO<sub>2</sub> concentration in August.

Source	DF	Sum of Square	Mean of Square	F Value	Pr>F
Day	1	76501	76501	43.69	0.10
Flooring	1	29751	29751	16.99	0.15
Day*Flooring	1	1751	1751	0.91	0.35
Diurnal	23	1205011	52392	17.46	0.0001
Day*Diurnal	23	69011	3001	1.56	0.15
Flooring*Diurnal	23	147711	6422	3.34	0.003
Error	23	44161	1920		
Corrected Total	95	1573899			

Note: Analysis Model: Pr>F=0.0001; R<sup>2</sup>=0.97.

Table D.6 ANOVA table for NH<sub>3</sub> emission in August.

Source	DF	Sum of Square	Mean of Square	F Value	Pr>F
Day	1	4576	4576	3.68	0.31
Flooring	1	107575	107575	86.46	0.07
Day*Flooring	1	1244	1244	2.71	0.11
Diurnal	23	59571	2590	5.56	0.0001
Day*Diurnal	23	10718	466	1.02	0.49
Flooring*Diurnal	23	4115	179	0.39	0.99
Error	23	10555	459		
Corrected Total	95	198355			

Note: Analysis Model: Pr>F=0.0001; R<sup>2</sup>=0.96.

Table D.7 ANOVA table for H<sub>2</sub>S emission in August.

Source	DF	Sum of Square	Mean of Square	F Value	Pr>F
Day	1	13.26	13.26	1.79	0.41
Flooring	1	12.5	12.5	1.69	0.42
Day*Flooring	1	7.41	7.41	6.16	0.042
Diurnal	7	48.93	6.99	3.62	0.06
Day*Diurnal	7	13.5	1.93	1.6	0.27
Flooring*Diurnal	7	8.02	1.15	0.95	0.52
Error	7	8.42	1.2		
Corrected Total	31	112.04			

Note: Analysis Model: Pr>F=0.04; R<sup>2</sup>=0.92.

Table D.8 ANOVA table for CO<sub>2</sub> emission in August.

Source	DF	Sum of Square	Mean of Square	F Value	Pr>F
Day	1	17.94	17.94	595.93	0.03
Flooring	1	3.88	3.88	128.89	0.06
Day*Flooring	1	0.03	0.03	0.00	0.95
Diurnal	23	1682.78	73.16	5.49	0.0001
Day*Diurnal	23	306.79	13.34	2.02	0.049
Flooring*Diurnal	23	186.28	8.10	1.23	0.31
Error	23	151.86	6.60		
Corrected Total	95	2349.56			

Note: Analysis Model: Pr>F=0.0001; R<sup>2</sup>=0.94.

### D.1.2 Statistical Analysis Results for Diurnal Odour and Gas Concentrations and Emissions in October

Table D.9 ANOVA table for odour concentration in October.

Source	DF	Sum of Square	Mean of Square	F Value	Pr>F
Day	1	2438736	2438736	5.37	0.26
Flooring	1	1098162	1098162	2.42	0.36
Day*Flooring	1	454105	454105	5.17	0.06
Diurnal	7	728317	104045	0.43	0.86
Day*Diurnal	7	1713469	244781	2.79	0.10
Flooring*Diurnal	7	657854	93979	1.07	0.47
Error	7	614714	87816		
Corrected Total	31	7705357			

Note: Analysis Model: Pr>F=0.05; R<sup>2</sup>=0.92.

Table D.10 ANOVA table for odour emission in October.

Source	DF	Sum of Square	Mean of Square	F Value	Pr>F
Day	1	17340	17340	11.88	0.18
Flooring	1	14574	14574	9.99	0.20
Day*Flooring	1	1459	1459	2.04	0.20
Diurnal	7	2673	382	0.74	0.65
Day*Diurnal	7	3618	517	0.72	0.66
Flooring*Diurnal	7	1284	184	0.26	0.95
Error	7	5001	714		
Corrected Total	31	45949			

Note: Analysis Model: Pr>F=0.12; R<sup>2</sup>=0.89.

Table D.11 ANOVA table for NH<sub>3</sub> concentration in October.

Source	DF	Sum of Square	Mean of Square	F Value	Pr>F
Day	1	0.09	0.09	9.00	0.20
Flooring	1	3396.26	3396.26	100000	0.0001
Day*Flooring	1	0.01	0.01	0.01	0.92
Diurnal	23	148.74	6.47	0.86	0.64
Day*Diurnal	23	172.66	7.51	7.94	0.0001
Flooring*Diurnal	23	338.49	14.72	15.57	0.0001
Error	23	21.74	0.95		
Corrected Total	95	4077.99			

Note: Analysis Model: Pr>F=0.0001; R<sup>2</sup>=0.99.

Table D.12 ANOVA table for H<sub>2</sub>S concentration in October.

Source	DF	Sum of Square	Mean of Square	F Value	Pr>F
Day	1	3445	3445	6.33	0.24
Flooring	1	101025	101025	185.54	0.047
Day*Flooring	1	545	545	0.33	0.59
Diurnal	7	11686	1669	2.01	0.19
Day*Diurnal	7	5803	829	0.50	0.81
Flooring*Diurnal	7	5671	810	0.49	0.82
Error	7	11633	1662		
Corrected Total	31	139808			

Note: Analysis Model: Pr>F=0.0582; R<sup>2</sup>=0.92.

Table D.13 ANOVA table for CO<sub>2</sub> concentration in October.

Source	DF	Sum of Square	Mean of Square	F Value	Pr>F
Day	1	12353	12353	0.26	0.70
Flooring	1	1679840	1679840	35.58	0.11
Day*Flooring	1	47215	47215	5.71	0.03
Diurnal	23	3813334	165797	0.69	0.81
Day*Diurnal	23	5553707	241466	29.21	0.0001
Flooring*Diurnal	23	206441	8976	1.09	0.42
Error	23	190120	8266		
Corrected Total	95	11503010			

Note: Analysis Model: Pr>F=0.0001; R<sup>2</sup>=0.98.

Table D.14 ANOVA table for NH<sub>3</sub> emission in October.

Source	DF	Sum of Square	Mean of Square	F Value	Pr>F
Day	1	533	533	0.89	0.52
Flooring	1	97244	97244	162.62	0.05
Day*Flooring	1	598	598	5.37	0.03
Diurnal	23	11926	518	6.98	0.0001
Day*Diurnal	23	1708	74	0.67	0.83
Flooring*Diurnal	23	3674	160	1.43	0.20
Error	23	2561	111		
Corrected Total	95	118242			

Note: Analysis Model: Pr>F=0.0001; R<sup>2</sup>=0.98.

Table D.15 ANOVA table for H<sub>2</sub>S emission in October.

Source	DF	Sum of Square	Mean of Square	F Value	Pr>F
Day	1	0.0003	0.0003	0.04	0.87
Flooring	1	12.63	12.63	1616.04	0.02
Day*Flooring	1	0.01	0.01	0.04	0.85
Diurnal	7	4.81	0.69	7.08	0.01
Day*Diurnal	7	0.68	0.10	0.49	0.82
Flooring*Diurnal	7	0.73	0.10	0.52	0.79
Error	7	1.39	0.20		
Corrected Total	31	20.25			

Note: Analysis Model: Pr>F=0.0338; R<sup>2</sup>=0.93.

Table D.16 ANOVA table for CO<sub>2</sub> emission in October.

Source	DF	Sum of Square	Mean of Square	F Value	Pr>F
Day	1	33	33	0.19	0.74
Flooring	1	1588	1588	9.33	0.20
Day*Flooring	1	170	170	25.26	0.0001
Diurnal	23	626	27	2.42	0.02
Day*Diurnal	23	259	11	1.67	0.11
Flooring*Diurnal	23	105	5	0.68	0.82
Error	23	155	7		
Corrected Total	95	2936			

Note: Analysis Model: Pr>F=0.0001; R<sup>2</sup>=0.95.

### D.1.3 Statistical Analysis Results for Diurnal Odour and Gas Concentrations and Emissions in February

Table D.17 ANOVA table for odour concentration in February.

Source	DF	Sum of Square	Mean of Square	F Value	Pr>F
Day	1	1129129	1129129	192.72	0.046
Flooring	1	17153689	17153689	2927.73	0.01
Day*Flooring	1	5859	5859	0.01	0.94
Diurnal	7	2684068	383438	0.40	0.87
Day*Diurnal	7	6657243	951035	0.91	0.55
Flooring*Diurnal	7	7255274	1036468	1.00	0.50
Error	7	728679	1040897		
Corrected Total	31	42171542			

Note: Analysis Model: Pr>F=0.34; R<sup>2</sup>=0.83

Table D.18 ANOVA table for odour emission in February.

Source	DF	Sum of Square	Mean of Square	F Value	Pr>F
Day	1	264	264	3.34	0.32
Flooring	1	30387	30387	384.33	0.03
Day*Flooring	1	79	79	0.05	0.84
Diurnal	7	5300	757	0.37	0.90
Day*Diurnal	7	14433	2062	1.19	0.41
Flooring*Diurnal	7	15167	2167	1.25	0.39
Error	7	12179	1740		
Corrected Total	31	77811			

Note: Analysis Model: Pr>F=0.28; R<sup>2</sup>=0.84.



Table D.19 ANOVA table for NH<sub>3</sub> concentration in February.

Source	DF	Sum of Square	Mean of Square	F Value	Pr>F
Day	1	59	59	0.82	0.53
Flooring	1	334	334	4.65	0.28
Day*Flooring	1	72	72	29.22	0.0001
Diurnal	23	545	24	1.64	0.12
Day*Diurnal	23	339	15	6.00	0.0001
Flooring*Diurnal	23	139	6	2.47	0.0174
Error	23	56	2		
Corrected Total	95	1553			

Note: Analysis Model: Pr>F=0.0001; R<sup>2</sup>=0.96.

Table D.20 ANOVA table for H<sub>2</sub>S concentrations in February.

Source	DF	Sum of Square	Mean of Square	F Value	Pr>F
Day	1	1739113	1739113	143.85	0.05
Flooring	1	75855	75855	6.27	0.24
Day*Flooring	1	12090	12090	0.93	0.37
Diurnal	7	49149	7021	0.60	0.74
Day*Diurnal	7	81407	11630	0.89	0.56
Flooring*Diurnal	7	108930	15561	1.19	0.41
Error	7	91265	13038		
Corrected Total	31	2157808			

Note: Analysis Model: Pr>F=0.0078; R<sup>2</sup>=0.96.

Table D.21 ANOVA table for CO<sub>2</sub> concentrations in February.

Source	DF	Sum of Square	Mean of Square	F Value	Pr>F
Day	1	73132959	73132959	894.23	0.02
Flooring	1	3365257	3365257	41.15	0.10
Day*Flooring	1	81783	81783	3.21	0.09
Diurnal	23	38313265	1665794	11.15	0.0001
Day*Diurnal	23	3435868	149386	5.87	0.0001
Flooring*Diurnal	23	538211	23401	0.92	0.58
Error	23	585148	25441		
Corrected Total	95	119452493			

Note: Analysis Model: Pr>F=0.0001; R<sup>2</sup>=0.995.

Table D.22 ANOVA table for NH<sub>3</sub> emission in February.

Source	DF	Sum of Square	Mean of Square	F Value	Pr>F
Day	1	169	169	1.06	0.49
Flooring	1	631	631	3.97	0.30
Day*Flooring	1	159	159	2.13	0.16
Diurnal	23	3875	168	1.33	0.25
Day*Diurnal	23	2923	127	1.70	0.10
Flooring*Diurnal	23	2539	110	1.48	0.18
Error	23	1715	75		
Corrected Total	95	12009			

Note: Analysis Model: Pr>F=0.041; R<sup>2</sup>=0.86.

Table D.23 ANOVA table for H<sub>2</sub>S emissions in February.

Source	DF	Sum of Square	Mean of Square	F Value	Pr>F
Day	1	58.16	58.16	48.41	0.09
Flooring	1	1.19	1.19	0.99	0.50
Day*Flooring	1	1.20	1.20	3.55	0.10
Diurnal	7	1.43	0.20	1.05	0.47
Day*Diurnal	7	1.36	0.19	0.58	0.76
Flooring*Diurnal	7	2.43	0.35	1.03	0.49
Error	7	2.37	0.34		
Corrected Total	31	68.14			

Note: Analysis Model: Pr>F=0.004; R<sup>2</sup>=0.97.

Table D.24 ANOVA table for CO<sub>2</sub> emissions in February.

Source	DF	Sum of Square	Mean of Square	F Value	Pr>F
Day	1	2719	2719	131.81	0.06
Flooring	1	28	28	1.36	0.45
Day*Flooring	1	21	21	2.61	0.12
Diurnal	23	3070	133	9.76	0.0001
Day*Diurnal	23	315	14	1.73	0.10
Flooring*Diurnal	23	259	11	1.43	0.20
Error	23	182	8		
Corrected Total	95	6593			

Note: Analysis Model: Pr>F=0.0001; R<sup>2</sup>=0.97.

#### D.1.4 Summary of Means (S.D.) of Diurnal Measured Variables

Table D.25 Summary of means and standard deviations (S.D.) of diurnal measured variables during three measurement seasons.

Variables	Month	Room 9	Room 10
Odour concentration (OU m <sup>-3</sup> )	August	406 (77)	464 (87)
	October	1053 (77)	1345 (603)
	February	1683 (515)	3040 (1184)
Odour emission rate (OU AU <sup>-1</sup> s <sup>-1</sup> )	August	122.2 (47.7)	126.7 (50.8)
	October	62.2 (23.1)	101.7 (39.5)
	February	77.1 (24.4)	134.5 (50.7)
Odour emission rate (OU m <sup>-2</sup> s <sup>-1</sup> )	August	18.1 (7.1)	19.5 (7.8)
	October	7.6 (3.5)	12.3 (5.5)
	February	10.8 (3.4)	19.2 (7.2)
NH <sub>3</sub> concentration (ppm)	August	5 (1)	9 (2)
	October	11 (2)	22 (3)
	February	27 (3)	32 (4)
NH <sub>3</sub> emission rate (g AU <sup>-1</sup> d <sup>-1</sup> )	August	86.9 (27.5)	154.7 (33.9)
	October	40.5 (15.3)	103.2 (14.5)
	February	81.4 (13.8)	87.2 (8.4)
NH <sub>3</sub> emission rate (g m <sup>-2</sup> d <sup>-1</sup> )	August	12.9 (4.1)	23.8 (5.2)
	October	5.0 (2.1)	12.5 (1.9)
	February	11.4 (1.9)	12.4 (1.2)
H <sub>2</sub> S concentration (ppm)	August	0.106 (0.037)	0.158 (0.092)
	October	0.090 (0.034)	0.201 (0.037)
	February	0.229 (0.228)	0.315 (0.328)
H <sub>2</sub> S emission rate (g AU <sup>-1</sup> d <sup>-1</sup> )	August	3.9 (1.3)	5.1 (2.2)
	October	0.67 (0.34)	1.92 (0.63)
	February	1.20 (0.18)	1.63 (1.70)
H <sub>2</sub> S emission rate (g m <sup>-2</sup> d <sup>-1</sup> )	August	0.6 (0.2)	0.8 (0.3)
	October	0.08 (0.04)	0.23 (0.08)
	February	0.17 (1.27)	0.23 (0.24)
CO <sub>2</sub> concentration (ppm)	August	508 (156)	544 (90)
	October	1966 (309)	2225 (335)
	February	3647 (1126)	4030 (1220)
CO <sub>2</sub> emission rate (kg AU <sup>-1</sup> d <sup>-1</sup> )	August	23.0 (4.7)	23.6 (5.2)
	October	18.5 (3.3)	26.5 (4.1)
	February	26.5 (9.0)	27.8 (8.0)
CO <sub>2</sub> emission rate (kg m <sup>-2</sup> d <sup>-1</sup> )	August	3.4 (0.7)	3.6 (0.8)
	October	2.3 (0.5)	3.2 (0.5)
	February	3.7 (1.3)	4.0 (1.1)
Ventilation rate (m <sup>3</sup> s <sup>-1</sup> )	August	11.7 (3.4)	11.0 (2.9)
	October	1.9 (0.7)	2.4 (0.6)
	February	1.6 (0.3)	1.6 (0.2)
Animal units (AU)	August	37	38.5
	October	27.7; 33.3*	28.6; 32.2*
	February	35	35.7

Note: means of odour concentrations and emissions are all geometric means.

## D.2 Seasonal Odour and Gas Concentration and Emission Statistical Analysis

The statistical results from the SAS output for seasonal odour and gas concentrations and emissions are given in Tables D.26 to D.33. In each ANOVA table, three important source parameters should be specially noted and analyzed. The first is the interaction of the two factors: '*Flooring*' and '*Month*' factors. The other two are the '*Flooring*' factor and the '*Month*' factor. The significances of the effects were determined at the 5% level.

The SAS output analysis process had two steps. The first step was to examine whether the interaction of '*flooring*' and '*month*' factors was significant or not. If the *P*-value of the interaction was greater than 0.05, which indicated the relative performance of flooring system did not differ over the sampling months, then the next step was to conduct the means comparison of the four rooms' seasonal odour and gas concentrations and emissions in time analysis. If the *P*-value of the interaction was less than 0.05, which indicated the relative performance of flooring system differed significantly over the sampling months, then the next step was to analyze the effect of '*flooring*' factor on odour and gas concentrations and emissions under each month level.

Table D.26 ANOVA table for seasonal odour concentrations in four pig rooms.

Source	DF	Sum of Square	Mean of Square	F Value	Pr>F
Flooring*Month					0.23
Room	1	617859	617859	2.93	0.34
Flooring	1	7523219	7523219	35.63	0.11
Room*Flooring	1	211143	211143	0.70	0.42
Month	10	37615014	3761501	6.89	0.0026
Room*Month	10	5456463	545646	1.82	0.18
Flooring*Month	10	4872398	487240	1.62	0.23
Error	10	3006145	300614		
Corrected Total	43	59302241			

Note: Analysis Model: Pr>F=0.031; R<sup>2</sup>=0.95.

Table D.27 ANOVA table for seasonal odour emissions in four pig rooms.

Source	DF	Sum of Square	Mean of Square	F Value	Pr>F
Flooring*Month					0.57
Room	1	4711	4711	1.60	0.43
Flooring	1	20645	20645	7.02	0.23
Room*Flooring	1	2941	2941	0.97	0.35
Month	10	104739	10474	7.62	0.002
Room*Month	10	13749	1375	0.45	0.89
Flooring*Month	10	27010	2701	0.89	0.57
Error	10	30273	3027		
Corrected Total	43	204067			

Note: Analysis Model: Pr>F=0.18; R<sup>2</sup>=0.85.

Table D.28 ANOVA table for seasonal NH<sub>3</sub> concentrations in four pig rooms.

Source	DF	Sum of Square	Mean of Square	F Value	Pr>F
Flooring*Month					0.03
Flooring (August)	1	6.25	6.25	25.00	0.13
Flooring (September)	1	12.25	12.25	49.00	0.09
Flooring (October)	1	225.00	225.00	225.00	0.04
Flooring (November)	1	9.00	9.00	99999.99	0.0001
Flooring (December)	1	144.00	144.00	4.00	0.30
Flooring (January)	1	272.25	272.25	1089.00	0.02
Flooring (February)	1	6.25	6.25	1.00	0.50
Flooring (March)	1	0.25	0.25	0.01	0.94
Flooring (April)	1	36.00	36.00	9.00	0.20
Flooring (May)	1	30.25	30.25	13.44	0.17
Flooring (July)	1	16.00	16.00	4.00	0.30

Table D.29 ANOVA table for seasonal NH<sub>3</sub> emissions in four pig rooms.

Source	DF	Sum of Square	Mean of Square	F Value	Pr>F
Flooring*Month					0.30
Room	1	8	8	0.00	0.96
Flooring	1	13124	13124	6.31	0.24
Room*Flooring	1	2080	2080	2.59	0.14
Month	10	27819	2782	3.72	0.03
Room*Month	10	7487	749	0.93	0.54
Flooring*Month	10	11312	1131	1.41	0.30
Error	10	8027	803		
Corrected Total	43	69855			

Note: Analysis Model: Pr>F=0.078; R<sup>2</sup>=0.89.

Table D.30 ANOVA table for seasonal H<sub>2</sub>S concentrations in four pig rooms.

Source	DF	Sum of Square	Mean of Square	F Value	Pr>F
Flooring*Month					0.04
Flooring (August)	1	0.00065	0.00065	104.04	0.06
Flooring (September)	1	0.0012	0.0012	28.17	0.12
Flooring (October)	1	0.05	0.05	17.96	0.15
Flooring (November)	1	0.00000025	0.00000025	0.01	0.93
Flooring (December)	1	0.00004	0.00004	2.09	0.39
Flooring (January)	1	0.000004	0.000004	4.00	0.30
Flooring (February)	1	0.0000023	0.0000023	1.00	0.50
Flooring (March)	1	0.0006	0.0006	0.03	0.89
Flooring (April)	1	0.003	0.003	1.00	0.50
Flooring (May)	1	0.00002	0.00002	3.24	0.32
Flooring (July)	1	0.00046	0.00046	4.19	0.29

Table D.31 ANOVA table for seasonal H<sub>2</sub>S emissions in four pig rooms.

Source	DF	Sum of Square	Mean of Square	F Value	Pr>F
Flooring*Month					0.19
Room	1	1.84	1.84	1.27	0.46
Flooring	1	0.02	0.02	0.02	0.92
Room*Flooring	1	1.45	1.45	3.61	0.09
Month	10	142.93	14.29	27.60	0.0001
Room*Month	10	5.18	0.52	1.29	0.35
Flooring*Month	10	7.09	0.71	1.76	0.19
Error	10	4.03	0.40		
Corrected Total	43	162.54			

\* Analysis Model: Pr>F=0.0001; R<sup>2</sup>=0.98.

Table D.32 ANOVA table for seasonal CO<sub>2</sub> concentrations in four pig rooms.

Source	DF	Sum of Square	Mean of Square	F Value	Pr>F
Flooring*Month					0.0001
Flooring (August)	1	7225	7225	289.00	0.04
Flooring (September)	1	1225	1225	0.29	0.69
Flooring (October)	1	10000	10000	0.20	0.73
Flooring (November)	1	44100	44100	2.61	0.35
Flooring (December)	1	900	900	4.00	0.30
Flooring (January)	1	60025	60025	4.96	0.27
Flooring (February)	1	211600	211600	44.44	0.09
Flooring (March)	1	113906	113906	1.53	0.43
Flooring (April)	1	1670556	1670556	35.31	0.11
Flooring (May)	1	10000	10000	0.59	0.58
Flooring (July)	1	6806	6806	0.49	0.61

Table D.33 ANOVA table for seasonal CO<sub>2</sub> emissions in four pig rooms.

Source	DF	Sum of Square	Mean of Square	F Value	Pr>F
Flooring*Month					0.02
Flooring (August)	1	59.29	59.29	1.28	0.46
Flooring (September)	1	1.96	1.96	4.00	0.30
Flooring (October)	1	2.56	2.56	0.10	0.80
Flooring (November)	1	0.64	0.64	64.00	0.08
Flooring (December)	1	22.56	22.56	1002.78	0.02
Flooring (January)	1	287.30	287.30	35.37	0.11
Flooring (February)	1	0.16	0.16	0.25	0.70
Flooring (March)	1	1.69	1.69	0.04	0.87
Flooring (April)	1	68.06	68.06	7.32	0.23
Flooring (May)	1	1.96	1.96	0.11	0.80
Flooring (July)	1	15.60	15.60	7.42	0.22