

Quetiapine modulates anxiety-like behaviours and alleviates the decrease of BDNF in the amygdala of an APP/PS1 transgenic mouse model of Alzheimer's disease

A Thesis Submitted to the
College of Graduate Studies and Research
in Partial Fulfillment of the Requirements
for a Master's Degree
in the Department of Psychiatry
University of Saskatchewan
Saskatoon

By

Adrien Paul Nicholas Tempier

PERMISSION TO USE

In presenting this thesis in partial fulfillment of the requirements for a Master's degree from the University of Saskatchewan, I agree that the Libraries of this University may make it freely available for inspection. I further agree that permission for copying of this thesis in any manner, in whole or in part, for scholarly purposes may be granted by Dr. X.-M. Li, who supervised my thesis work, or in his absence, by the Head of the Department of Psychiatry, at the University of Saskatchewan. It is understood that any copying, publication, or use of this thesis or parts thereof for financial gain shall not be allowed without my written permission.

It is also understood that due recognition shall be given to me, to the Neuropsychiatry Research Unit of the Department of Psychiatry and to the University of Saskatchewan in any scholarly use which may be made of any material in my thesis.

Requests for permission to copy or to make other use of material in this thesis in whole or part should be addressed to:

Head of the Department of Psychiatry
University of Saskatchewan
Saskatoon, Saskatchewan
Canada, S7N 5E4

ABSTRACT

Quetiapine, an atypical antipsychotic drug, is effective in treating the behavioural and the psychological symptoms of dementia (BPSD). The objective of this study was to examine the effects of quetiapine on anxiety-like behaviour in the amyloid precursor protein (APP)/presenilin 1 (PS1) double transgenic mouse model of Alzheimer's disease (AD). The mice were treated with quetiapine (0, 2.5, or 5 mg/kg/day) orally in drinking water for 7 or 10 months starting from 2 months of age. Conditioned anxiety was measured using the elevated T-maze (ETM). To measure memory, the Y-maze and the Morris Water maze were employed. After behavioural testing, β -amyloid ($A\beta$) plaques in the hippocampus and cortex of transgenic mice were stained using Congo Red. Brain-derived neurotrophic factor (BDNF) in the basolateral amygdala (BLA) and the hippocampus of mice was examined using immunohistochemical methods. The statistics revealed an interaction between quetiapine and APP/PS1 double transgenic mice in the avoidance phase of the ETM. Quetiapine modulates anxiety-like behaviours in the ETM. The anxiety-like behaviours were associated with reductions in BDNF levels in the BLA and hippocampus of the transgenic mice. This was reversed by treatment with quetiapine. Furthermore, chronic administration of quetiapine attenuated the memory impairment and decreased the $A\beta$ plaque load in the brain. This study demonstrates that quetiapine normalizes anxiety-like behaviour and up-regulates cerebral BDNF levels in the APP/PS1 mice, suggesting that quetiapine may function as a neuroprotectant as well as an antipsychotic in treating the BPSD associated with AD.

DEDICATION

This thesis is dedicated to my dear grandparents, Rene and John. Grandma, you are the reason that I take this project personal. Grandpa, with your constant rising to battle with grandma every day, I learned to perceive alzheimer's from a different angle than a purely memory based condition. Realizing that along with the deep love you share with grandma, managing her anxiety and behaviour changes truly can help improve one's quality of life. This dedication represents the undercurrent that propelled this thesis along.

ACKNOWLEDGEMENTS

I extend my gratitude to Dr. Xin-Min Li and Dr. J. Steven Richardson. Their supervision, ongoing encouragement and unwavering support—personal and professional—throughout the evolution of this process have strengthened my passion and commitment in research. Dr. Li's high standard for excellence has also challenged my research potential as a Master's student in the Neuropsychiatric Research Unit. He created an experience that not only improved my knowledge of neuroscience and the techniques associated with its study but also expressed his belief in me by offering me the opportunity to independently develop my ideas on this thesis project and by enabling me to participate in International and Local conferences. Dr. Richardson's open-door policy, patience, expertise in pharmacology and certainly his keen ear to my ideas in drug treatment were inspiring. For this, I am most grateful. Thank you. I thank Dr. Darrell D. Mousseau for his guidance and belief in my study. I am also thankful to my external examiner, Dr. Phyllis G. Paterson, for her guidance and particularly for her perceptive feedback on many aspects of this thesis.

Throughout my training as a Master's student, I have been most fortunate to work with colleagues who not only embraced my ideas and helped with my advancement in neurobiological research in psychiatry in countless ways but also shared a memorable friendship with me. Therefore, I express special thanks to Dr. Jue He, for his exceptional mentorship. Dr. He's humble demeanour and expertise motivated me to excel at experimental techniques for cognitive and behaviour testing as well as protein analysis—all essential areas for the success of this thesis. He was always patient with my independent developments of this thesis project, yet offered me critical feedback when necessary. Without his expertise this project would not have become an epic undertaking.

I also thank my colleagues and friends in the lab, namely Dr. Yanbo Zhang for his thought-provoking discussions and invaluable input into the development of my thesis. I thank Dr. Bin Yan for supporting my endeavours and for her wonderful friendship, and I thank my fellow graduate students, Yanlin Wang and Shenghua Zhu, whose unconditional support and challenging conversations have also strengthened my convictions in neuropsychiatric research. Thank you. The other students and post-doctoral fellows at the NRU, I also thank. They all contributed to making the NRU a stimulating and a pleasant place to work.

I would like to offer a special thank-you to Mrs. Gabriel Stegeman for her wonderful technical assistance. She taught me a long list of procedures; To Mr. Rene Mag-atas for his knowledge and wisemanship; To Dr. Jennifer Chlan-Fourney for her assistance with the microscope; To Monica Novotny for her assistance with the statistical analysis and interpretation of the results.

I would also like to thank the mice in this study, as well as all research animals in general for their contribution. Without their valuable existence our advancement in knowledge of and treatment in the medical sciences would not be this far.

I would lastly like to thank my fiancée for her unending love and support as well as edits. My parents, brother and sister, grandparents, rest of family and friends: they never questioned my ambitions-just always expressed their love and support. Their unconditional support was critical to my success.

These experiences have allowed me to improve as a person and have created new prospects for my future. For all of this, I am most grateful.

Part of this thesis was supported by an Alfred E. Molstad Trust graduate award from the Department of Psychiatry, University of Saskatchewan.

TABLE OF CONTENTS

PERMISSION TO USE.....	i
ABSTRACT.....	ii
DEDICATION	iii
ACKNOWLEDGEMENTS	iv
TABLE OF CONTENTS.....	vi
LIST OF TABLES	viii
LIST OF FIGURES.....	ix
LIST OF ABBREVIATIONS	xi
CHAPTER 1: INTRODUCTION	1
1.1 Neurobiological/Neuropsychological Basis of Alzheimer’s Disease: Amyloid Cascade Hypothesis 4	
1.2 Potential Factors Involved in Anxiety and Alzheimer’s Disease	5
1.2.1 Anxiety.....	6
1.2.2 <i>Clinical Anxiety in Alzheimer’s Disease</i>	7
1.2.3 <i>Cognition and Anxiety</i>	8
1.3 The Neurobiological/Neuropsychological Basis of Anxiety.....	9
1.3.1 <i>Anxiety Circuit</i>	9
1.3.2 <i>Amygdala</i>	9
1.3.3 <i>Hippocampus</i>	12
1.3.4 <i>Serotonin</i>	15
1.3.5 <i>Avoidance and Escape</i>	17
1.4 APP/PS1 Transgenic Mouse Model of Alzheimer’s Disease.....	18
1.4.1 <i>Relevance of Transgenic Mouse Studies to Clinical Trials</i>	18
1.4.2 <i>Anxiety-Like Behaviour in APP/PS1</i>	20
1.5 Behavioural Testing: The Elevated T Maze.....	21
1.5.1 <i>Overview of the Elevated T-Maze (ETM)</i>	21
1.5.2 <i>Pharmacological Studies Using the ETM</i>	23
1.5.3 <i>Neuronal Connectivity and Anxiety</i>	25
1.6 Quetiapine’s Effect in Alzheimer’s Disease.....	26
1.6.1 <i>Atypical Antipsychotics</i>	26
1.6.2 <i>Neuroprotective Properties of Quetiapine and Other Atypical Antipsychotics</i>	28
1.6.3 <i>Neurogenesis, Atypical Antipsychotics and Alzheimer’s disease</i>	30

1.6.4 Atypical Antipsychotics Including Quetiapine: Effects in Alzheimer’s Disease and the APP/PS1 Transgenic Mouse Model.....	31
CHAPTER 2: METHODOLOGY.....	34
2.1. Experimental Design.....	34
2.1.1 General Hypothesis.....	34
2.1.2 Study Design Analysis.....	34
2.1.4 Animals.....	35
2.1.3 Drug Treatment.....	38
2.2. Behavioural Testing.....	38
2.2.1 Anxiety: Elevated T-Maze.....	38
2.2.2 Y-Maze Test.....	42
2.2.3 Water Maze Test.....	42
2.3 Tissue Processing and Histology.....	43
2.3.1 BDNF Level Measurements.....	43
2.3.2 Staining and Quantification of Amyloid Deposits.....	44
2.4 Statistical Analysis.....	45
CHAPTER 3: RESULTS.....	46
3.1. Conditioned Anxiety and Unconditioned Anxiety in the ETM.....	46
3.1.1. Avoidance.....	46
3.1.2. Escape.....	46
3.2. BDNF Levels in the Basolateral Amygdala and the Hippocampus.....	47
3.2.1. Basolateral Amygdala.....	47
3.2.2. Hippocampus.....	47
3.3. β -Amyloid Plaque Formation in APP/PS1 Mice Treated With Quetiapine.....	56
3.4. Y-Maze Spatial Working Memory in APP/PS1 Mice Compared With Control.....	56
CHAPTER 4: DISCUSSION.....	64
4.1 Report of A β plaque load and memory impairment.....	65
4.2. Phenotype of Conditioned Anxiety and Unconditioned Anxiety in the ETM.....	66
4.3. Chronic Administration of Quetiapine: Effect on Conditioned Anxiety.....	67
4.4. Role of BDNF in BLA and Hippocampus.....	67
4. 5. General Discussion and Implications of Future Research.....	69

LIST OF TABLES

Table 1. Number of Mice in Each Group.....37

LIST OF FIGURES

Figure 1. Diagram of the signal cascades linking the initial physiological events by which fear conditioning modulates the expression of BDNF in the lateral amygdala (LA).	14
Figure 1. PCR photographic representation of complementary DNA obtained from double transgenic APP/PS1 mouse carrier and single transgenic PS1 or APP mice carriers.....	36
Figure 3. Schematic representation of the elevated T-maze (ETM).....	40
Figure 4. Model of the elevated T-maze (ETM) behavioural procedure.	41
Figure 5. Avoidance in the elevated T-maze in female mice.	48
Figure 6. Escape in the elevated T-maze in female mice.....	49
Figure 7. Representative photomicrograph of BDNF immunostaining in the amygdala of a 12 month old female mice treated with quetiapine for 10 months.....	50
Figure 8. Quantitative analysis of BDNF-positive cells in the BLA (Basolateral Amygdala) of 12-month old female mice.	51
Figure 9. Representative photomicrographs of BDNF immunostaining in the BLA (Basolateral amygdala) in 12-month old female mice.	52
Figure 10. Representative photomicrograph of BDNF immunostaining in the hippocampus of a 12-month old female mice treated with quetiapine for 10 months.	53
Figure 11. Quantitative analysis of BDNF-positive cells in the Hippocampus (CA1, CA2, CA3, DG) of 12-month old female mice.	54
Figure 12. Representative photomicrographs of BDNF immunostaining in CA1 pyramidal cell layers of the hippocampus in 12-month old female mice.....	55
Figure 13. Representative photomicrographs of Congo Red staining showing A β plaques in the cortex and hippocampus of 9-month of age APP/PS1 mice.	58
Figure 14. Quantitative analysis of plaques by Congo Red staining in the cortex and hippocampus.	59
Figure 15. Representative photomicrographs of Congo Red staining showing A β plaques in the hippocampus and BLA of 12-month of age APP/PS1 mice.....	60
Figure 16. Y-maze test in 9-month old mice.	61

Figure 17. Escape latency of the hidden-platform test and percentage of time in the probe test. .63

Figure 18. Conceptual model of Alzheimer’s disease and quetiapine’s therapeutic effects through BDNF.....71

LIST OF ABBREVIATIONS

5-HT	Serotonin
5-HT1AR	Serotonin1A Receptors
A β	Beta Amyloid
AD	Alzheimer's Disease
ANOVA	Analysis of Variance
APP	Amyloid Precursor Protein
BDNF	Brain-Derived Neurotrophic Factor
BLA	Basolateral Amygdala
BNST	Bed Nucleus of the Stria Terminalis
BPSD	Behavioural and Psychological Symptoms of Dementia
CA1	Cornu Ammonis 1
CA2	Cornu Ammonis 2
CA3	Cornu Ammonis 3
CAA	Cerebral Amyloid Angiopathy
CaMKIV	Calcium/Calmodulin-dependent Kinase IV
cAMP	Cyclic Adenosine Monophosphate
CREB	cAMP Response Element Binding
DA	Dopamine
DG	Dentate Gyrus.
DZP	Diazepam
EO	Early-Onset
EPM	Elevated Plus Maze
ETM	Elevated T-Maze
FAD	Familial Alzheimer's Disease
GAD	Generalized Anxiety Disorder
LA	Lateral Amygdala
L-VDCCs	L-type Voltage-dependent Calcium Channel
NA	Noradrenaline
NMDA	N-methyl-D-aspartate
PBS	Phosphate-buffered Saline
PCR	Polymerase chain reaction
PD	Panic Disorder
PKA	Protein Kinase A
PS1	Presenilin 1
Q5	Quetiapine 5 mg/kg/day
SPECT	Single Positron Emission Computed Tomography
SSRI	Serotonin Selective Reuptake Inhibitors
SP	Substance P
TCA	Tricyclic Antidepressants
Tg	Transgenic

CHAPTER 1: INTRODUCTION

Alzheimer's disease (AD), the most common form of dementia, accounts for roughly half of all patients with dementia. AD is a neurodegenerative condition that is distinguished by extracellular senile plaques and intracellular neurofibrillary tangles. Theoretically, these pathological changes eventually lead to brain atrophy, as well as synaptic loss and cell death (Selkoe & Podlisny, 2002; Storey & Cappai, 1999; Suh & Checler, 2002; Van Gassen & Annaert, 2003). Epidemiological investigations of AD found prevalence rates of 5% in Canadians over age 65 (Canadian Study of Health and Aging Work Group, [CSHA], 1994), and placed AD among the common causes of death with heart disease, cancer and stroke (Kung, Hoyert, Xu & Murphy, 2008). This disease manifests itself through impaired memory and decline in other related cognitive faculties, namely: aphasia (impairment of language and interpretation), apraxia (loss of different motor skills), agnosia (impairment in object recognition), and executive functioning (*Diagnostic and Statistical Manual of Mental Disorders, text revision [DSM-IV-TR]*; American Psychiatric Association, 2000; Tariot, Profenno, & Ismail, 2004).

There is now a consensus on the aetiology of AD as the last century had advances in the neurosciences, immunohistochemistry methods and brain imaging techniques (Cummings & Zhong, 2006). The amyloid cascade hypothesis suggests that there is an accumulation of beta-amyloid ($A\beta$) that is either caused by the overproduction and abnormal processing of amyloid precursor protein (APP) or by the inability to clear the expressed $A\beta$, resulting in amyloid plaque deposition. This results in a cascade of secondary actions that finally result in the cognitive and behavioural phenotypes of dementia (Cummings, Vinters, Cole & Khachaturian, 1998).

A variety of coexisting psychiatric symptoms have been reported in individuals with AD, including depression and anxiety. Dementia occurs in up to 20 percent of individuals diagnosed with anxiety disorders (Chemerinski, Petracca, Manes, Leiguarda, & Starkstein, 1998; Ferretti, McCurry, Logsdon, Gibbons, & Teri, 2001; Forsell & Windblad, 1997; Skoog, Nilsson, Palmertz, Andreasson & Svanborg, 1993; Starkstein, Jorge, Petracca, & Robinson, 2007). Further, about 70 percent of patients with dementia suffer from symptoms of anxiety (Ballard, Neil, O'Brien, McKeith, Ince, & Perry, 2000; Chemerinski et al., 1998; Cummings & Back,

1998; Lyketsos, Breitner & Rabins, 2001; Wands et al., 1990). More than half of all AD patients show symptoms of apathy, agitation, depression, anxiety and aberrant motor behaviours (Cummings, 2006). Such reports suggest that anxiety and other non-cognitive behaviours have a serious impact on a larger proportion of patients with AD.

In conjunction with advances in our understanding of the neurobiological basis of AD, there is evidence to suggest the neurobiological basis for the behavioural and psychological symptoms of dementia (BPSD). Functional neuroimaging studies have demonstrated the relationship of BPSD to the parietal lobe in anxiety and depression, and the frontal and temporal lobes in agitation and psychosis (Sultzer, 1996). Cell loss in the locus coeruleus, a major nucleus for secreting neuroepinephrine, is linked to depression (Bondareff, 1996; Lyketsos et al. 2000), and downregulation of serotonin, norepinephrine and dopamine levels in the brain stem, midbrain, and limbic regions (including the amygdala and the hippocampus) are associated with anxiety and depression (Dunlop, & Nemeroff, 2007; Lyketsos et al. 2000; Marin, 1991; Ressler, & Nemeroff, 2000). In AD, gene polymorphisms of the serotonin receptor 5-HT_{2C} and the serotonin transporter have been implicated in psychosis and agitation (Assal et al. 2004; Holmes, Arranz, Powell, Collier, Lovestone, 1998; Nacmias et al., 2001). This further emphasizes the necessity of studying BPSD and the associated brain regions affected in AD (Cummings & Zhong, 2006).

The symptoms of dementia in AD extend beyond memory impairment. As the disease progresses, the BPSD become more apparent (Cantillon et al., 1997; Scharre & Chang, 2002; Wragg & Jeste, 1989), and have a major impact on the patient's cognitive processes (Tariot et al., 2004). There is a direct relationship between the symptoms of anxiety and dementia. Seignourel, Kunik, Snow, Wilson, and Stanley (2008) reported that, depending on the brain regions that are affected, neurodegeneration will not only lead to the cognitive impairments associated with the neocortex, as extensively studied, but also will lead to behaviours associated with pathological changes in the limbic structures. Moreover, anxiety is more evident in patients affected by dementia in comparison to the rest of the geriatric population. Finally, there exists an overlap between the symptoms of anxiety and the symptoms of dementia (Seignourel et al., 2008). These observations emphasize the importance of studying the relationship between cognitive decline and anxiety in patients with AD.

Until recently, very few studies have investigated the relationship of anxiety and dementia. For instance, Starkstein et al. (2007) investigated generalized anxiety disorder (GAD) among one hundred and forty-four patients with AD, and found that “restlessness, irritability, muscle tension, fears, and respiratory symptoms in the context of excessive anxiety and worry” (p. 45), were valid symptoms for predicting GAD in AD. This is the first documented study that empirically clarifies the clinical presence of GAD in patients with AD. The criteria that Starkstein et al. measured specifically imply the need for examining the relationship between anxiety and memory in AD in order to ascertain appropriate treatment for these behaviour changes.

To date, atypical antipsychotics are the most promising and popular form of treatment used to control the BPSD in AD. Studies have demonstrated the effectiveness of atypical antipsychotics for treating cognitive impairment, and protecting neurons from dying (Carson, McDonagh & Peterson, 2006), and more recently BPSD (Rocca, Marino, Montemagni, Perrone, & Bogetto, 2007). Atypical antipsychotics, including quetiapine, are used in treating patients with BPSD such as psychoses, aggression and agitation (Caballero, Hitchcock, Scharre, Beversdorf & Nahata, 2006; Scharre & Chang, 2002; Street et al., 2000). Despite adverse effects such as increased risk of cerebrovascular events, sedation, increased body mass index, and death, Schneider et al. (2006) reported that quetiapine was the most effective atypical neuroleptic for specifically treating anxiety, psychoses, and mild cognitive impairments. These studies provide evidence for the potential of quetiapine in treating AD patients.

Familial Alzheimer’s disease (FAD) can be described as an AD phenotype that occurs in two or more family members, with or without known genetic causes. Twenty-five percent of all AD cases are of the FAD type (Bird, 2008). Bird also found that six percent of all AD cases are early-onset (EO), and approximately 60% of all EO (<60 years) cases are FAD, with 13% inherited in an autosomal dominant pattern. The discovery of genes involved in FAD, in which APP and the presenilins account for about 5% of all AD cases (Tanzi & Bertram, 2005), led to the development of transgenic animal models of AD. These transgenic models are widely used in studying drug effects as well as gene function in AD. One transgenic animal model is based on the observation that types of FAD are associated with the overexpression of APP found on chromosome 21, or mutations in the presenilin 1 and presenilin 2 genes found on chromosomes 14 and 1, respectively. The transgenic animal model incorporating both the human APP and PS1

genes exhibits high levels of A β 42(40) and A β plaques, which are not normally found in mice. A transgenic mouse model that incorporates APP and PS1 genes offer an opportunity to study reliably the AD pathology as well as drug treatments that are involved in AD.

1.1 Neurobiological/Neuropsychological Basis of Alzheimer's Disease: Amyloid Cascade Hypothesis

AD, a neurodegenerative disease associated with cognitive decline, as well as psychiatric and behavioural complications (Cantillon et al., 1998; Scharre & Chang, 2002; Wragg & Jeste, 1989), affects approximately 2% of the population in industrialized countries (<http://www.alz.org>), and is characterized by biochemical and pathological abnormalities, such as cerebral amyloid plaques, neurofibrillary tangles, and synaptic and neuronal loss in the brain. A pathological hallmark of AD is the formation of amyloid plaques, in which A β is a major component (Storey & Cappai, 1999; Suh & Checler, 2002; Van Gassen & Annaert, 2003). A β is derived through the abnormal processing of the larger transmembrane amyloid precursor protein (APP) by two enzymes: β -secretase (β -site APP-cleaving enzyme, BACE) and a presenilin (PS)-dependent γ -secretase complex (Fukumoto et al., 2004; Lazarov et al., 2005), while α -secretase cleaves the A β sequence itself and is usually considered as nonamyloidogenic (Wilquet & De Strooper, 2004). β -Secretase mediates the initial step of A β production by β -cleavage of APP, and β -secretase inhibitors reduce A β production in APP transgenic mice (Asai et al., 2006) A β load is correlated with increased β -secretase expression and enzymatic activity in sporadic Alzheimer's disease patients (Li et al., 2004; Yang et al., 2003). Together, these changes result in a cascade of secondary actions, including the hyperphosphorylation of tau protein and the development of neurofibrillary tangles, as well as free radical formation causing oxidative stress which damages and kills neurons. In addition, the neurons respond to the injury by microglial activation and cytokine production resulting in inflammation. Together, the excess of oxidative stress and excitotoxicity will lead to apoptosis and cell death (Hardy & Selkoe, 2002). As a result of this, the loss of neurons produces deficiencies in neurotransmitters, notably acetylcholine, serotonin, and noradrenaline. Finally, the loss of neurons results in the cognitive and behavioural phenotypes of dementia (Cummings et al., 1998). Increased brain A β levels and/or A β plaques may be the primary influence resulting in neuronal degeneration in AD (Hardy & Selkoe), in the

impairment of long-term potentiation in APP/PS1 transgenic mice (Chapman et al., 1999), and the inflammatory responses in transgenic models of AD (Matsuoka et al., 2001).

In both clinical and animal studies, findings have indicated two very different outcomes in levels of Brain-derived neurotrophic factor (BDNF) in the hippocampus and cortex. BDNF is a 27-kDa homodimeric protein that plays an important role in differentiation, growth, repair, cell survival and neurogenesis. The first report of changes in BDNF expression in AD was in 1991. Phillips et al. (1991) found that BDNF mRNA levels were decreased in the hippocampus of AD patients, and the decreased expression of BDNF may be related to the neuronal cell death and cognitive impairment. Further studies found reductions in pro-form of BDNF (or premature BDNF), and mRNA transcripts in the parietal cortex of AD post-mortem brains (Fahnestock, Garzon, Holsinger, & Michalski, 2002; Garzon Yu, & Fahnestock, 2002; Holsinger, Schnarr, Henry, Castelo, & Fahnestock, 2000; Michalski & Fahnestock, 2003). In animal models of AD, the conclusions have been conflicting. Szapacs, Numis & Andrews (2004) found in a APP/PS1 Tg2576 (Swe) model of AD a progressive increase in the expression of BDNF in 12 (70%) and 18 (170%) month old mice. The authors concluded that the early increases in BDNF may play a compensatory mechanism in response to neuronal degeneration associated with A β deposition. In another study, BDNF was decreased in three different mouse models of AD (Fahnestock, Garzon, Peng, Flood, Salehi & Mount, 2006). The most striking decrease was in the CRND8 strain, where BDNF mRNA levels were reduced by 41% in 12 month-old CRND8, but BDNF was also reduced in 18 month old APP and APP/PS1 Tg2576 (Swe) mice. They concluded that overexpression of APP alone was sufficient to down-regulate BDNF mRNA in cortical tissue of AD transgenic mice (Fahnestock et al., 2006). These studies illustrate that a reduction in BDNF levels is associated with increases in amyloid plaques in the AD brain (Burbach et al., 2004; Ferrer et al., 1999; Murer et al., 1999). This suggests a relationship between BDNF alterations in the hippocampus and cortex, and cognitive dysfunction. It is still unknown whether changes in BDNF levels can be found in other brain structures of AD patients such as the amygdala.

1.2 Potential Factors Involved in Anxiety and Alzheimer's Disease

The following sections compare and contrast studies that investigate the implications of behaviours in AD and the neural circuits responsible for mediating anxiety in rat and mouse

models. Furthermore, this review section assesses studies regarding the neuronal basis of maladaptive anxiety and the implications of this on memory loss. Molecular circuitries involved are also presented.

1.2.1 Anxiety

Anxiety is an adaptive emotion that prepares individuals to face and cope with potentially dangerous environmental situations (Gross, 1999). Anxiety is accompanied by behavioural and physiological responses that enable an individual to escape from danger or to avoid a potentially dangerous situation in the future (Livesey, 1986). Pathological anxiety as defined by the DSM-IV-TR (2000) as uncontrollable and excessive anxiety and worry (apprehensive expectation), for at least six months, that manifests itself in various symptoms of anxiety disorders. In GAD, the most common type of anxiety, symptoms include feelings of restlessness and fatigue, difficulty in concentrating, irritability, muscle tension and sleep disturbances (DSM-IV-TR). In simple terms, pathological anxiety is inappropriate, uncontrollable maladaptive physiological and behavioural responses accompanied by high sympathetic activity that persistently and excessively interfere with daily living activities in physical and social settings (Ohl, Arndt & van der Staay, 2008).

Pathological anxiety in humans may differ from that in animals, in that in humans there is a sense of apprehensive expectation without physiological arousal. Although it is currently impossible to detect apprehensive expectation in animals, comparable behavioural and physiological patterns of adaptive anxiety exist in animals and humans (Hall, 1936; Lang, Davis, & Ohman, 2000). Such behaviours include freezing, autonomic changes, startle, hypoalgesia, and increased urination and defecation. The neural pathways of anxiety control include the subcortical regions notably the amygdala that activates the hypothalamus which in turn activates the sympathetic system and the hypothalamic-pituitary-adrenal axis and modulates higher levels of neuronal processing (Catherall, 2003; Davis, 1998).

The difference between pathological anxiety (maladaptive) and anxiety (adaptive) is that anxiety is characterized by an adaptive response to an imminent threat. However, when anxiety circuits are overactivated, because of maladaptive behaviours or neurobiological changes, this may lead to hyperexcitable anxiety circuits that may transform normal anxiety into

pathological anxiety (Eysenck, 1992; Mathews & MacLeod, 1994). Ultimately, the anxiety circuits become more sensitive and independent from the original triggering stimuli, and no longer under conscious control. In turn, the hippocampus and cortex modulate the lower levels of neuronal processing (Catherall, 2003; Davis, 1998). Anxiety increases attention and sharpens risk assessment. However, risk assessment may become impaired in times of excessive anxiety if the hippocampus becomes over-activated, causing disturbed cognitive processing and abnormal inhibitory behaviours.

1.2.2 Clinical Anxiety in Alzheimer's Disease

Although pathological anxiety is fundamentally maladaptive, a considerable amount of distress can be present without any apparent changes in behaviour (Handley, 1995). Normal anxiety, on the other hand, is an adaptive response, which functions to protect individuals from threat and harmful situations. Few studies have investigated the relationship between the BPSD and cognitive impairment, and those that have been done produced inconsistent findings regarding this relationship (Cummings, Schneider, Tariot, Kershaw & Yuan, 2004). Anxiety alone causes a significant burden on the quality of life of the individual limiting activities of daily living, triggering sudden awakenings during sleep and impairing neuropsychological performance, without being affected by symptoms of depression (Hoe, Hancock, Livingston, & Orrell, 2006; McCurry, Gibbons, Logsdon, & Teri, 2004; Starkstein et al., 2007). A positive correlation exists between anxiety in dementia and future nursing home placement (Logsdon, Gibbons, McCurry & Teri, 2002).

Regarding demographic and socio-environmental factors, current data suggest that there is no relationship between sex, age, or education and the risk of developing anxiety in AD (Ballard, Boyle, Bowler & Lindesay 1996; Ballard et al. 2000; Hwang, Masterman, Ortiz, Fairbanks, & Cummings, 2004; Katona & Shankar, 1999; Mendez et al., 2006; Orrell & Bebbington, 1996; Ownby, Hardwood, Barker, & Duara, 2000; Paulsen, Ready, Hamilton, Mega, & Cummings, 2001). However, anxiety appears to be more prevalent in Hispanics and Asians affected with dementia, than in those with Black or Caucasian origins (Chen, Borson, & Scanlan, 2000; Ortiz, Fitten, Cummings, Hwang, & Fonseca, 2006). Thus far, studies have suggested that anxiety is relatively stable as the disease progresses until the terminal stage, when

it suddenly decreases (Chen, et al., 2000; Sclan, Saillon, Franssen, & Hugonot-Diener, 1996). However, it is possible that caregivers and clinicians may not be able to identify the symptoms because they rely heavily on verbal and motor abilities for identifying the anxiety state of the patient (Aalten, van Valen, Clare, Kenny, & Verhey, 2005). It is possible that patients unable to verbalize may still experience anxiety that goes unnoticed by caregivers and clinicians.

Studies have explored the mechanism through which changes in behaviour relate to cognitive impairment. In animals however, only a few studies have examined the effects of quetiapine in animal models of AD. Using the object recognition task, He et al. (2004), demonstrated in our laboratory (lab) that quetiapine prevented methamphetamine-induced memory impairment and neurodegeneration. In addition to this study, He and colleagues (2005a) in our lab, reported that chronic administration of quetiapine reduced anxiety-like behaviours caused by dl-amphetamine in rats.

1.2.3 Cognition and Anxiety

Cognition and anxiety together form highly complex phenomena that regulate basic survival instincts (Clement and Chapouthier, 1998). The worries, disturbing thoughts, and abnormal information processing are difficult to assess in animals at this point in time (McNally, 1998). However, there exists a relationship between cognitive processes and anxiety, and it may be that cognitive distortions are at the root of pathological anxiety (Beuzen and Belzung, 1995; McNaughton, 1997; Hindmarch, 1998). It has been argued that anxiety is the result of a gap between newly perceived information and stored information (Gray, 1990). Further, it may be that GAD is the result of cognitive impairment causing inappropriate emotional responses (McNaughton, 1997). In turn, anxiety can influence affective and declarative memories (Cahill and McGaugh, 1998; McNaughton, 1997).

Conditioned anxiety may increase sensitivity to internal and external stimuli, and sometimes can enhance cognitive performance (Battaglia and Ogliari, 2005; Ohl et al., 2003). However, pathological anxiety can impair adaptive responses in stressful situations. An individual's response to anxiety is dependent on cognition, and previously stored experiences are used as a reference point to compare current external and internal stimuli. Therefore, there is a link between the awareness of cognitive impairments and the symptoms of anxiety in dementia

(Aalten, van Valen, Clare, Kenny, & Verhey, 2005). The anxiety in dementia patients may be due in part to the awareness of one's cognitive decline and anxiety of it (Aalten, van Valen, Clare, Kenny, & Verhey, 2005; Mintzer et al., 2000). In later stages, the aetiology of anxiety in dementia becomes more complex; it is precisely the preserved verbal abilities that permit the expression of the awareness of the deficits and anxiety.

1.3 The Neurobiological/Neuropsychological Basis of Anxiety

1.3.1 Anxiety Circuit

Rosen and Schulkin (1998) reviewed studies that focused on the neural pathways involved in anxiety and provided an explanation of how the amygdala plays a key role in normal and pathological anxiety. Projections from the medial portion of the geniculate nucleus, posterior intralaminar nucleus, supragenulate nucleus, and temporal auditory and perirhinal cortices are linked directly to the lateral nucleus of the amygdala carrying auditory conditioned stimuli (Burwell, Witter, & Amaral, 1995; LeDoux, Farb, & Ruggiero, 1990; LeDoux, Sakaguchi, & Reis, 1984; MacDonald & Jackson, 1987; Romanski & LeDoux, 1993; Suzuki, 1996). The perirhinal cortex projecting to the lateral nucleus also participates in visual conditioned stimuli (Campeau & Davis, 1995b; Coordimas & LeDoux, 1995; Rosen, Hitchcock, et al., 1992). The basolateral nucleus receives projections from the hippocampus via the ventral subiculum (Canteras & Swanson, 1992) and has apparent involvement in anxiety conditioning (Maren & Fanselow, 1996). In understanding the relationship of anxiety to Alzheimer's disease, it is essential to study the amygdala, which is the core of the anxiety circuitry.

1.3.2 Amygdala

The amygdala is a fundamental neuronal structure because it is involved in emotional responses linked to novel stimuli as well as to learned stimuli. In relation to anxiety, this neuronal structure has numerous projections, particularly to the hippocampus, the cortex and the hypothalamus. For instance, as anticipatory anxiety regulation is influenced by the amygdala, the hypothalamus is linked to reactive and homeostatic anxiety regulation (Beaulieu, DiPaolo, Cote,

& Barden, 1987; LeDoux, Iwata, Cicchetti, & Reis, 1988) while the frontal cortex plays a role in the extinction of behaviour to fearful stimuli (Morgan, Romanski, & LeDoux, 1993). In relation to the amygdala, the hippocampus plays a role in context-specific processing of fearful information (Kim & Fanselow, 1992; Phillips & LeDoux, 1992). Overall, the amygdala works to assess and integrate predictable as well as unpredictable information from the internal and external environment in order to adapt and produce appropriate responses to changing environmental situations (Richardson, 1973; 1974; 1993).

The amygdala plays a key role in normal and pathological anxiety and other emotional and cognitive activities. Psychosocial stressors initiate changes in the cortico-amygdala circuitry and hyperexcitability of this circuitry is triggered through a neural sensitization process, which can also be modeled by kindling, a process in which the brain of an animal repeatedly stimulated electrically or chemically, develops seizures. Kindling amplifies an animal's perception and response of an imminent threat and danger. During anxiety, there is an increased release of glucocorticoids, which increase the corticotrophin-releasing hormone in the amygdala and the extended amygdala. Excitation of the amygdala and the extended amygdala, notably the bed nucleus of the stria terminalis (BNST), plays a major role in attention and arousal in response to anxiogenic stimuli. The amygdala and the BNST are critical for specific and nonspecific pathological anxiety (Davis, Walker, & Lee, 1997). The amygdala is involved in computing sensory and autonomic information into psychological and behavioural responses (Aggleton & Mishkin, 1986; LeDoux, Cicchetti, Xagoraris, & Romanski, 1990). More specifically, the central nucleus of the amygdala is involved in the output pathway and activates physiological, autonomic, and behavioural responses (Iwata, Chida, & LeDoux, 1987; Kapp, Gallagher, Underwood, McNall, & Whitehorn, 1982; Rosen & Davis, 1988a).

The central nucleus and other parts of the amygdala, such as the lateral and basolateral nuclei, are involved in anxiety-induced physiological responses. Such responses include bradycardia, changes in respiration, freezing, startle, and analgesia (Campeau & Davis, 1995; LeDoux et al., 1990; Roozendaal et al., 1990; Sananes & Davis, 1992; Iwata et al., 1987; Rosen & Davis, 1988a). The central nucleus also receives autonomic information from the brain stem nuclei; including the dorsal motor nucleus of the vagus, lateral hypothalamus, and the parabrachial nucleus, that control physiological responses (Koh & Ricardo, 1978; Veening, 1978). It is also worth noting that the sensory, auditory and nociceptive information from

subcortical regions also act on the central, lateral, and basolateral nuclei of the amygdala (Aggleton & Mishkin, 1986; Bernard, Alden, & Besson, 1993; LeDoux, et al., 1990; LeDoux, Sakaguchi, & Reis, 1984; Turner & Herkenham, 1991). Moreover, neurons of the lateral nucleus respond to conditioned anxiety stimuli (Quirk, Reppas, & LeDoux, 1995). Lesions in the lateral amygdala (LA) produced severe impairment of conditioned anxiety; whereas, the basolateral nuclei was associated with aversive memories (Maren, Aharonov, & Fanselow, 1996; Parent, West, & McGaugh, 1994). Lesions in the basolateral amygdala (BLA) produced severe impairment of aversive memory linked to anxiety (Maren, Aharonov, & Fanselow, 1996; Parent, West, & McGaugh, 1994). These findings suggest the involvement of the basolateral nuclei in anxiety and memory loss, topics that warrant further attention in behavioural research in AD.

Anxiety and pathological anxiety may be under the control of the BNST (Davis et al., 1997). The brainstem projections of the BNST innervate many of the same structures as the central nucleus of the amygdala (Alheid et al., 1995; Wallace, Magnuson, & Gray, 1992). Davis and colleagues investigated whether the BNST differentiates between anxiety (nonspecific stimulus) induced and anxiety (stimulus-specific) induced using the light enhanced startle reflex (Davis et al.). The authors concluded that the BNST was implicated in anxiety whilst the central nucleus was more involved in stimulus-specific anxiety response. In addition, in Hitchcock & Davis's 1991 study, the basolateral amygdala was involved in both specific and nonspecific stimuli responses. Interestingly, the molecular consequences of hyperexcitability, resulting from either long-term potentiation (LTP) or the early stages of kindling may induce the cascade of genetic events involved in the production of BDNF (Ou & Gean, 2007). The altered expression of BDNF is related to cognitive impairment and anxiety-like behaviour.

Low levels of BDNF protein in the hippocampus and the amygdala are associated with increased anxiety-like behaviours (Chen et al., 2006). In 2004, Rattiner and colleagues' genetic studies confirmed the relationship of BDNF in the BLA as they demonstrated that BDNF gene expression is increased in the BLA during acquisition of new memory in the fear potentiated startle (FPS) behavioural testing (Rattiner et al., 2004a). In addition, the tyrosine kinase B receptor in the amygdala is critical for the acquisition of conditioned anxiety (Rattiner et al., 2004a). Overall, these studies have strong implications for investigating BDNF changes in the BLA when studying anxiety in mouse models.

Küçük, Gölgeci, Saraymen, & Koç (2008) suggested that decreased BDNF in the BLA may be associated with memory impairment. These authors highlighted the signal cascades linking the initial physiological events by which fear conditioning modulates the expression of BDNF in the lateral amygdala. These authors suggest that calcium influx through N-methyl-D-aspartate (NMDA) receptors and L-type voltage-dependent calcium channels (L-VDCCs) during fear conditioning activates cAMP-dependent protein kinase (PKA) and calcium/calmodulin-dependent kinase IV (CaMKIV) resulting in cAMP response element binding protein (CREB) phosphorylation (Monfils, Cowansage & Ledoux, 2007; Ou & Gean, 2007). The phosphorylated CREB binds to BDNF promoters I and III, and up-regulates the expression of BDNF in the LA, which helps the consolidation of fear memory (Figure 1). The diagram illustrates the molecular cascade that leads to BDNF increase in the amygdala.

1.3.3 Hippocampus

Numerous studies regarding the relationship between the hippocampus and cognitive functions have been published, but even though the hippocampus plays important roles in emotion responses, there are very few publications concerning the hippocampus and anxiety. Intrahippocampal infusion studies in animals support a distinctive role of the hippocampus in anxiety. Notably, gamma-aminobutyric acid (GABA) type A receptor agonists, glutamate antagonists, serotonin antagonists and acetylcholine esterase inhibitors have reliable anxiolytic effects (Alves, Pinheiro, Motta, Landeira-Fernandez & Cruz, 2004; Degroot, Kashluba & Treit, 2001; Degroot and Treit 2002; Gonzalez, Ouagazzal, File 1998; Hackl & Carobrez 2006; Nunes-de-souza, Canto-de-Souza & Rodgers 2002; Rezayat, Roohbakhsh, Zarrindast, Massoudi & Djahanguiri, 2005). The hippocampus, according to the Papez model (1937), acts as a relay center between the cingulate cortex and the hypothalamus, facilitating emotional experience and expression respectively. Later, MacLean's (1949) theory explained that the hippocampus is the central area through which emotion-related stimuli act by filtering information to other limbic systems, such as the amygdala. In relation to anxiety, the hippocampus and the septum represent the control for behaviour inhibition (Gray, 1982). Conversely, LeDoux (2000) argued that anxiety itself, and more specifically conditioned anxiety, is linked to the amygdala, suggesting

that the hippocampus possesses a limited role as it simply codes contextual cues associated with anxiety.

Comparatively, a similar argument was presented by Davidson and Jarrard (2004), who showed that the hippocampus performs the function of associative/inhibitory conditioning in anxiety. Presumably, the hippocampus can be divided into two parts, the dorsal and the ventral regions, in which the dorsal is mainly involved in memory and learning, and the ventral mainly in anxiety (Bannerman et al., 2004). Studies remain inconclusive as to the dissociation of the hippocampal roles in anxiety and memory. This leaves the opportunity for further studies to investigate the underlying mechanisms between anxiety and memory.

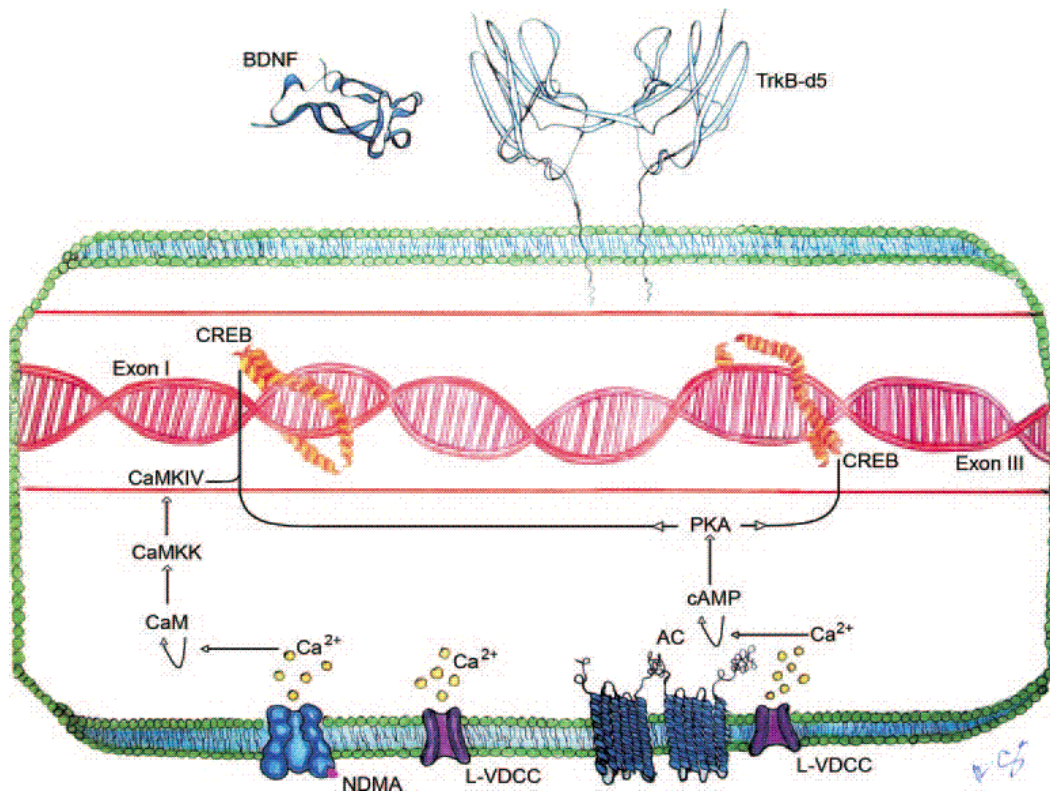

Figure 2. Diagram of the signal cascades linking the initial physiological events by which fear conditioning modulates the expression of BDNF in the lateral amygdala (LA).

Calcium influx activates cAMP-dependent protein kinase (PKA) and calcium/calmodulin-dependent kinase IV (CaMKIV) which phosphorylates cAMP response element binding protein (CREB). Phosphorylated CREB binds to BDNF promoters I and III, and up-regulates the expression of BDNF in the LA. This results in the consolidation of fear memory. (Monfils, Cowansage & Ledoux, 2007).

1.3.4 Serotonin

The monoamine neurotransmitter serotonin (5-HT) plays an important role in the pathophysiology and treatment of anxiety disorders (Baldwin, Anderson, Nutt, Bandelow, Bond, Davidson, den Boer, Fineberg, Knapp, Scott & Wittchen, 2005). Increased serotonergic neurotransmission induces anxiety-like behaviours in animals and in humans (Cloninger, 1987; den Boer, Westenberg, De Leeuw & van Vliet, 1995; Griebel, 1995; Handley, 1995; Plomin, Owen, & McGuffin, 1994). Evidence of hyperactivity of the serotonergic system causing anxiety-like behaviours also comes from studies of the 5-HT_{1A} receptors (5-HT_{1A}R). Martin & Humphrey (1994) reviewed the literature regarding the identification and cloning of the 5-HT receptor subtypes (5-HT₁, 5-HT₂, 5-HT₃). The 5-HT_{1A}R has received the most attention because of the availability 5-HT_{1A}R agonists such as busprione or 8-OH-DPAT, and because of the importance of this receptor in relation to anxiety (Coplan, Wolk & Klein, 1995; Murphy, 1990). 5-HT_{1A} receptors are coupled to G-proteins and are negatively coupled to adenylyl cyclase (Hoyer & Schoeffter, 1991; Julius, 1991). 5-HT_{1A}R are presynaptic inhibitory autoreceptors as well as postsynaptic receptors (De Vry, 1995). Activation of 5-HT_{1A}R decreases the firing rate of serotonergic neurons (Blier, de Montigny & Tardif, 1987; Jolas et al., 1993; Sprouse & Aghajanian, 1988).

Recently, Nash et al. (2008) measured in patients with panic disorder (PD), the receptor binding capabilities using a single positron emission computed tomography (SPECT) 5-HT_{1A} tracer [¹¹C]WAY-100635. The 5-HT_{1A} receptors are located both presynaptically and postsynaptically. The 5-HT_{1A} receptors were located in the different brain regions using a previously validated database (Rabiner et al., 2002), and by hand for the raphé nuclei (Nash et al.). Nash et al. used the parametric binding-potential and took the mean voxel value to calculate the regional binding potential values. In the amygdala, orbitofrontal cortex and temporal lobe postsynaptic receptors have been associated with a decrease in anxiety. In the raphé nuclei presynaptic 5-HT_{1A} receptors have also been associated with decreased anxiety. Both presynaptic and postsynaptic 5-HT_{1A} receptor binding was reduced in the amygdala, orbitofrontal cortex, temporal cortex, and raphé nuclei of untreated PD patients in comparison to healthy volunteers. Lanzenberger et al. (2007) found that patients with social anxiety disorder had lower levels of 5-HT_{1A} binding in the amygdala and anterior cingulate cortex as revealed by

[¹¹C]WAY-100635. In anxiety disorders, such as in panic disorder or social anxiety SPECT studies have shown the reduced binding of 5-HT_{1A} receptors, indicating that the 5-HT_{1A} receptors are a valid target in finding new and improved treatments for anxiety disorders.

Previous studies with 5-HT_{1A} knockout mice found an increase in serotonin neurotransmission in the dorsal raphe nuclei, hippocampus, and to a lesser extent in the cortex, and an increase in anxiety-like behaviours in the open-field test and the Porsolt forced swim test (Parks, Robinson, Sibille, Shenk & Toth, 1998). The 5-HT_{1A} can affect other neurotransmitters including dopamine (DA) and noradrenaline (NA). The medial prefrontal cortex 5-HT_{1A} increase the DA release in the ventral tegmental and the mesocortical areas (Díaz-Mataix et al., 2005). Atypical antipsychotics may elevate the extracellular levels of DA through this mechanism. The stimulation of 5-HT_{1A}s in the dorsal raphe nucleus induces a decreased NA release from the locus coeruleus (Pudovkina, Cremers & Westerink, 2002). Increased 5-HT_{1A} firing caused by acute immobilization leads to raised NA release in the hippocampus (Rioja et al., 2007). Overall, studies show that anxiety is related to elevated levels of serotonin neurotransmission —most notably through the 5-HT_{1A}.

The expression of 5-HT_{1A} receptors in the hippocampus and cortex during the first two postnatal weeks is critical for the development of anxiety-like behaviour in adulthood (Lidov & Molliver, 1982; Gross et al., 2002). Serotonin levels in the postnatal period also influence long-lasting changes in brain plasticity in visual and sensory cortices and the dentate gyrus (Cases et al., 1996; Upton et al., 1999; Haring & Yan, 1999), and the 5-HT_{1A} may be a critical mediator of the developmental effects of serotonin. Yan, Wilson & Haring (1997) found a depletion in the dendritic spine density of the dentate gyrus, after treatment with a 5-HT_{1A} antagonist (NAN-190). Gross et al. showed that expressing 5-HT_{1A}, primarily in the hippocampus and cortex, is sufficient to create a normal anxiety phenotype in 5-HT_{1A} knockout mice. They used a double transgenic mouse model carrying a rescuable knockout allele of the 5-HT_{1A} crossed with a transgenic mouse carrying the bacterial tTA protein under the control of the α -calcium-calmodulin-dependent protein kinase II (α CaMKII) promoter to achieve expression of the 5-HT_{1A} in a tissue-specific and temporally controlled manner. Essentially, this 5-HT_{1A}- α CaMKII complex is critical as it produces a cascade of events leading to prolonged changes in the brain chemistry, thus playing an important role in the development of normal anxiety-related behaviour. In brief, evidence from studies on postnatal development, spine density, or knockout

model describe the importance of the 5-HT1AR in the hippocampus and cortices in the development of the phenotype of anxiety.

1.3.5 Avoidance and Escape

All forms of anxiety can be categorized into two main types: conditioned anxiety also known as avoidance, and unconditioned anxiety also known as escape. Studies investigating the neurobiological basis of avoidance have revealed the specific connections involved in each type. An identifiable region associated with avoidance that can be studied clearly in the mouse is the BLA. For instance, projections from the BLA to the striatum are related to avoidance behaviour (Everitt & Robbins, 1992). In addition, BLA projections to the forebrain may be involved in attention and vigilance (Gallagher & Holland, 1994). An even higher-order region of control involved in this context-specific process is the prefrontal cortex. Here, the prefrontal cortex is involved in behaviour extinction in relation to conditioned anxiety (Gray & McNaughton, 1996). These areas should be studied in future investigations.

There has also been an accumulation of evidence that supports the importance of the central nucleus of the amygdala in avoidance behaviour. Information pertaining to anxiety and anxiety-related stimuli, travel either directly to the central nucleus, or go through the basolateral nucleus before arriving at the central nucleus of the amygdala (Pitkanen et al., 1995; Stefanacci et al., 1992). The basolateral nucleus projections to the lateral BNST may also be involved in avoidance behaviour (Davis, et al., 1997; Deasy, Shi, & Davis, 1997). Overall, both the central nucleus of the amygdala and the lateral BNST project through the ventral amygdalofugal pathway directly to many diencephalic, midbrain, and brain stem structures. Evidence also suggests that the hippocampus plays a role in context-specific processing of anxiety-related information (Kim & Fanselow, 1992; Phillips & LeDoux, 1992). Risk assessment and behavioural inhibition are main responses that occur and are associated with the septohippocampal region (Gray & McNaughton, 1996).

The second form of anxiety, unconditioned anxiety, can be described as the desire to escape from a threatening dangerous or unpleasant environment. It is also important to understand the neurobiological basis of escape in an effort to differentiate pathways involved in conditioned anxiety or avoidance. The periaqueductal gray plays a central role as an output

pathway in escape behaviour (Bandler & Shipley, 1994; Carrive, 1993; Fanselow, 1994). The stimuli that activate the nucleus reticularis pontis caudalis create a startle response in rodents (Davis, Gendelman, Tischler, & Gendelman, 1982; Lee, Lopez, Meloni, & Davis, 1996), where input from the central nucleus of the amygdala boosts the startle response (Rosen & Davis, 1988b, 1990; Rosen et al., 1991). An important target region of the central nucleus of the amygdala is the periaqueductal gray in the midbrain that controls defensive behaviours, such as escape (Bandler & Shipley, 1994; Fanselow, 1994; Hostege, 1995). Studies that investigate anxiogenic changes should differentiate the neurobiological pathways involved in avoidance from those involved in escape.

1.4 APP/PS1 Transgenic Mouse Model of Alzheimer's Disease

1.4.1 Relevance of Transgenic Mouse Studies to Clinical Trials

Further evidence of the neurobiology of AD comes from animal models based on the genetics linked with FAD patients. The understanding of the genes involved in FAD has provided us with a useful model in studying the various aspects of the disorder. Transgenic mouse models of AD are based on mutations found in FAD patients' genes, particularly *APP* or the genes coding for the presenilin (PS) enzymes PS1 and PS2. Games et al. (1995) constructed a PDAPP V717F transgenic mouse model that developed A β plaque depositions in the brain comparable to those of AD patients. These mice overexpressed a mutated form of human APP that resulted in an A β load by 6 months, and by 18 months in mild deposits in the walls of the blood vessels of the brain comparable to the cerebral amyloid angiopathy (CAA) observed in AD patients. Hsiao et al. (1996) published a report describing a convincing mouse model of AD. These authors created a Tg2576 transgenic mouse line carrying a human APP complementary DNA with double Swedish mutation (K670N and M671L) under the control of hamster prion protein promoter (PRP). Heterozygous Tg2576 mice produced APP 5.5-fold over wild type endogenous levels and developed diffuse and neuritic plaques in the hippocampus, cortex, subiculum, and cerebellum at around 9 to 11 months of age. These pathological changes result in memory deficits in mice as observed in the water maze test that are comparable to the memory

deficits seen in patients with AD. CAA is practically non-existent in these mice at 18 months of age (Hsiao et al., 1996).

Currently most studies investigating treatment for AD use the PDAPP or the Tg2576 mouse lines. Other models in this category include the APP23 (K670N/M671N), which produces higher levels of human APP than does the Tg2576 (Sturchler-Pierrat, 1997). Also, the TgCRND8 mouse affects both β -secretase and γ -secretase activities, and has a very aggressive rate of A β deposition because it carries both the Indiana (V717F) and the Swedish (K670N/M671L) mutations (Chishti et al., 2001). While the APP: V717I mouse carries a different APP mutation, it closely resembles the PDAPP mouse (Moechars et al., 1999). The first mouse model to produce the tau pathology is the APP23 (Calhoun, 1998). These APP23 transgenic mice upregulate APP, increase hyperphosphorylation of tau, and produce mild cortical neuronal loss. Ultimately, these transgenic mouse models of AD provide researchers with opportunities to test and discover the underlying mechanisms of therapeutic agents involved in treating the symptoms associated with AD.

The double transgenic mouse model of AD produced by crossing mice expressing the M146L mutation in PS1 with Tg2576 mice markedly accelerates the rate of A β deposition in the brain and produces more of the fibrillogenic A β 1-42 species (Holcomb et al., 1998). Mice with single mutations in PS1 do not express the A β plaques until many months later (Duff et al., 1996). Newer AD mouse models have introduced mutations in tau protein. The discovery that mutated tau protein is involved in frontotemporal dementia (FTD) has led to the development of a mutated tau transgenic animal model. Lewis et al. (2000) created the JNPL3 mouse, the first transgenic mouse model to incorporate a tau mutation, the human tau P301L. The JNPL3 mouse develops hyperphosphorylation of tau protein in the dendrites and soma of neurons, which results in the formation of neurofibrillary tangles (Lewis et al., 2000). Oddo et al. (2003) created a triple transgenic, 3XTg mouse model of AD. This model carries APP (Swedish, Tg2576), PS1 (M146L), and tau (P301L) human mutations, and these mice express significant intracellular A β and hyperphosphorylated tau, and extracellular A β deposits (Oddo et al., 2003). However, stereological methods demonstrated no significant loss of neurons (Oddo et al. 2003). Several other transgenic mouse models of AD also show promise. Capsoni et al. (2000) created a mouse model expressing recombinant antibodies blocking nerve growth factors causing both A β plaques and tau pathology.

Recently, Colton et al. (2006) created a mouse model combining APP (Tg2576) with a nitric oxide synthase 2 knock-out, which produces A β plaques, hyperphosphorylated tau, and neuronal loss. Finally, a model of vascular dementia, APPSwDI (K670M/N671L, E693Q, and D694N), shows a rapid progression of A β deposition particularly associated with the vasculature (Davis, 2004). However, what is fascinating about this model is that it has a deficiency in the clearance of A β across the blood-brain barrier (Davis, 2006). This is one of the very first models to actually mimic the lack of clearance of A β from the brain similar to that seen in CAA patients.

Some of the functional disruptions in the Tg2576 mouse include impairment of LTP, synaptic disruption, dystrophic neurites and gliosis in the hippocampus and in the cortex. The overexpression of human APP clearly accounts for much of the A β pathology. As demonstrated in the Y-maze and Morris Water maze, APP transgenic mice have significant cognitive impairment (He et al., 2007). However, APP mutations are only part of the AD puzzle as presenilins also play an important role in FAD. In 1996, Duff and collaborators constructed mice expressing the mutant presenilin genes. The mutant presenilins act in a dominant fashion in mice expressing the PS1 transgene, and selectively increase A β 42(43) levels. As described earlier, the interaction of presenilins and APP encourage the formation of fibrillogenic plaques, by altering the processing of APP. Crossing Tg2576 mice with PS1 M146L mice significantly increases A β 42(40) levels and accelerates the deposition of A β plaques compared with single transgenic mice Tg2576 (Hsiao et al., 1996; Games et al., 1995; Holcomb et al., 1998; Sturchler-Pierrat et al., 1997). Transgenic animals currently available are reliable, valid and highly useful models for studying diseases such as AD and for providing insight into the pathogenesis and potential pharmacological treatments of AD.

1.4.2 Anxiety-Like Behaviour in APP/PS1

A review of the literature shows that there exists a number of conflicting findings regarding the APP/PS1 and the phenotype of their anxiety-like behaviours. For instance, in one study using single transgenes, Ognibene et al. (2005) showed that mice overexpressing APP, such as APP23 (APP751) and Tg2576 (APP695), either show no change or a distinct reduction in anxiety in the elevated plus maze (EPM). Contrary to Ognibene et al. (2005), Lee et al. (2004)

reported that mice expressing the Swe/Indiana mutated APP exhibit increased anxiety levels and microarray analysis revealed altered gene expression by more than two folds in the amygdala. The expressions of tumor necrosis factor- α , T-LAK, cell-originated protein kinase, hematopoietic-cell specific Lyn substrate 1, calmodulin 4, and transthyretin were increased by 13 months of age; whereas X (inactive)-specific transcript, chemokine (C-C motif) ligand 6, and cullin 4B were decreased. However, single transgenes may not be appropriate models of AD. Arendash et al. (2001) found no significant changes in anxiety levels of APP/PS1 when tested in the EPM. Furthermore, findings by Jensen et al. (2005) support decreased levels of anxiety in the APP/PS1 on the EPM. Despite the use of double transgenes, neither Arendash et al. (2001) nor Jensen et al. (2005) found increased levels of anxiety elicited by the EPM, but a recent study by Pugh et al. (2007) demonstrated increased levels of anxiety in the APP/PS1 mouse model of AD that was associated with the onset of the neuropathology and the A β plaque deposition. Our AD model (He et al., 2007), carrying APP and PS1 mutated genes, not only showed accelerated AD-like plaque load and memory impairment, but also increased anxiety-like behaviours.

1.5 Behavioural Testing: The Elevated T Maze

1.5.1 Overview of the Elevated T-Maze (ETM)

As it is recognized that anxiety is comprised of various types of clinical manifestations (DSM-IV, TR, 2000), it is imperative that measures of anxiety show specificity in accordance to the type being studied. The elevated T-maze (ETM), a derivative of the elevated plus-maze (EPM), is exemplary in its inherent ability to produce robust measures of anxiety in mice (Jardim, Nogueira, Graeff & Nunes-de-Souza, 1999). The ETM was developed on the hypothesis that conditioned and unconditioned responses of anxiety can be separately measured in rats (Zangrossi & Graeff, 1997). Zangrossi and Graeff found that conditioned anxiety, or inhibitory avoidance, appears to be related to GAD-like behaviours, whereas unconditioned anxiety, or one-way escape, appears to be related to PD-like behaviours.

Physically, the ETM apparatus is a simple design. It is composed of three arms of equal dimensions, elevated 50 cm above the ground. One of these arms is enclosed, for the purpose of concealing the rodent's vision from the perpendicular arms until it has passed the lateral walls.

Inhibitory avoidance is measured as the mean latency for the rodent to leave the enclosed arm and enter the open arms in three consecutive trials. One-way escape is measured as the mean latency of the rodent to escape from the open arms and enter into the closed arm, again in three consecutive trials. The observations that occur are that the rodent learns to *avoid* the open arms when repeatedly placed inside the enclosed arm. When the rodent is placed at the end of the open arm it escapes and rapidly enters the closed arm. Therefore, inhibitory avoidance represents learned anxiety or conditioned response, while escape represents innate anxiety or unconditioned response. It is suggested that the ‘openness’ is the main factor motivating both inhibitory avoidance and one-way escape in the ETM (Zangrossi & Graeff; 1997).

The efficacy of the elevated T-maze (ETM) as a model of anxiety and memory was first documented in a study by Graeff, Viana & Tomaz (1993) using rats (see also De-Mello & Carobrez, 2002; Viana et al., 1994), and was later empirically supported by evidence of ethological validity of the apparatus for use with mice (Carvalho-Netto & Nunes-de-Souza, 2004; Jardim, Nogueira, Graeff & Nunes-de-Souza, 1999; Zangrossi & Graeff, 1997). The presence of the open and enclosed arms at an elevated level in the ETM model is its ethological hallmark feature because they reliably elicit natural anxiety among rodents. In other words, a rodent’s presence on the open arm of an elevated maze is an unpleasant and rather maladaptive experience (Treit et al., 1993). Such a circumstance is readily controlled in a lab setting because it naturally induces anxiety. Inhibitory avoidance and one-way escape in the ETM both result from the openness in this maze. The repeated exposure to the ETM induces the mice to learn an inhibitory (passive) avoidance of the open arms (i.e. increased latencies to leave the enclosed arm over three consecutive trials) which is comparable to the anxiety that mice would experience in the wild when they encounter heights and open spaces (Graeff, Netto & Zangrossi, 1998). In lab studies, the acquisition of inhibitory avoidance is long-lasting, even 120 days after the training period; the rodents still avoid the open arms (Sanson & Carobrez, 1999). This test is based on the natural aversion of rodents towards a novel open and elevated, and potentially dangerous area.

Torrejais et al. (2008) used multivariate methods to assess the specificity of anxiety measures for PD-like and GAD-like behaviours. The results from factor analyses not only supported the heterogeneity of anxiety, revealing various types, but also the validity of the ETM in evoking expressions of both PD-like and GAD-like behaviour depending on the procedure

used. Such studies indicate that the ETM is useful in assessing different sub-types of anxiety in mice.

1.5.2 Pharmacological Studies Using the ETM

Due to the reliability as well as construct and ethological validity of the ETM for eliciting anxiety in rodents, pharmacological studies of drug treatment for anxiety can capitalize on the ETM as well. The significance of the ETM as a function of specific anxiety measures is that the effectiveness of anxiety-related drug treatments can be tested. There is an extensive literature based on using the ETM for pharmacological studies of the acute and chronic effects of conventional anxiolytics given to humans for GAD and PD. As previously mentioned, GAD is an anxiety disorder that is characterized by inappropriate, excessive, uncontrollable and often irrational worry (DSM-IV-TR, 2000). Panic Disorder, classed as an anxiety disorder, is characterized by recurring brief, inappropriate and unpredictable periods of extreme anxiety. Typically these attacks last about ten to twenty minutes and are accompanied by exaggerated symptoms of anxiety such as excessive perspiration, dizziness, airway constriction, trembling, tachycardia, hyperventilation, uncontrollable fear, derealization, depersonalization (DSM-IV-TR). Studies in ETM have shown that acute administration of diazepam, buspirone or ritanserin, selectively impairs inhibitory avoidance acquisition (IAA) yet does not affect escape (Graeff, Netto & Zangrossi, 1998; Pinheiro, Zangrossi, Del-Ben & Graeff, 2007). In contrast, escape in the ETM is impaired only by chronic treatment with panicolytic agents, namely imipramine and fluoxetine (Poltronieri, Zangrossi & Viana, 2003; Teixeira, Zangrossi & Graeff, 2000). Clinical observations have shown that GAD is responsive to most tricyclic antidepressants (TCA), selective serotonin reuptake inhibitors (SSRI), benzodiazepines, buspirone and ritanserin. Whereas, PD is unresponsive to most benzodiazepines, buspirone and ritanserin. Moreover, PD is best overcome by chronic treatment with panicolytic agents including imipramine and fluoxetine (Ballenger, 1993; Liebowitz, 1989; Nutt, 1991; Sheehan, 1999; Pollack et al., 1996).

Evidence from the use of the ETM in pharmacological studies shows differing effects of two classes of anxiolytics. Benzodiazepine receptor agonists, such as diazepam, and 5-HT_{1A} agonists, such as buspirone, impair inhibitory avoidance while leaving escape performance unaffected (Graeff et al., 1993; Viana et al., 1994; Graeff et al., 1998). These pharmacological

results suggest that inhibitory avoidance is related to GAD. In contrast, escape performance is impaired only by chronic administration of drugs such as imipramine (Teixeira et al., 2000), clomipramine or fluoxetine (Poltronieri et al., 2003), which are used to treat PD. Drugs acting on serotonergic receptors in the dorsal raphé nucleus such as kainic acid, and D-fenfluramine facilitate avoidance and impair the one-way escape behaviours in the ETM (Graeff, Viana & Mora, 1996). These studies of anxiety using mice and the ETM provide further evidence consistent with the ETM eliciting two specific types of anxiety, as well as evidence for effective drug treatment for PD-like and GAD-like anxiety.

Acute injection of sibutramine decreased inhibitory and one-way escape in the ETM (Jorge, Pobbe, Soare, Oliveira & Zangrossi, 2004), while buspirone impaired the inhibitory avoidance, but had no effect on the one-way escape. This differentiation of drug treatment on the two specific types of anxiety warrant further attention to the underlying mechanisms through which the drugs actually produce their effect. It is possible that other factors related to brain function, may be involved in the selectivity of drug response to conditioned versus unconditioned anxiety. Overall, this pharmacological profile supports the view that ETM generates GAD-like and PD-like behaviours in not only the rat but also the mouse (Jardim, Nogueira, Graeff & Nunes-de-Souza, 1999).

Gomes et al (2009) investigated the effects of acute (a single intraperitoneal injection 30 min before testing) and chronic (daily i.p. injections for 15 consecutive days) treatment with imipramine and fluoxetine, on inhibitory avoidance and one-way escape of mice in the ETM. Acute fluoxetine (0, 5, 10, 20 or 40 mg/kg, i.p.) treatment increased the inhibitory avoidance and decreased the open arm withdrawal, whilst chronic treatment (0, 5, 20 or 40 mg/kg, i.p.) decreased the inhibitory avoidance acquisition and increased the escape latency. On the other hand, neither acute nor chronic treatment with imipramine (0, 1, 5 or 10 mg/kg, i.p.) had an effect on the behaviour of mice in the two ETM tasks. These results suggest that inhibitory avoidance acquisition is a useful task for the evaluation of acute and chronic effects of anxiolytic treatment on anxiety in mice.

1.5.3 Neuronal Connectivity and Anxiety

Studies have found that the ablation of the amygdala or hippocampus reduces passive avoidance of the open arms in the ETM indicating a reduction in anxious behaviour or perhaps impaired memory associated with anxiety (Coover, Trivedi & Heldt, 2002; Trivedi, Heldt & Coover, 2004). Viana and colleagues' (2008) publication revealed activation of 5-HT_{1A} receptors of the lateral septum (LS), a region with a high density of these receptors, is implicated in inhibitory avoidance as well as one-way escape in the ETM. This finding suggests that 5-HT_{1A} activity in the LS may be involved in the neurobiology of anxiety. The effects of 8-OH-DPAT, a 5-HT_{1A} and 5-HT₇ agonist, were compared to the effects of the benzodiazepine receptor agonist midazolam (MDZ, 20 nmol) (Viana, et al., 2008). Also the administration of intra-LS injection of the 5-HT_{1A} receptor antagonist WAY-100635 (0.37 nmol) was able to block the effects of 8-OH-DPAT. Results revealed that whereas intra-LS administration of MDZ decreased avoidance latencies, suggesting an anxiolytic action, 8-OH-DPAT caused increased avoidance, suggesting an anxiogenic action. Neither drug affected the escape performance. Intra-LS administration of WAY-100635 blocked the anxiogenic effect caused by 8-OH-DPAT. This is evidence that LS 5-HT_{1A} receptors are involved in inhibitory avoidance and a malfunction of this mechanism shares a relationship with the mechanism of action of GAD (Viana, et al., 2008).

Duzzioni et al. (2008) investigated the relationship between substance P (SP), an agonist of NK₁, and diazepam (DZP) in the modulation of anxiety and memory in rats in the ETM, and found that pretreatment with DZP (1mg/kg, i.p.) significantly decreased the latency of the rats to leave the enclosed arm of the ETM. However, DZP did not decrease the latency of the rats to leave the enclosed arm when SP was pre-administered (10 pmol, i.c.v.). This maladaptive behaviour was interpreted as representing both an anxiolytic, in the test period, as well as amnesic outcome, in the re-test periods. Their study also showed an interaction between the tachykinergic and benzodiazepine–GABA systems in the modulation of anxiety. SP may block the anxiolytic effects produced by DZP. Furthermore, in 2003 Strauss et al. reported that the amygdala plays a critical role in the modulation of anxiety. After male rats had received bilateral N-methyl-D-aspartate (NMDA)-induced lesions of the amygdala, they were tested on the ETM, 2, 7, or 14 days later. They found that the inhibitory avoidance was impaired for 14 days after the procedure. These findings reflect anxiolytic effects due to the lesions in the animal's amygdala.

Particularly relevant to the present study, Tomaz et al. (1991) have shown that large NMDA-induced lesions of the amygdala impaired, but did not block, acquisition of inhibitory avoidance, thus suggesting that other brain structures are also involved in the acquisition of this behavioural response. A possible candidate is the hippocampus. Trivedi and Coover (2004) studied the effect of electrolytic lesions of the dorsal and ventral hippocampus on locomotor activity and on anxiety-like behaviour in the ETM. Lesions in the ventral hippocampus reduced the latency to emerge from the enclosed arm on trials 2 and 3 of the ETM, and again, no effect was observed in the one-way escape. The ventral hippocampus may be specifically involved in modulating conditioned anxiety and memory aversive experience related to the open arms; through hypothalamic and amygdaloid connections. Furthermore, Treit and Menard (1997) have shown that bilateral electrolytic lesions of the amygdala or the hippocampus, but not of the septum, caused a distinct and selective impairment of inhibitory avoidance. On the other hand, lesions of the septum increased open arm exploration in the elevated-plus maze (EPM) whereas lesions of the amygdala or the hippocampus had no effect. Together, these results led the authors to propose that the amygdala and the hippocampus may be part of a pathway specialized for passive avoidance of painful or anxiety-inducing stimuli. Lesions appeared to be mainly concentrated in the lateral, basolateral, and basomedial nuclei. This opens the opportunity for future studies to investigate these neuronal regions and their implications in anxiety.

1.6 Quetiapine's Effect in Alzheimer's Disease

1.6.1 Atypical Antipsychotics

Antipsychotic drugs having therapeutic efficacy in treating schizophrenia are divided into two groups, typical (conventional) and atypical (novel). Typical antipsychotics, represented by chlorpromazine and haloperidol, ameliorate only the positive symptoms. Atypical antipsychotics, including clozapine, olanzapine, quetiapine, and risperidone, are effective in treating the positive, negative, and cognitive symptoms, and have a low association with dyskinesia or parkinsonism (Velligan et al., 2002; Purdon, Malla, Labelle & Lit, 2001; Beasley, Tollefson & Tran, 1997; Cuesta, Peralta, & Zarzuela, 2001; Jann, 2004). Clinical studies have found atypical antipsychotics to be effective in the treatment of a wide range of neuropsychiatric conditions,

including depressive symptoms associated with psychotic and mood disorders (Brugue & Vieta, 2007), posttraumatic stress disorder (Pae et al., 2008), and psychosis in Alzheimer's disease (Madhusoodanan, Shah, Brenner & Gupta, 2007). Olanzapine, quetiapine, and risperidone have beneficial effects on neurocognitive functioning in patients with early psychosis (Keefe et al., 2007), and quetiapine also improves psychotic symptoms and cognition in Parkinson's disease without worsening motor symptoms (Juncos et al., 2004).

Both typical and atypical antipsychotics bind to dopamine receptors, and the blockade of dopamine D2 receptors in the mesolimbic region is thought to be the mechanism responsible for the reversal of positive symptoms by antipsychotics (Wong & Van Tol, 2003). Atypical antipsychotics also bind to serotonin (5-HT) receptors. The different affinities of antipsychotics for brain dopamine D2 and 5-HT_{2A} receptors may be helpful in understanding some of the different therapeutic effects of atypical antipsychotics (Kapur, Zipursky & Remington, 1999; Seeman & Talerico, 1999). However, the mechanisms underlying their therapeutic effects on negative and cognitive symptoms of schizophrenia may go beyond the dopamine and serotonin receptor blockade effects, this requires further investigation.

Neuroanatomical and clinical studies of schizophrenia suggest that progressive neuropathological changes, such as neuronal atrophy and/or cell death, occur over the course of the disease (Woods, Yurgelun-Todd, Benes, Frankenburg, Pope & McSparren, 1990; Waddington, O'Callaghan, Buckley, Larkin, Redmond, Stack & Ennis, 1991; DeLisi, Sakuma, Tew, Kushner, Hoff & Grimson, 1997; Arnold & Trojanowski, 1996). Cognitive deficits tend to occur early in the course of schizophrenia, and the severity of deficits is predictive of the social and occupational functioning as well as the long-term treatment outcome for patients (Green, 1996). Neural injury or neurodegeneration may cause cognitive deficits in schizophrenia (Harvey, 1998). Therefore, the beneficial effects of atypical antipsychotics on behaviour may be related to their possible effects on neuroprotection and/or neurogenesis beyond the dopamine and serotonin receptor blockade effects.

1.6.2 Neuroprotective Properties of Quetiapine and Other Atypical Antipsychotics

Quetiapine (Seroquel®) is an atypical antipsychotic drug possessing properties that have an effect on an array of psychotic and mood disorders (data on file, AstraZeneca Pharmaceuticals, Wilmington, DE, USA). For instance, this drug has been shown to effectively alleviate positive and negative symptoms, as well as cognitive impairment, in schizophrenia patients (Velligan et al., 2002; Velligan, Prihoda, Sui, Ritch, Maples & Miller, 2003; Purdon et al., 2001). Quetiapine has been used effectively in the treatment of schizophrenia since 1997 (Srisurapanont et al 2004), and of manic episodes of bipolar disorder since 2003 (Berk & Dodd 2005; Calabrese et al., 2005; Croissant et al., 2006). Quetiapine is also approved for the treatment of patients' depressive disorder (Todder et al., 2006; Baune et al., 2007). Preliminary evidence suggests a role for quetiapine in managing symptoms of anxiety in bipolar disorder (Hirschfeld et al., 2006).

Studies have demonstrated that quetiapine seems to work by targeting dopamine and serotonin neurotransmission in the pre-frontal cortex, striatum, limbic system, and anterior pituitary (data on file, AstraZeneca Pharmaceuticals, Wilmington, DE, USA; Jensen et al., 2008). Quetiapine is a dibenzothiazepine derivative that has a greater affinity for serotonin 5-HT₂ receptors than dopamine D₂ receptors, together with considerable activity at histamine H₁ receptors, and at α ₁- and α ₂-adrenergic receptors. Studies have concluded that quetiapine is a competitive antagonist at D₂ and 5-HT₂ receptors, and acts as a partial agonist at 5-HT_{1A} receptors (Jensen et al., 2008; Arango & Bernardo, 2005; Todder et al., 2006; Dannlowski et al., in press). Evidence from clinical studies has demonstrated the effectiveness of atypical antipsychotics in treating the psychotic symptoms associated with dementia (Tariot, 2004). Quetiapine is considered to be very effective in treating patients with dementia, not only because of its low propensity for extrapyramidal symptoms, but also for treating a range of BPSD symptoms.

In animal studies, quetiapine attenuates the methamphetamine-induced neurotoxicity and memory impairment (He et al., 2004; He, Yang, Yu, Li, & Li, 2006b), alleviates the amphetamine-induced anxiety-like behaviours (He, Xu, Yang, Zhang, & Li, 2005a), and counteracts the phencyclidine-induced reference memory impairment and decreased Bcl-X_L/Bax ratio in the cortex of rats (He, Xu, Yang, Rajakumar, Li, & Li, 2006a). In a clinical study,

quetiapine was shown to improve psychotic symptoms and cognition in Parkinson's disease (Juncos et al., 2004). In addition, quetiapine effectively alleviated psychoses in AD, but its possible beneficial effects on cognition in AD remain uncertain (Scharre & Chang, 2002; Caballero et al., 2006). This uncertainty of quetiapine's effect on cognition implies that future studies should investigate whether quetiapine has beneficial effects on cognitive impairment in AD and acts as a neuroprotectant in treating its pathological changes.

Atypical antipsychotics increases the levels of BDNF, an important neurotrophin mainly expressed and distributed in brain neurons (Xu et al., 2002). Neurotrophins are growth factors that act directly on neurons to support their growth, differentiation, and survival (Yuen and Mobley, 1996). Xu and colleagues (2002) documented that quetiapine attenuated the immobilization stress-induced decrease in BDNF expression in the rat hippocampus. Later studies concluded that atypical antipsychotics also modulated the level of other growth factors, such as fibroblast growth factor 2 (FGF-2) and nerve growth factor (NGF), that may play important roles in changing synaptic plasticity, normalizing cognitive deficits, and preventing cell degeneration (Parikh, Evans, Khan & Mahadik, 2003; Fumagalli et al., 2004). Building upon these findings, other studies were able to demonstrate that atypical antipsychotics increased the level of Bcl-2 and modulated the Bcl-X_L/Bax ratio in the brain. Bcl-2, a neuroprotective protein, inhibited apoptosis by sequestering proforms of death-driving caspases and preventing the release of mitochondrial apoptotic factors into the cytoplasm (Adams & Cory, 1998; Bai, Zhang & Li, 2004; Bruckheimer, Cho, Sarkiss, Herrmann & McDonnell, 1998). The mRNA and protein expression of Bcl-2 in rat frontal cortex and hippocampus were increased after chronic atypical antipsychotic treatment (Bai et al., 2004). In addition, olanzapine drug treatment prevented methamphetamine-induced Bcl-2 decrease and accelerated the restoration of Bcl-2 in hippocampal neurons from the repeated restraint stress-induced decrease (He, et al., 2004; Luo, Xu & Li, 2005). Furthermore, in their study, Wei, Mousseau and colleagues (2003) reported that atypical antipsychotics attenuated neurotoxicity of β -amyloid by modulating Bax and Bcl-X_{L/S} expression and localization in PC12 cells. In addition, He, Xu and colleagues (2006) revealed that quetiapine attenuated the phencyclidine-induced decrease in the Bcl-X_L/Bax ratio in the posterior cingulate cortex in rats. In vivo studies have demonstrated the neuroprotective properties of quetiapine and other atypical antipsychotics, particularly through the modulation of growth factors and inhibiting apoptosis.

In *in vitro* studies, quetiapine was effective in reducing PC12 cell death induced by serum withdrawal or by oxidative stress induced by hydrogen peroxide, β -amyloid peptide, or MPP⁺ (Bai et al., 2002; Qing, Xu, Wei, Gibson & Li, 2003; Wei, Bai, Richardson, Mousseau & Li, 2003; Wei, Mousseau, Richardson, Dyck & Li, 2003). Atypical antipsychotics have antioxidant properties. Studies were able to demonstrate that clozapine, olanzapine, quetiapine, and risperidone increased the gene expression of superoxide dismutase (SOD1) in PC12 cells, and prevented cell death after serum withdrawal (Bai et al., 2002; Li et al., 1999). Atypical antipsychotics may have a common antioxidant action that would be responsible for their cytoprotective effects in reducing PC12 cell death induced by serum withdrawal or by the addition of hydrogen peroxide, β -amyloid peptide, or MPP⁺ (Bai et al., 2002; Qing et al., 2003; Wei, Bai et al., 2003; Wei, Mousseau et al., 2003). Olanzapine and quetiapine prevented PC12 cells from A β -induced apoptosis and the overproduction of intracellular reactive oxygen species, attenuated A β -induced activity changes of the antioxidant enzymes (SOD1, catalase, and glutathione peroxidase), and blocked A β -induced decrease in mitochondrial membrane potential in PC12 cells (Wang, Xu, Dyck, & Li, 2005). In a clinical study atypical antipsychotics also induced other neuroprotective effects, such as olanzapine's effect of increasing gray matter volume and reducing symptoms of psychopathology in schizophrenia (Lieberman et al., 2005). Overall, *in vitro* studies suggest the neuroprotective effects of atypical antipsychotics may be explained in part by their antioxidant properties.

1.6.3 Neurogenesis, Atypical Antipsychotics and Alzheimer's disease

Neurogenesis, or neuronal regeneration, is a process of producing new functionally integrated neurons from progenitor cells (Ming & Song, 2005). Atypical antipsychotics increase cell proliferation and neurogenesis in adult rat brain (Kodama, Fujioka & Duman, 2004; Wakade, Mahadik, Waller & Chiu, 2002). Although the function of neurogenesis in the hippocampus of the APP/PS1 mouse model is unknown, clinical evidence also supports the importance of the formation of new neurons in the hippocampus (Roy et al., 2000). The formation of some types of memory relies on the continuous production of new hippocampal neurons throughout adulthood (Bruehl-Jungerman, Rampon & Laroche, 2007). Therefore, it is

possible that the beneficial effects of atypical antipsychotics on learning and memory may be linked to their up-regulation of neurogenesis.

The hippocampus may be unique, in that it continues to produce new neurons throughout life, and this may be enhanced in AD (Verret, Jankowsky, Xu, Borchelt & Rampon, 2007). Targeting neurogenesis in the hippocampus may be a potential therapy for delaying or reversing the progression of AD. Postmortem brain studies in AD patients show increased hippocampal neurogenesis in the DG and CA1 (Jin et al., 2004), consistent with our recent findings in the APP/PS1 (Yu et al., in press). Neurogenesis can be found throughout adulthood in the brain (Lie, Song, Colamarino, Ming & Gage, 2004), and can be further stimulated by neuropathological conditions. Neurogenesis was increased in the dentate gyrus after transient global ischemia in gerbils (Liu et al., 1998), in the hippocampus of rodents in an epilepsy model (Parent et al., 1997), and in the adult human Huntington's disease brain (Curtis et al., 2003). The increased neurogenesis observed in AD may be a compensatory response to pathological and behavioural impairments.

1.6.4 Atypical Antipsychotics Including Quetiapine: Effects in Alzheimer's Disease and the APP/PS1 Transgenic Mouse Model

Preliminary animal studies revealed that quetiapine and olanzapine expressed their neuroprotective properties when facing endogenous or exogenous insults. In rat studies chronic administration of quetiapine prevented the methamphetamine-induced recognition memory impairment and dopaminergic terminal loss (He et al., 2006), and alleviated the anxiety-like behaviours induced by a neurotoxic regimen of dl-amphetamine (He et al., 2005). Similarly, mouse studies showed that quetiapine attenuated spatial memory impairment, depressive and anxiolytic-like behaviours, as well as hippocampal neurodegeneration in a global cerebral ischemia model (Yan, Bi et al., 2007; Yan, He et al., 2007). Zhang and colleagues (2008) also showed that quetiapine alleviated the cuprizone-induced white matter pathology in the brain of C57BL/6 mouse while Xiao and colleagues (2008) showed that quetiapine prevented myelin breakdown induced by cuprizone in mice. In studies of olanzapine in our lab, pretreatment of rats for 2 weeks with olanzapine prevented the methamphetamine-induced 24 h mortality and the decrease of immunoreactive tyrosine hydroxylase and Bcl-2 (an anti-apoptotic gene product) in

the caudate putamen (He et al., 2004). Olanzapine also attenuates the okadaic acid-induced spatial memory impairment and hippocampal cell death (He et al., 2005b).

Quetiapine attenuated the memory impairment and the pathological changes in the APP/PS1 (He et al., 2007), reduced PC12 cell death and increased intracellular reactive oxygen species induced by A β (25-35) (Xu et al., 2008). These studies suggest that the anti-oxidant action of quetiapine may be useful in the treatment of AD. Results from our lab suggested that quetiapine has preventive effects on memory impairment and pathological changes if given prior to the onset of the memory impairment and amyloid plaque deposition in the AD model (He et al.). Further, quetiapine may have beneficial effects on memory impairment and pathological changes when administered after the onset of memory impairment and amyloid plaque formation in the transgenic mouse model of AD. The long-term effects of quetiapine in AD can be clarified by future studies where the chronic administration of quetiapine begins in the early stages of AD.

A recent study from our lab has shown that hippocampal neurogenesis was increased in the progressive stage of Alzheimer's disease phenotype in the APP/PS1 mouse (Yu et al., in press). Bromodeoxyuridine labeling supported by doublecortin (DCX) staining was used to detect proliferating hippocampal neurons in these mice. Compared with age-matched wild-type controls, 9-month old transgenic mice had memory impairment, numerous brain A β deposits and an increased number of proliferating hippocampal neurons. This study suggests that hippocampal neurogenesis may increase during the progression of AD in humans.

A number of studies have demonstrated the effectiveness of atypical antipsychotics, including quetiapine, in treating AD patients with BPSD such as psychoses, aggression and agitation (Caballero et al., 2006; Scharre & Chang, 2002; Street et al., 2000). Although quetiapine effectively alleviates psychoses in AD, its beneficial effects on cognition in AD remain inconclusive (Caballero et al.; Scharre and Chang). One possible reason for the uncertain effects of quetiapine on cognition is that the neuroprotective effects might be weakened or even lost with AD progression. Further studies are necessary to examine quetiapine's possible neuroprotective effects in AD.

On the other hand, despite adverse events such as increased risk of cerebrovascular events, sedation, increased BMI (Body Mass Index), and death from atypical antipsychotics in AD that Schneider et al. (2006) reported from their CATIE-AD study, quetiapine seemed most effective compared with other atypicals in specifically treating anxiety, psychoses, and cognitive disturbances. In 2006, a study by He, Xu et al. demonstrated the therapeutic effects of quetiapine on cognitive impairment and neurodegeneration. Quetiapine reduced the methamphetamine-induced memory impairment in the object recognition task (He, Yang et al., 2006). Also, He, Xu et al. (2005) showed that chronic administration of quetiapine reduced anxiety-like behaviours in the light/dark box and in the open field tests caused by the neurotoxic doses of dl-amphetamine in rats. In a previous study by Xu et al. (2002), quetiapine was found to prevent the brain-derived neurotrophic factor (BDNF) decrease induced by chronic stress, in the rat hippocampus. The current state of quetiapine's beneficial effects on anxiety-like behaviour remains unclear.

CHAPTER 2: METHODOLOGY

2.1. Experimental Design

2.1.1 General Hypothesis

The present study was designed to examine anxiety-like behaviours in the 12-month old APP/PS1 double transgenic mice in comparison to non-transgenic controls, and to investigate the effects of quetiapine on these behaviours. In addition, this study measured BDNF levels in the amygdala. Two hypotheses will be addressed: (1) Quetiapine will reduce memory impairment, and anxiety-like behaviours; (2) Quetiapine will alleviate the BDNF decrease in the amygdala and hippocampus, and will reduce the plaque load in the hippocampus and cortex.

This study attempts to clarify the relationship between A β plaque load, memory impairment, and anxiety in a mouse model of AD. The expected findings are important because they may highlight the pathogenesis involved in AD as well as potential treatments for its symptoms. This study will not only contribute to the understanding of the relationship between BPSD and memory deficits in AD. It also has implications for early diagnoses and early intervention in AD patients, particularly because the animals in the current study begin to receive treatment before the onset of symptoms. Lastly, the present study contributes to the field of AD research by addressing the underlying neurobiological effects of quetiapine on anxiety-like behaviours and BDNF in AD.

2.1.2 Study Design Analysis

This study was part of a larger study conducted in the laboratory. The experiments included in this thesis used a 2 (transgene versus non-transgene (control)) by 2 (quetiapine treated versus non-quetiapine treated (water)) between subjects design. Female and male animals that were control non-transgenic or transgenic were randomly assigned to either of 2 drug treatment groups, water or 5 mg/kg/day quetiapine. Animals received quetiapine treatment for 7 or 10 months beginning at the age of 2 months old. The study had 2 components: animals were assessed on 2 measures of learning and memory and plaque load at the age of 9 months. Anxiety-

like behaviour and BDNF were examined in other mice at the age of 12 months. A previous experiment in the laboratory found that anxiety was not as profoundly displayed at the age of 9 months, so 12 month old mice were selected for the 2nd component of the study.

Animals were assessed in 2 measures of anxiety in the ETM, escape and avoidance, and the brains were assessed for BDNF immunohistochemistry. Another group of animals were examined on 2 measures of learning and memory, the Y-maze and the Morris Water Maze and the brains were assessed for plaque formation using Congo Red staining.

For the learning and memory portion of the experiments and the corresponding plaque assessment, a 2.5 mg/kg/day quetiapine group was included because this was done early in the experiment series. The 2.5 mg/kg/day group was subsequently excluded from the remaining studies because it was not different from the 5 mg/kg/day group.

2.1.4 Animals

All animal care and procedures with animals were performed in accordance with the guidelines established by the Canadian Council on Animal Care and were approved by the Animal Care Committee of the University of Saskatchewan. The APP/PS1 were generated from matings between APPK670N/M671L (Hsiao et al., 1996) and PS1M146L (Duff et al., 1996) (Figure 2). This model is recognized for exhibiting significantly increased A β 42 and A β 40 levels and accelerated deposition of A β plaques (He et al., 2007). In total, 118 female and 118 male mice were used in the present study (Table 1). The mice were individually implanted with a subcutaneous micro identification chip (BioMedic Data Systems Inc., Seaford, DE). Due to aggressive behaviour displayed between the male transgenic mice, all males were individually housed, while 4 to 5 female mice were housed in group cages. All mice received free access to food and water under controlled lab conditions (a 12:12 h light/dark cycle room temperature, 20 \pm 1 °C), and were acclimatized for one week before the experiment.

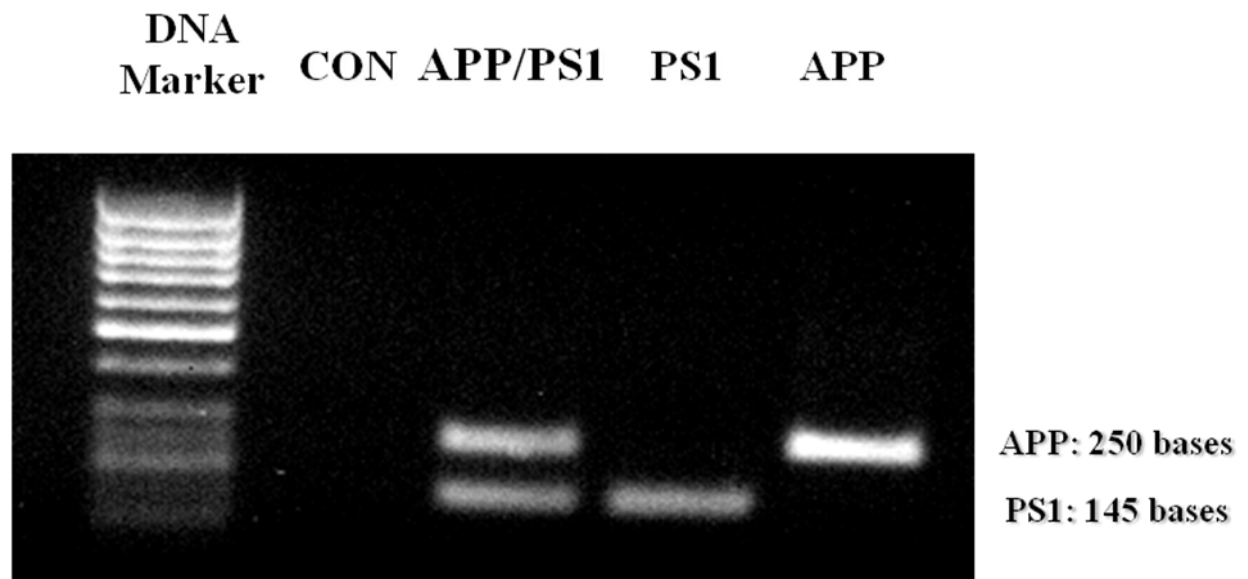

Figure 3. PCR photographic representation of complementary DNA obtained from double transgenic APP/PS1 mouse carrier and single transgenic PS1 or APP mice carriers.

Con: Control or non-transgenic; APP/PS1 Tg2576: Amyloid Precursor Protein and Presenilin 1 M146L; APP: Amyloid Precursor Protein; PS1: Presenilin 1.

Table 1

Number of Mice in Each Group.

	Con	Q2.5	Q5	Tg	Tg+Q2.5	Tg+Q5
9 month						
Male	13	8	14	14	8	16
Female	8	9	7	8	7	9
12 month						
Male	13	-	13	10	-	9
Female	21	-	22	11	-	16

2.1.3 Drug Treatment

Quetiapine was provided by AstraZeneca Pharmaceuticals (Macclesfield, UK). The mice were treated with quetiapine (5 mg/kg/day) orally in double distilled drinking water (2 mg/100 mL water) for 10 months beginning at 2 months of age. The between group design was comprised of four groups: non-transgenic+water (Con), non-transgenic+quetiapine 5 mg/kg/day (Q5), transgenic+water (Tg), and transgenic+quetiapine (Tg+Q5). For selected experiments, an additional group of animals received 2.5 mg/kg/day of quetiapine for 7 months. In preliminary studies, there was no significant difference between the groups regarding the amount of water consumed per day. On average, a 30 g mouse drank 7.5 mL a day.

2.2. Behavioural Testing

Cognitive behaviours in the Y-maze and the Water-Maze were tested at 9 months of age and anxiety-like behaviours were tested in the ETM at 12 months of age.

2.2.1 Anxiety: Elevated T-Maze

The ETM (Viana, Tomaz & Graeff, 1994) is a T shaped wooden apparatus composed of 3 arms with equal dimensions (50 × 12 cm) elevated at 50 cm above the floor (Figure 3). One of the arms is surrounded by three 20 cm high walls. To reduce the risk of mice falling off, the 2 open arms are lined with a transparent plastic rim 5 mm high. To reduce additional stress in the testing environment, the experimenter observed and measured each mouse's behaviour from outside of the procedural room using a camcorder that was suspended above the maze.

Avoidance in the ETM is related to conditioned anxiety or GAD, and the one-way escape in the ETM is related to unconditioned anxiety or PD. At twenty-four hours preceding the behavioural testing, the mouse was habituated for 30 min to one of the open arms of the T-maze. On trial 1, the time taken by the mouse to leave the closed arm with all four paws was recorded as the baseline latency. The same measurement was repeated in two avoidance trials, avoidance 1 and avoidance 2, at 30 sec intertrial intervals. After the avoidance phase the mouse was placed at

the end of the open arm and the time to leave this arm with four paws was recorded as escape latency 1, 2 and 3, at a 30 sec intertrial interval. For each trial there was a cut off time of 300 sec (5 min), (Figure 4). For the ETM we used the 12 month old female (n=70) and male (n=45) mice. Table 1 illustrates the number of mice per group at 12 months of age.

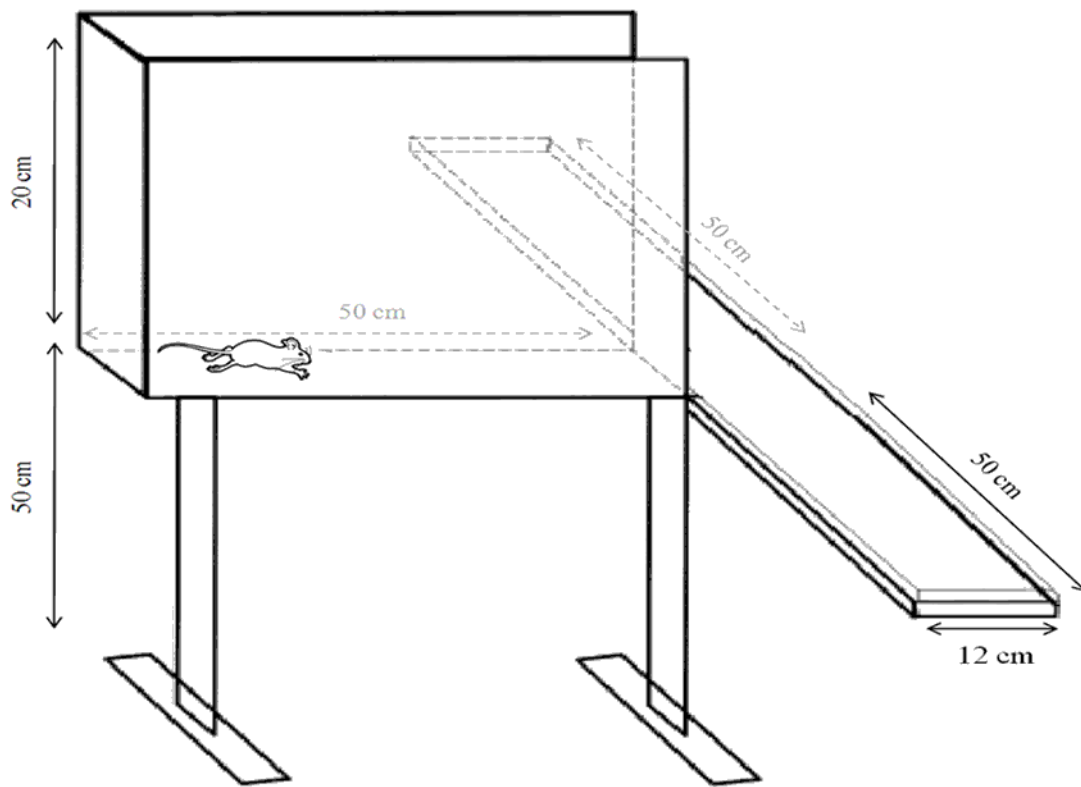

(adapted from Zangrossi & Graeff, 1996)

Figure 4. Schematic representation of the elevated T-maze (ETM).

The ETM is a T shaped wooden apparatus composed of 3 arms of equal dimensions (50×12 cm) elevated at 50 cm above the floor. One of the arms is enclosed by walls (20cm), and is perpendicular to the two arms. To reduce the mice from falling off, the 2 open arms are lined with a transparent plastic rim 5 mm high.

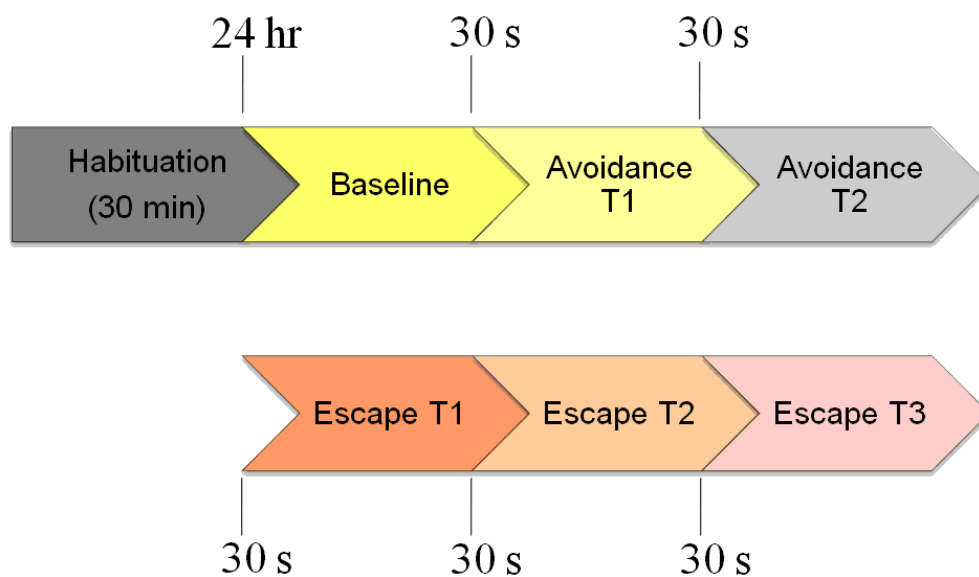

Cut off time = 300 s

Figure 5. Model of the elevated T-maze (ETM) behavioural procedure.

Twenty-four hours preceding the behavioural testing the mice were habituated for 30 min to one of the open arms in the T-maze. The time taken by the mouse to leave the closed arm on trial 1 with all four paws was recorded as the baseline latency. The same measurement was repeated in two avoidance trials, Avoidance 1 and Avoidance 2, at 30 sec intertrial intervals. After a 30 sec intertrial interval followed the one-way escape trials. The mouse was placed at the end of the open arm and the time to leave this arm with four paws was recorded as escape 1, 2 and 3. For each trial there was a cut off time of 300 sec (5 min).

2.2.2 Y-Maze Test

Spatial working memory performance was assessed by a single trial recording spontaneous alternation behaviour in a 3 arm Y-maze (He et al., 2007). The Y-maze is based on the innate tendency of rodents to explore a novel environment, and measures spatial recognition. The memory performance on the Y-maze is often associated with the condition of the hippocampus and the effects of different treatments on the hippocampus and memory. The maze is made of painted black wood and the arms of the Y-maze are 35 cm long, 25 cm high and 10 cm wide and are positioned at an equal angle from each other. The mice were individually placed at the end of one arm and allowed to move freely through the maze during an 8-min session. The ability to alternate requires that the mice know which arm they have already visited. The sequence of arm entries was recorded visually by an investigator. Spontaneous alternation behaviour was defined as the entry into all three arms on consecutive choices in overlapping triplet sets. The percentage of spontaneous alternation behaviour was calculated as the ratio of actual to possible alternations (defined as the total number of arm entries minus 2) multiplied by 100. For the Y-maze we used the 9 month old female (n=48) and male (n=73) mice. Please refer to table 1 for the specific numbers of mice in each group at 9 months of age.

2.2.3 Water Maze Test

Spatial memory acquisition and retention by the mice were assessed with the Morris water maze (Morris, 1984). The Morris water maze is based on the innate tendency of rodents to escape a water filled area. It was developed by Richard Morris in (1984) and is commonly used today to explore the role of the hippocampus in the formation or acquisition and retention of spatial memory. This test was conducted on the day following the Y-maze test. The water maze consisted of a plastic pool (120 cm in diameter). An overhead video camera coupled to a computer with an image analyzer [Chromotrack (San Diego Instruments, San Diego, CA); EthoVision (Noldus Information Technology, Sterling, VA)] was used to track the movement of the mice (He et al., 2005a). In the acquisition (hidden-platform) phase, a hidden clear Plexiglas® platform (10 cm in diameter) was kept constant in the middle of one particular quadrant throughout training. The training consisted of 4 blocks of trials (4 trials/block, with a 5-min

intertrial interval). Each trial lasted until the mouse climbed onto the hidden platform or until the cut-off time of 60 seconds was elapsed. The time to find and climb on the platform was recorded as the escape latency. The retention (probe) test was carried out 24 hrs after the last training trial with the platform removed, each mouse was put into the pool for 60 sec, and the percentage (%) of time spent in each of the 4 quadrants was measured. For the Water maze we used the 9 month old female (n=48) and male (n=73) mice. Please refer to table 1 for the specific numbers of mice in each group at 9 months of age.

2.3 Tissue Processing and Histology

Following the behaviour tests, the mice were deeply anesthetized with Nembutal (50 mg/kg, i.p.), and perfused through the ascending aorta with 50 mL of 0.1 M phosphate-buffered saline (PBS, PH 7.4). The left hemisphere was postfixed in 4% paraformaldehyde for 24 hr followed by cryoprotection in 30% sucrose for 3 days. The left hemispheres of 12-month old mice were cut into 30- μ m thick coronal sections, and a set of free-floating sections were used for BDNF immuno-histochemistry. The left hemispheres of 9-month old mice were cut into 30- μ m thick horizontal sections, and were used for Congo Red staining. The right hemispheres were used for other experiments.

2.3.1 BDNF Level Measurements

For BDNF immunohistochemistry, coronal sections were incubated with rabbit polyclonal anti-BDNF antibody (1:1000; Santa Cruz Biotechnology, Santa Cruz, CA) for 12 h at 4 $^{\circ}$ C. The sections were then washed with phosphate-buffer containing 0.3% Triton X-100 and incubated with biotinylated goat anti-rabbit antibody (1:200; Biosource, Carlsbad, CA) at room temperature for 2 h. Finally, all sections were washed and processed with avidin-biotinylated horseradish peroxidase complex (Vector ABC kit, Vector Laboratories, Burlingame, CA), and the reaction was visualized using diaminobenzidine. The number of BDNF-stained positive cells in the BLA and hippocampus were counted manually under an Olympus BH2-RFCA microscope at 100x magnification in the 10 month old female mice (n=38). The female mice were divided into four groups composed of 10 wild-type, 9 wild-type quetiapine-treated, 9 transgenic, 9

transgenic quetiapine-treated. For convenience the BLA was measured in 3 of its distinct regions of equal dimensions of 361 mm², they can be defined as the bottom left and right, and top center regions of the BLA. The overall average of the 3 separate regions as a whole was compared. For the hippocampus we counted the total number of positive cells in the CA1, CA3, and DG areas, and compared the overall average of these 3 regions. All micrographs of representative sections were photographed using an Axio-Imager A1, camera Axiocam, and the software Axio-Vision version 4 for image acquisition (all from Carl Zeiss, Jena, Germany).

2.3.2 Staining and Quantification of Amyloid Deposits

Horizontal sections were stained for amyloid deposits with Congo Red solution (Congo Red kit, Sigma–Aldrich, St. Louis, MI) after counterstaining with Mayer’s hematoxylin solution according to the manufacturer’s protocol. The number of Congo Red-stained amyloid plaques in the cortex and the hippocampus were counted under an Olympus BH2-RFCA microscope at 100x magnification in the 9 month-old mice (He et al., 2007). The total number [$<25\ \mu\text{m}$ (small), $25\ \text{to}\ 50\ \mu\text{m}$ (medium), and $>50\ \mu\text{m}$ (large) in diameter] of amyloid plaques in the cortex and the hippocampus (three horizontal sections at levels of 2.16, 2.34, and 2.52mm ventral to bregma) were counted manually. The size of the total counted area was collected using a Olympus BH2-RFCA microscope fitted with a Spot-RT digital camera (Diagnostic Instruments, Sterling Heights, MI), and analyzed using Image-Pro Plus software (Media Cybernetics, Silver Spring, MD). Plaques for which the intensity was not sufficiently above the background to meet the proper threshold were not considered. Plaque counting was performed by an investigator who was blind to group membership. The plaque number is reported as the total number of plaques counted per 10mm² area of the cortex or hippocampus. For the Congo Red staining we used the 9 month old female (n=48) and male (n=73) mice. Please refer to table 1 for the specific numbers of mice in each group at 9 months of age.

Plaque detection in the 12 month-old mice was also investigated. Micrographs of representative sections for the plaque detection of the 12 months old mice were photographed using an Axio-Imager A1, camera Axiocam, and the software Axio-Vision version 4 for image acquisition (all from Carl Zeiss, Jena, Germany).

2.4 Statistical Analysis

The first hypothesis, which addressed the effects of quetiapine on memory in the Y-maze and water maze, and anxiety-like behaviours in the ETM, was analyzed using one-way analysis of variance (ANOVA) to determine the statistical difference between levels of anxiety among the non-transgenic and the APP/PS1 mice. To test the first hypothesis, an α level was set at 0.05. For the behavioural measures, one way ANOVAs were conducted to compare genotype (non-transgenic and transgenic) within each level of treatment factor (quetiapine: 0, 2.5 and 5 mg/kg/day) for females. Results of the preliminary analysis showed a high variability in treatment effect among the male mice, implying that sex was not a necessary factor to study as an interaction or covariate. Therefore the female mice were used in this study.

To analyze the second hypothesis, which addressed the effects of quetiapine on BDNF levels in the amygdala and hippocampus, and on the plaque load in the hippocampus and cortex, the significant differences were determined by two-way ANOVA. This analysis was used to observe whether there would be an interaction between genotype (non-transgenic and transgenic) and drug (quetiapine: 0, 2.5 and 5 mg/kg/day). A p value of less than 0.05 was regarded as statistically significant. Newman-Keuls *posthoc* test for multiple comparisons were conducted. A two-tailed t -test for independent samples was used for two-group comparisons. All results were expressed as means \pm S.E.M.

CHAPTER 3: RESULTS

3.1. Conditioned Anxiety and Unconditioned Anxiety in the ETM

3.1.1. Avoidance

A two-way analysis of variance (ANOVA) showed that there was an interaction of treatment group by genotype that approached significance, $F(1,54) = 3.923$, $p = 0.053$, for female mice. Simple effects tests (Figure 5) comparing transgenic and control groups within water treatment revealed that transgenic mice had significantly lower latencies, $t(23) = 3.839$, $p = 0.0012$, compared to controls when receiving water. The t-test, $t(22) = -3.602$, $p = 0.0017$, revealed that transgenic mice treated with quetiapine had significantly higher latency in the avoidance task than transgenic mice treated with water. Transgenic female mice treated with quetiapine were similar to controls and controls treated with quetiapine (Figure 5). There was no significant interaction or significant main effect in avoidance latency 1. As previously mentioned male mice displayed high variability within the groups and failed to show the effect of treatment.

3.1.2. Escape

A 2 (genotype) by 2 (treatment) ANOVA of female mice revealed a nonsignificant interaction, $F(1, 54) = 0.19448$, $p = 0.661$ between genotype and treatment group in the escape 3 (Figure 8). A main effect of genotype was found and transgenic mice had significantly lower escape latencies than control non-transgenic mice, $F(1,54) = 20.09$, $p < 0.001$ (Figure 6). There was no main effect of drug treatment, $F(1, 54) = 0.919$, $p = 0.3418$. In the escape latency 1 and 2 trials, the interaction and main effects were non-significant.

3.2. BDNF Levels in the Basolateral Amygdala and the Hippocampus

3.2.1. Basolateral Amygdala

Figure 7 shows the procedure for counting cells. A non-significant interaction of genotype (transgenic versus non-transgenic) by treatment (quetiapine, water) was found, $F(1,36) = 1.3902$, $p = 0.2468$ (Figure 8). A significant main effect of genotype was found, $F(1,33) = 24.6851$, $p = 0.0001$. The transgenic mice had significantly lower BDNF ($M = 102.5432$) in the BLA compared to control non-transgenic ($M = 121.5225$). A significant main effect of treatment, $F(1,36) = 9.9124$, $p = 0.0035$, revealed that quetiapine-treated transgenic mice had significantly higher BDNF expression in the BLA compared with the water-treated transgenic mice. Figures 7 and 9 illustrate representative photomicrographs of BDNF immunostaining in the BLA of 12-month old female mice.

3.2.2. Hippocampus

A non-significant interaction of genotype (transgene versus non-transgene) by treatment (quetiapine versus water) was found, $F(1,36) = 1.4962$, $p = 0.2299$ (Figure 12). A 2 (genotype) by 2 (treatment) ANOVA revealed a significant main effect of genotype $F(1,33) = 4.1029$, $p = 0.051$, whereby transgenic mice ($M = 1069.6358$) had significantly lower BDNF compared to control non-transgenic ($M = 1158.6488$) in females. A significant main effect of treatment, $F(1,33) = 11.6798$, $p = 0.0017$, revealed that quetiapine treated transgenic female mice ($M = 1189.2346$) had significantly higher BDNF in the hippocampus (CA1, 2, 3 and DG) compared to water ($M = 1039.05$) treated female transgenic mice. Figure 10 and 12 illustrate representative photomicrographs of BDNF immunostaining in the hippocampus of 12-month old female mice.

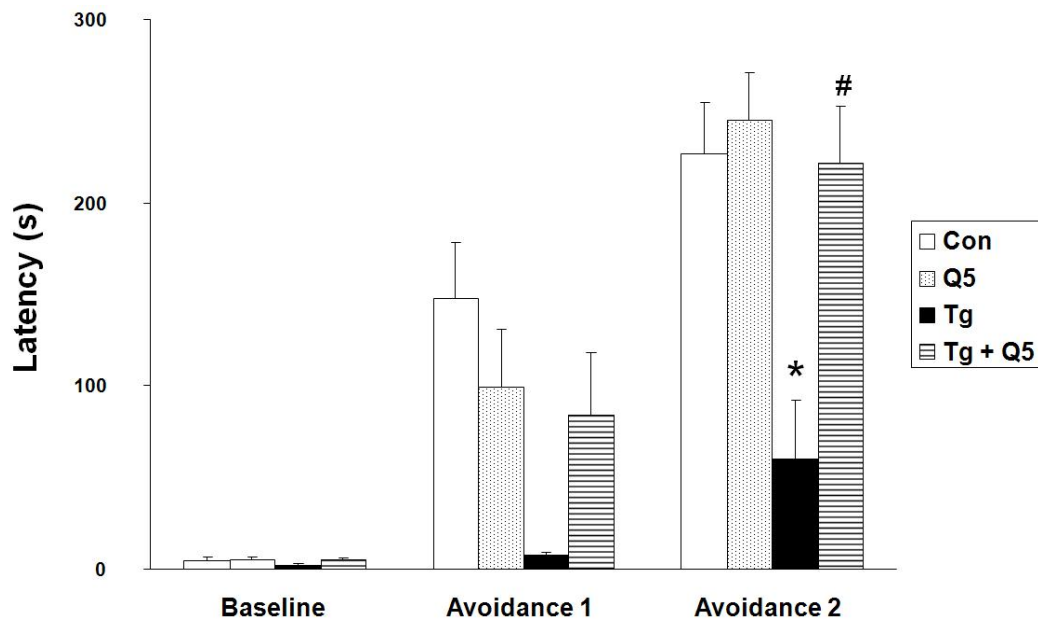

Figure 6. Avoidance in the elevated T-maze in female mice.

The effect of genotype (transgene versus control) and treatment group (quetiapine versus water) on inhibitory avoidances measured in 3 trials, Baseline, Avoidance 1, and Avoidance 2 in the elevated T-maze: Con: Control (non-transgenic); Q5: quetiapine 5 mg/Kg/day in non-transgenic; Tg: APP/PS1 double transgenic in water treatment group; Tg+Q5: APP/PS1 double transgenic in quetiapine treated group. Quetiapine was administered in drinking water from the age of 2 months for 10 months. Results are expressed as means±S.E.M. $n = 10-18$ in each group. * $p < 0.05$ vs. Con; # $p < 0.05$ vs. Tg.

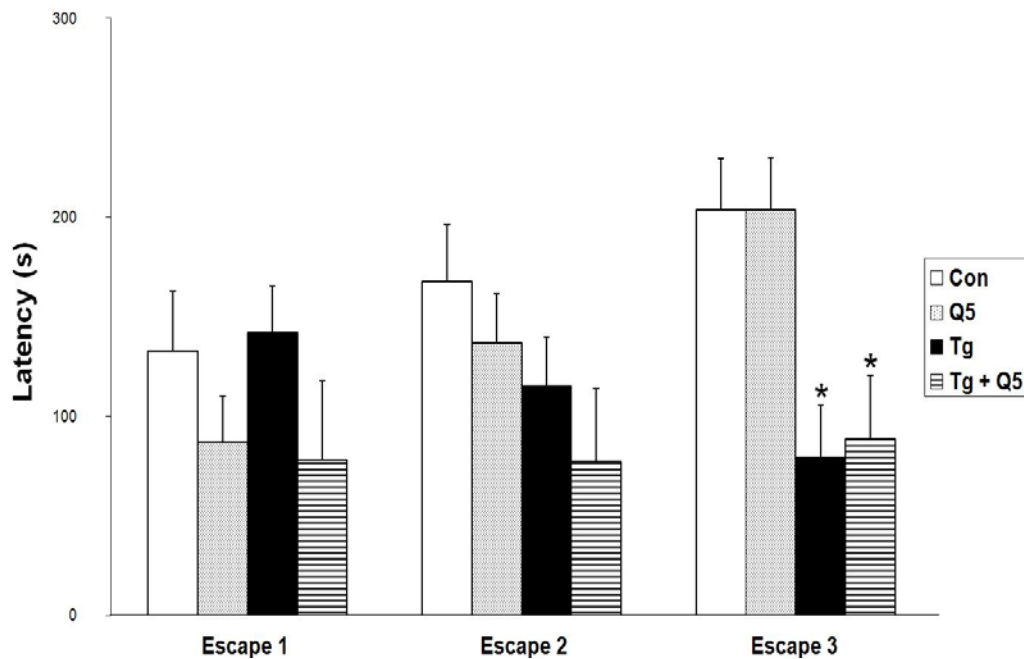

Figure 7. Escape in the elevated T-maze in female mice.

The effect of genotype (transgene versus control) and treatment group (quetiapine versus water) on one-way escape measured in 3 trials, Escape 1, Escape 2, and Escape 3 in the elevated T-maze: Con: Control (non-transgenic); Q5: quetiapine 5 mg/Kg/day in non-transgenic; Tg: APP/PS1 double transgenic in water treatment group; Tg+Q5: APP/PS1 double transgenic in quetiapine treated group. Quetiapine was administered in drinking water from the age of 2 months for 10 months. Results are expressed as means±S.E.M. $n = 10-18$ in each group. * $p < 0.05$ vs. Con.

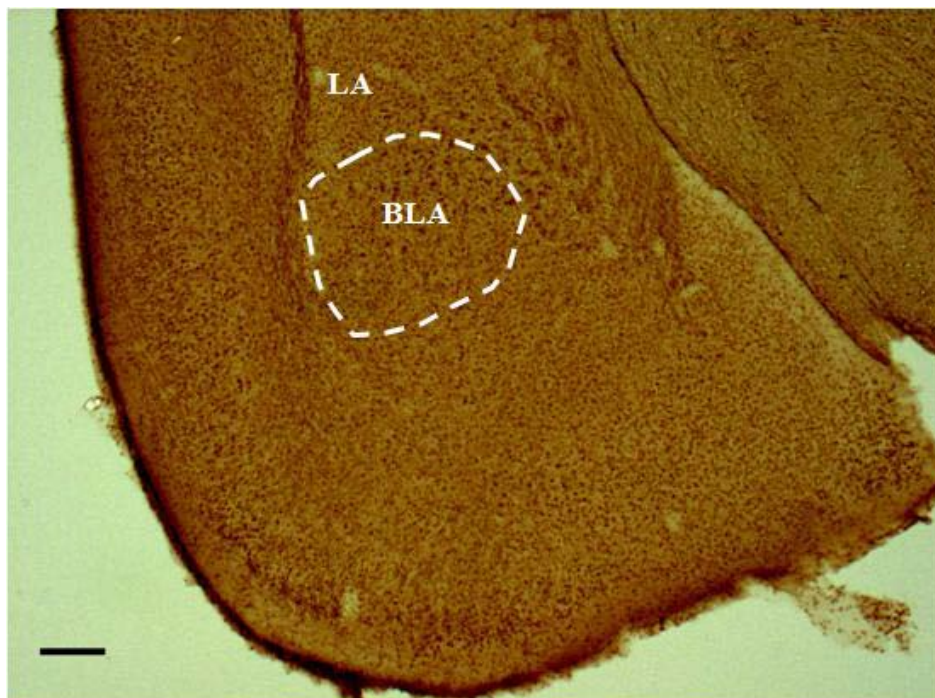

Figure 8. Representative photomicrograph of BDNF immunostaining in the amygdala of a 12 month old female mice treated with quetiapine for 10 months.

The BDNF positive cells were counted in the highlighted BLA (Basolateral Amygdala) located just beside the LA (Lateral Amygdala). Scale bar = 200 μ m.

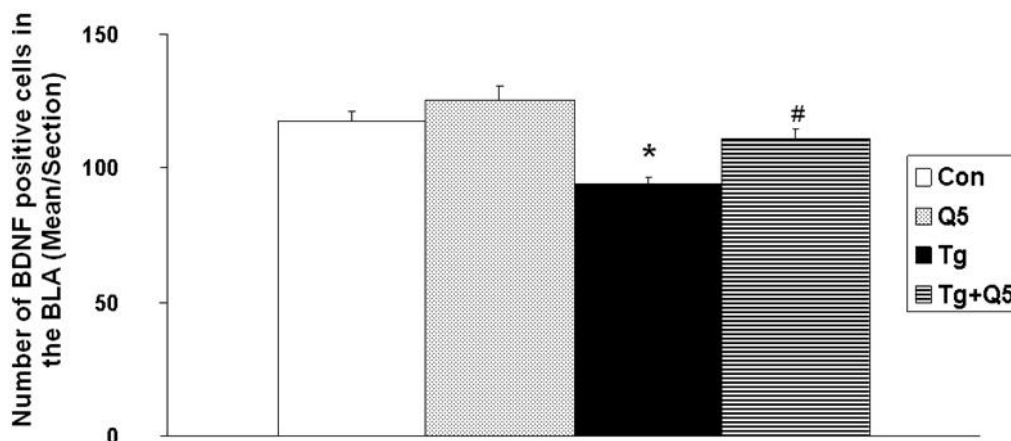

Figure 9. Quantitative analysis of BDNF-positive cells in the BLA (Basolateral Amygdala) of 12-month old female mice.

Effects of genotype (transgene versus control) and treatment group (quetiapine versus water) on the BDNF-positive cells in the BLA (Basolateral Amygdala) of 12-month old female mice: Con: Control (non-transgenic); Q5: quetiapine 5 mg/Kg/day in non-transgenic; Tg: APP/PS1 double transgenic in water treatment group; Tg+Q5: APP/PS1 double transgenic in quetiapine (5mg/kg/day) treated group. Quetiapine was administered in drinking water from the age of 2 months. Results are expressed as means±S.E.M. $n = 9-10$ in each group. * $p < 0.05$ vs. Con; # $p < 0.05$ vs. Tg.

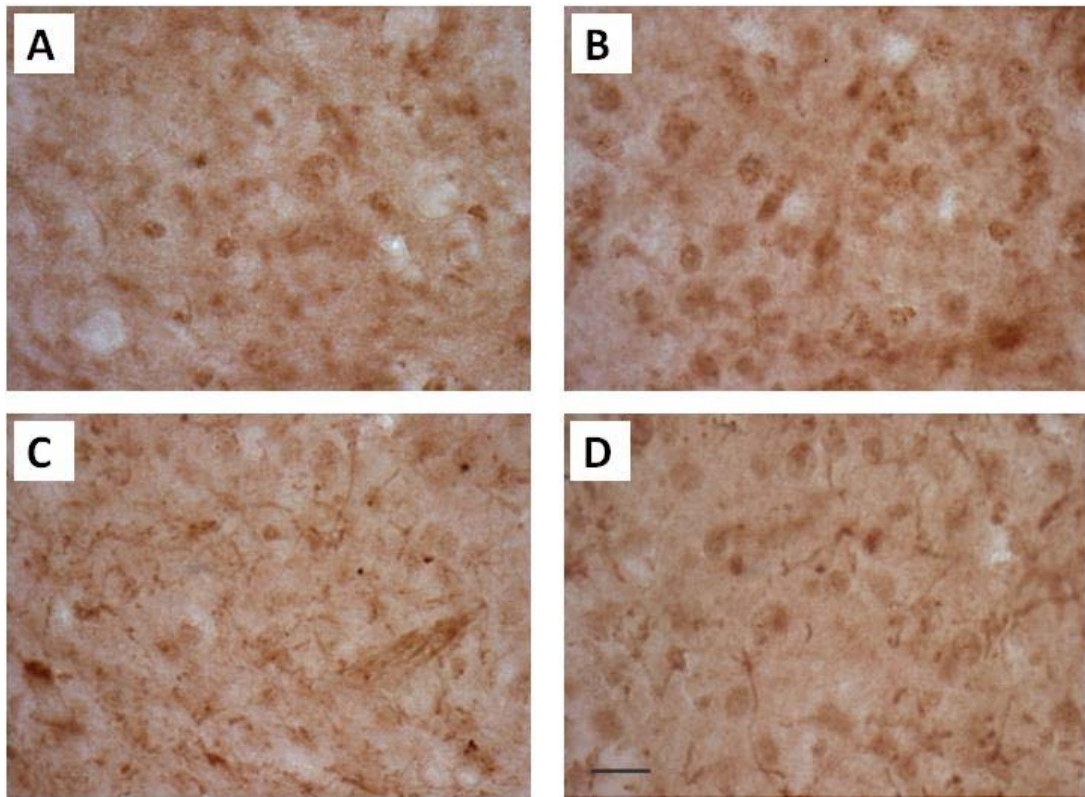

Figure 10. Representative photomicrographs of BDNF immunostaining in the BLA (Basolateral amygdala) in 12-month old female mice.

Control (non-transgenic) (A); Q5: quetiapine 5 mg/Kg/day in non-transgenic (B); Tg: APP/PS1 double transgenic in water treatment group (C); Tg+Q5: APP/PS1 double transgenic in quetiapine (5mg/kg/day) treated group (D). Quetiapine was administered in drinking water from the age of 2 months; Scale bar = 20 μ m.

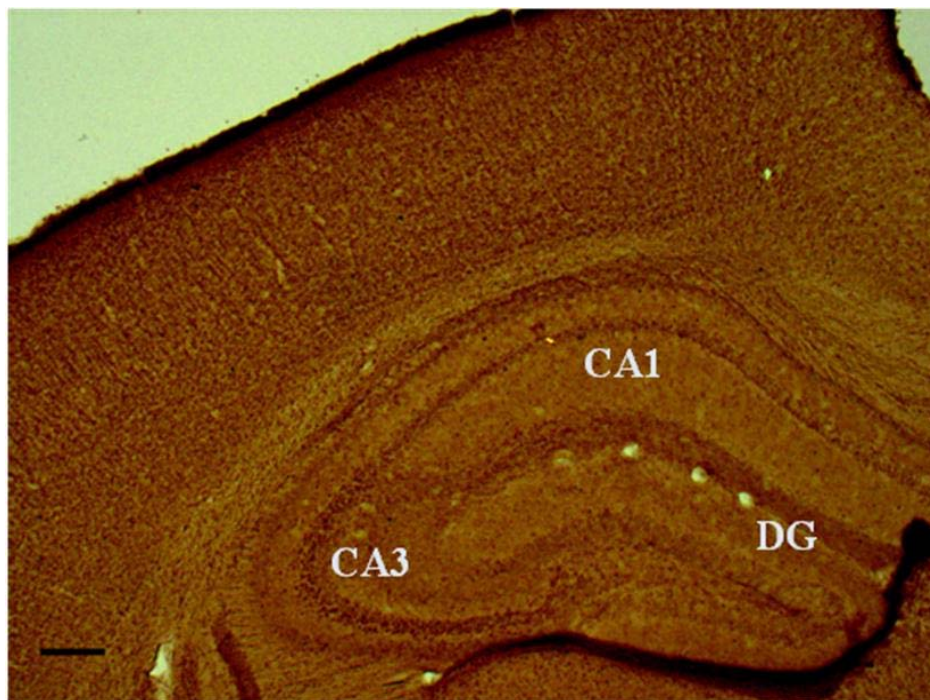

Figure 11. Representative photomicrograph of BDNF immunostaining in the hippocampus of a 12-month old female mice treated with quetiapine for 10 months.

The BDNF positive cells were counted in the CA1 (Cornu Ammonis 1), CA3 (Cornu Ammonis 3) and DG (Dentate Gyrus) regions of the hippocampus. Scale bar = 200 μ m.

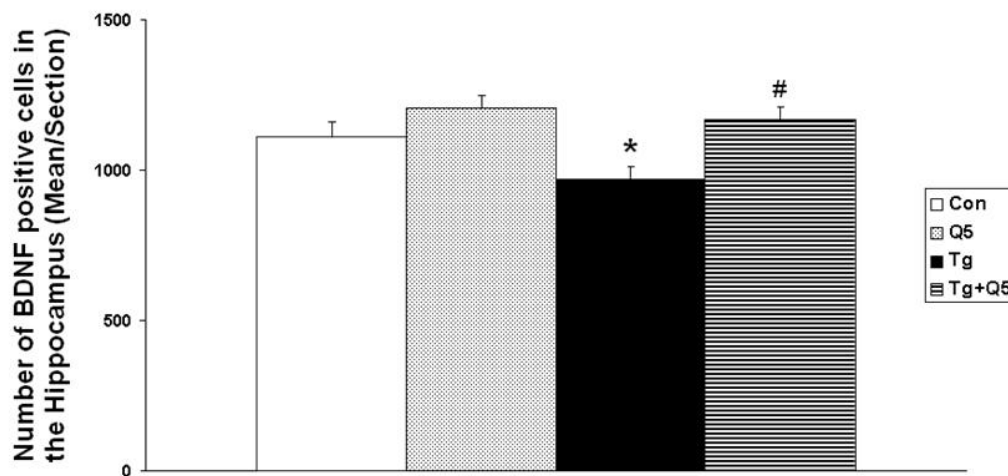

Figure 12. Quantitative analysis of BDNF-positive cells in the Hippocampus (CA1, CA2, CA3, DG) of 12-month old female mice.

Effects of genotype (transgene versus control) and treatment group (quetiapine versus water) on the BDNF-positive cells in the Hippocampus (CA1, CA2, CA3, DG) of 12-month old female mice: Con: Control (non-transgenic); Q5: quetiapine 5 mg/Kg/day in non-transgenic; Tg: APP/PS1 double transgenic in water treatment group; Tg+Q5: APP/PS1 double transgenic in quetiapine (5mg/kg/day) treated group. Quetiapine was administered in drinking water from the age of 2 months. Results are expressed as means±S.E.M. $n = 9-10$ in each group. * $p < 0.05$ vs. Con; # $p < 0.05$ vs. Tg.

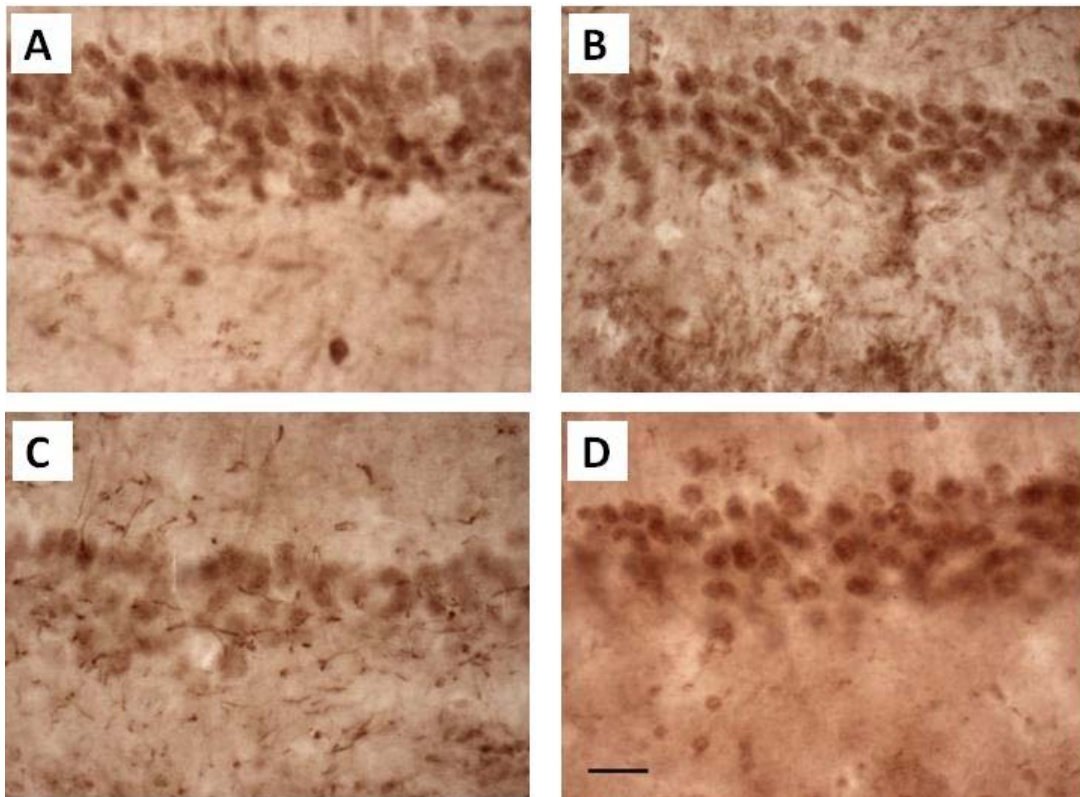

Figure 13. Representative photomicrographs of BDNF immunostaining in CA1 pyramidal cell layers of the hippocampus in 12-month old female mice.

Control (non-transgenic) (A); Q5: quetiapine 5 mg/Kg/day in non-transgenic (B); Tg: APP/PS1 double transgenic in water treatment group (C); Tg+Q5: APP/PS1 double transgenic in quetiapine (5mg/kg/day) treated group (D). Quetiapine was administered in drinking water from the age of 2 months; Scale bar = 20 μ m.

3.3. β -Amyloid Plaque Formation in APP/PS1 Mice Treated With Quetiapine

A β deposits were not found in the 9-month-old non-transgenic mice. The number of Congo Red-positive plaques in the transgenic mice by treatment group are shown in Figure 13A (cortex) and 13B (hippocampus). One-way ANOVAs showed a significantly greater number of large plaques in the cortex of transgenic female and male mice, $F(2, 59) = 5.71, p = 0.0054$ and hippocampus, $F(2, 59) = 4.71, p = 0.013$, medium plaques in the cortex, $F(2, 59) = 10.68, p = 0.0001$ and hippocampus, $F(2, 59) = 7.54, p = 0.0012$, small plaques in the cortex, $F(2, 59) = 12.43, p < 0.0001$ and hippocampus, $F(2, 59) = 9.62, p = 0.0002$, and total plaques in the cortex, $F(2,59) = 15.47, p < 0.0001$, and hippocampus, $F(2, 59) = 10.69, p = 0.0001$, of 9-month-old transgenic mice. Figure 13 illustrates representative photomicrographs of Congo Red staining showing A β plaques in the cortex of 9-month old APP-PS1 transgenic mice. Plaque deposition was also found in the hippocampus (Figure 15B) and BLA (Figure 15D) of 12-month transgenic mice. There were no detectable plaques in the 12-month non-transgenic mice (Figure 15A, C).

3.4. Y-Maze Spatial Working Memory in APP/PS1 Mice Compared With Control

In the Y-maze, in which there were 2 levels of drug (0, 2.5, 5 mg/kg/day), 9-month females and males were used. The interaction between drug treatment and genotype approached significance, $F(1, 117) = 29741, p = 0.055$ (Figure 16A). A test of simple effects was conducted, with an alpha set at 0.01. Newman-Keuls post hoc test revealed lower alternation percentage in transgenic mice, $F(1,112) = 24.1567, p < 0.01$, compared with the control (non-transgenic treated with water). However, higher alternation was found in the transgenic mice treated with quetiapine 2.5 mg/kg/day, $F(1, 112) = 12.53054, p < 0.01$, compared with water treated transgenic mice. Higher alternation was also found in the transgenic mice treated with the higher dose of quetiapine (5 mg/kg/day), compared with transgenic mice treated with water, $F(1, 112) = 25.34359, p < 0.01$. No significant difference was observed for the transgenic mice treated with quetiapine 2.5 mg/kg/day, compared with the APP/PS1 treated with 5 mg/kg/day, $F(1, 112) = .68738, p > 0.05$. Overall, transgenic mice treated with water resulted in a lower percentage of alternation in comparison with those APP/PS1 treated with quetiapine 2.5 and 5 mg/kg/day. APP/PS1 receiving quetiapine 5 mg/kg/day and 2.5 mg/kg/day was no different than controls (p

> 0.05). For the 9-month-old mice (Figure 16A), two-way ANOVA showed that genotype 9-months, $F(1, 112) = 24.09$, $p < 0.0001$, and quetiapine 9-month, $F(2, 112) = 10.60$, $p < 0.0001$, had a significant effect on the alternation performance. There was no difference in the number of total arm entries among the groups of 9-month-old mice (Figure 16B).

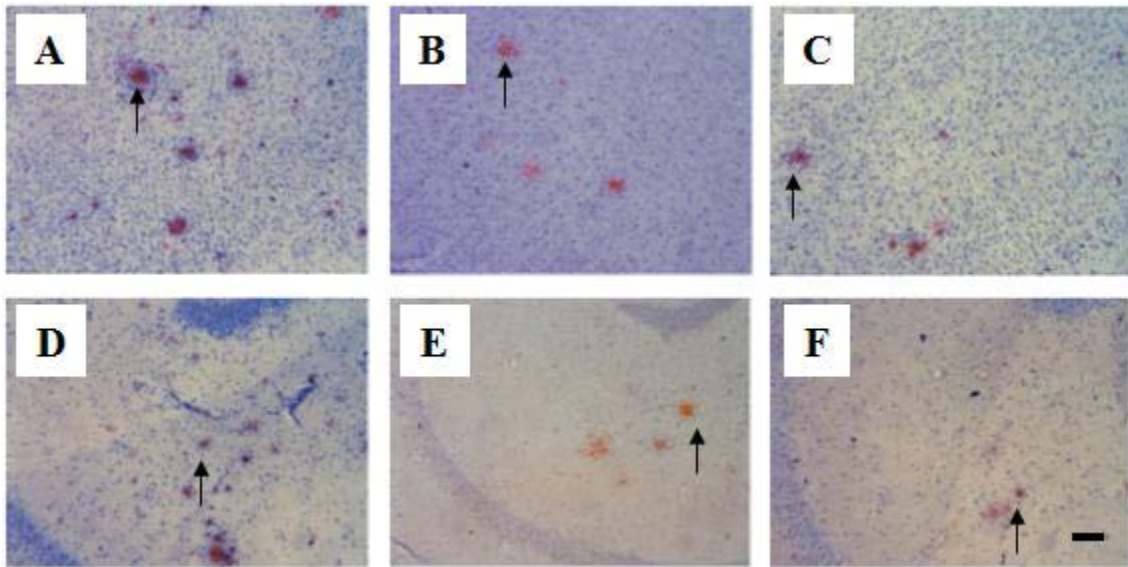

Figure 14. Representative photomicrographs of Congo Red staining showing A β plaques in the cortex and hippocampus of 9-month of age APP/PS1 mice.

A β plaques in the cortex of 9-month transgenic (A), transgenic + quetiapine 2.5 mg/kg/day (B), and transgenic + quetiapine 5 mg/kg/day (C) mice; in the hippocampus of 9-month transgenic (D), transgenic + quetiapine 2.5 mg/kg/day (E), and transgenic + quetiapine 5 mg/kg/day (F) mice. The arrows indicate the positive A β plaques of Congo Red staining. Scale bar = 90 μ m.

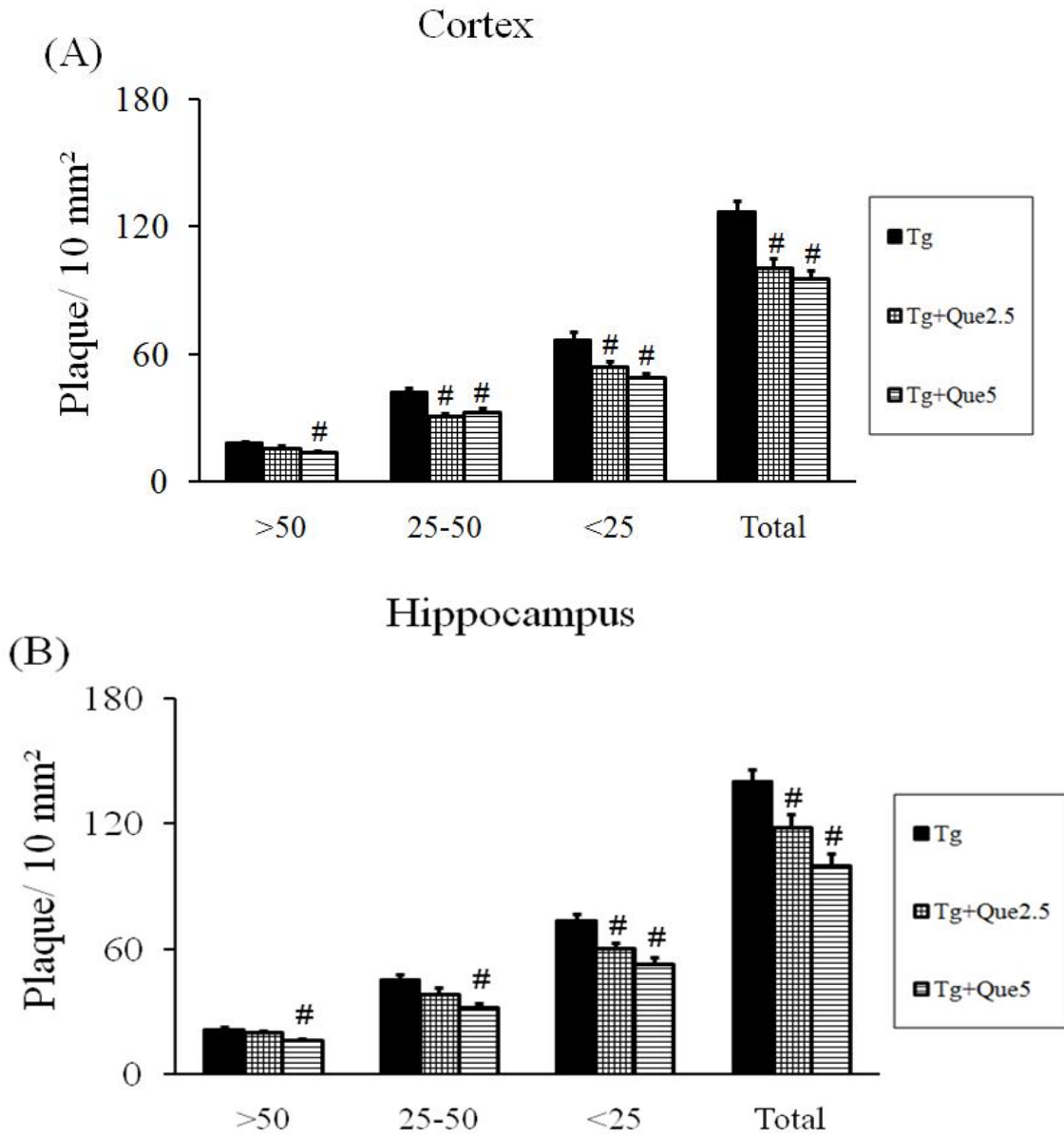

Figure 15. Quantitative analysis of plaques by Congo Red staining in the cortex and hippocampus.

Quantitative analysis of Congo Red staining showing chronic administration of quetiapine on the number of large (>50 μm in diameter), medium (25–50 μm in diameter), small (<25 μm in diameter), and total (large + medium + small) plaques (per mm^2), in the cortex (A) and hippocampus (B) of 9-month old male and female transgenic mice. Tg: APP/PS1 transgenic in water treatment group; Tg+Q2.5: APP/PS1 transgenic in quetiapine 2.5mg/kg/day treated group; Tg+Q5: APP/PS1 transgenic in quetiapine 5mg/kg/day treated group. Quetiapine was

administered in drinking water from the age of 2 months. Results are expressed as means±S.E.M. $n = 4-16$ in each group. Con; # $p < 0.05$ vs. Tg.

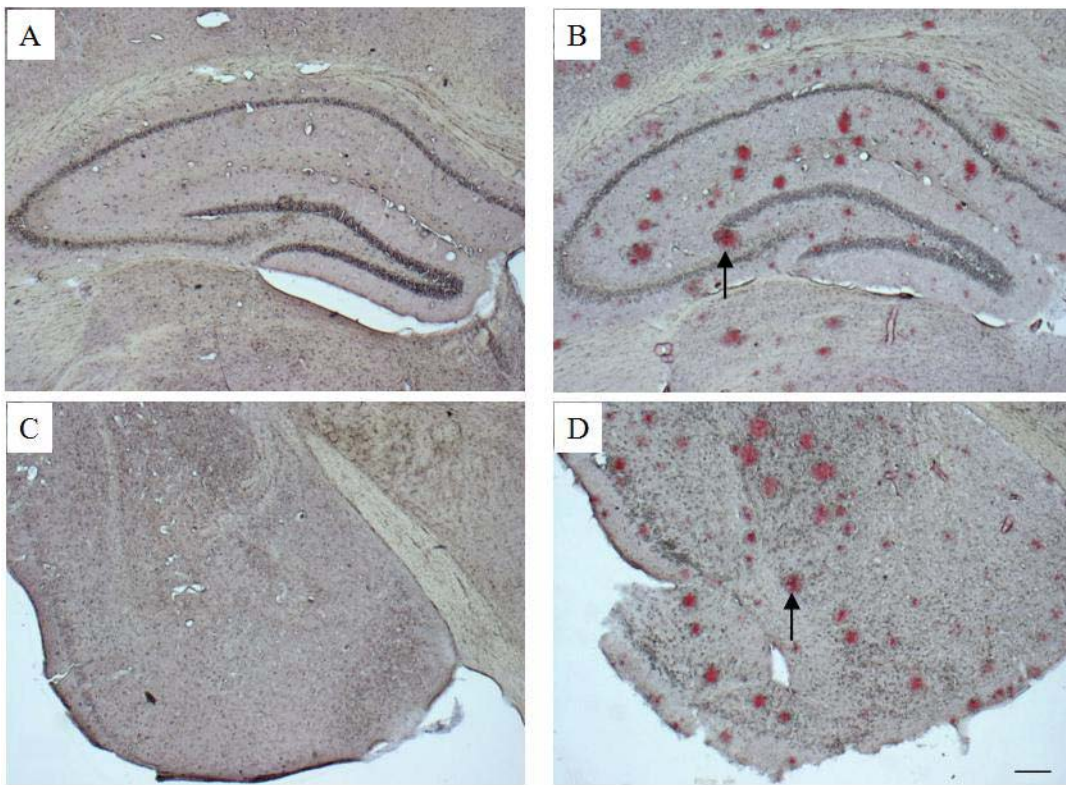

Figure 16. Representative photomicrographs of Congo Red staining showing A β plaques in the hippocampus and BLA of 12-month of age APP/PS1 mice.

A β plaques in the hippocampus of 12-month non-transgenic (A), APP/PS1 transgenic (B) mice, and in the BLA of 12-month non-transgenic (C), APP/PS1 transgenic (D) mice. The arrows indicate the positive A β plaques of Congo Red staining. Scale bar = 200 μ m.

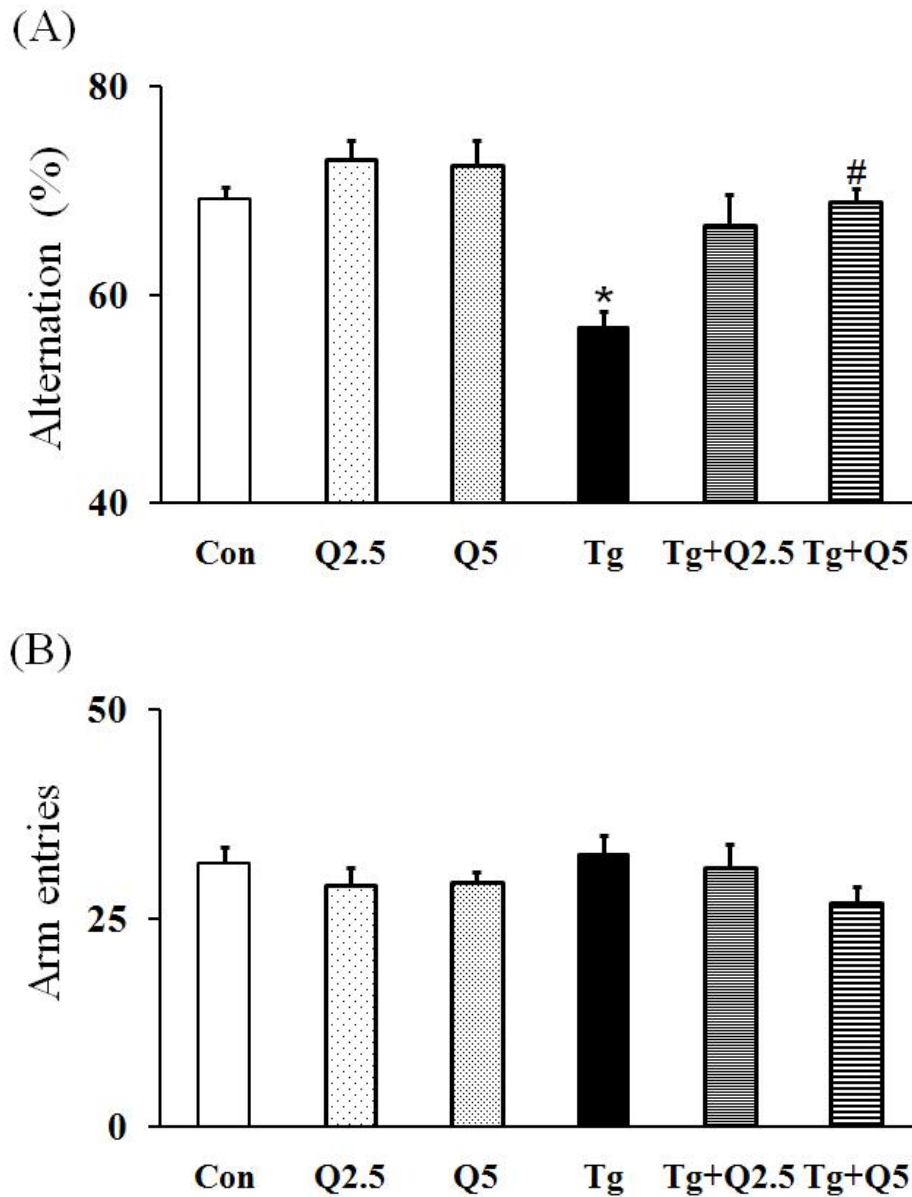

Figure 17. Y-maze test in 9-month old mice.

Effects of genotype (transgene versus control) and treatment group (quetiapine versus water) on the alternation performance (A), and on the number of total arm entries (B) in a Y-maze test in 9 month old non-transgenic and transgenic male and female mice: Con: Control (non-transgenic); Q5: quetiapine 5 mg/Kg/day in non-transgenic Q2.5: quetiapine 2.5 mg/Kg/day in non-

transgenic; Tg: APP/PS1 double transgenic in water treatment group; Tg+Q2.5: APP/PS1 double transgenic in quetiapine 2.5mg/kg/day treated group; Tg+Q5: APP/PS1 double transgenic in quetiapine 5mg/kg/day treated group. Quetiapine was administered in drinking water from the age of 2 months. Results are expressed as means±S.E.M. * $p < 0.05$ vs. Con; # $p < 0.05$ vs. Tg.

3.5. Learning and Memory in the Water Maze

There were significant 2-way interactions between genotype and treatment group in the 9-month old mice, $F(2, 112) = 3.82$, $p = 0.025$, and between genotype and training, $F(3, 336) = 3.67$, $p = 0.013$. For the 9-month-old mice, there was a 3-way interaction among genotype, treatment, and training, $F(6, 336) = 2.63$, $p = 0.017$. A Newman Keuls *post hoc* analysis indicated that the escape latency in blocks 2, 3, and 4 for the transgenic mice was higher than for the non-transgenic control mice, and that quetiapine significantly prevented the increase of escape latency in the transgenic mice (Figure 16A). In the probe test of the control mice, the mice spent more time (%) in the target quadrant than in the other quadrants, ($p < 0.05$). In the probe test of the (Figure 16B), two-way ANOVA showed that genotype, $F(1, 112) = 24.21$, $p < 0.0001$ and treatment, $F(2, 112) = 3.30$, $p = 0.040$, had effects on the time (%) spent searching for the target quadrant, and that there was interaction between genotype and treatment, $F(2, 112) = 4.45$, $p = 0.014$. A Newman Keuls *post hoc* analysis indicated that the transgenic mice spent less time (%) in the target quadrant compared to the control animals, and that quetiapine significantly prevented the decrease in time (%) in the target quadrant in the transgenic mice (Figure 16B). There was no statistical difference in the swimming speed among the groups of 9-month-old mice in the learning or the probe trials.

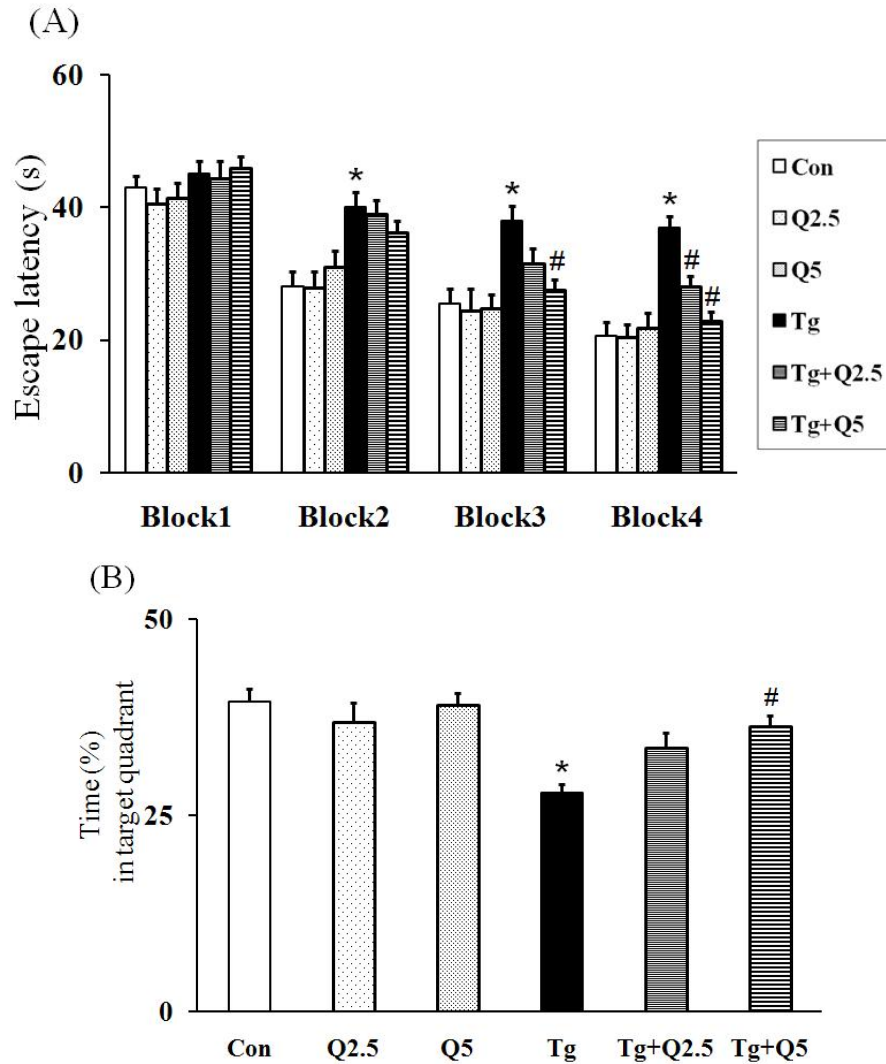

Figure 18. Escape latency of the hidden-platform test and percentage of time in the probe test.

Effects of chronic administration of quetiapine on the escape latency of the hidden-platform test (A), and on the percentage of time in the target quadrant (trained) of the probe test (B) in the water maze test in 9 month old non-transgenic and transgenic mice. Control (non-transgenic); Q5: quetiapine 5 mg/Kg/day in non-transgenic Q2.5: quetiapine 2.5 mg/Kg/day in non-transgenic; Tg: APP/PS1 double transgenic in water treatment group; Tg+Q2.5: APP/PS1 double transgenic in quetiapine 2.5mg/kg/day treated group; Tg+Q5: APP/PS1 double transgenic in quetiapine 5mg/kg/day treated group. Quetiapine was administered in drinking water from the age of 2 months. Results are expressed as means±S.E.M. * $p < 0.05$ vs. Con; # $p < 0.05$ vs. Tg.

CHAPTER 4: DISCUSSION

The purpose of this study was to examine the effects of quetiapine on anxiety-like behaviour in an APP/PS1 double transgenic mouse model of AD and to investigate the relationship between anxiety and BDNF levels in the BLA and hippocampus in these same mice. This study also helped to clarify the conflicting findings reported in recent studies that investigated anxiety in the APP/PS1 and the long-term effects of quetiapine on anxiety in AD models. This study was designed to investigate the relation of anxiety and memory impairment in a mouse model of AD, and to evaluate a potential drug treatment for anxiety in the same model. Spatial memory was examined using the Y-maze and Water maze test. Anxiety was examined using the ETM task. This study contributes to not only understanding the relationship between BPSD and memory deficits, it also has implications for early diagnoses and drug intervention in AD patients. Finally, the present study contributes to the literature pertaining to the neuroprotective effects of quetiapine on A β plaques, memory impairments, anxiety-like behaviours and BDNF levels.

This discussion is comprised of five main sections. The first section discusses that, similar to previous reports (see He et al., 2007), the present study confirms the presence of an accumulation of A β plaque load and memory impairment in the APP/PSI double transgenic mice. The second section discusses the expression of conditioned anxiety in the ETM task, and incorporates statistical analyses for the transgene and wild-type groups not receiving quetiapine treatment as a measure of reliability of the ETM in eliciting conditioned anxiety in the groups. The third section discusses the effect of chronic administration of quetiapine treatment on conditioned anxiety in the APP/PS1. In the fourth section, a discussion of the role of BDNF in the BLA and hippocampus of the transgene mice is presented, integrating statistical analyses of the groups. The fifth section presents a discussion pertaining to implications of the theoretical model in this study as well as future research.

Alzheimer's disease, a neurodegenerative disorder affecting ~2% of the population in industrialized countries (<http://www.alz.org>), is characterized by cognitive and memory deterioration, progressive impairment of activities of daily living, and a variety of neuropsychiatric symptoms. Atypical antipsychotics are widely used to treat psychotic

symptoms, aggression, and agitation associated with AD (Caballero et al., 2006; Street et al., 2000; Wolfgang, 1999). There is increasing evidence that quetiapine has neuroprotective effects in neurodegenerative diseases (Wang et al., 2005), however, it is not known if it can reverse the pathological changes that occur in AD and reduce the cognitive and behavioural phenotypes that follow. This project is important because it addresses the mechanisms underlying quetiapine's preventive and therapeutic effects in AD. It also enhances our understanding of the pathophysiology of AD and will facilitate the development of novel therapeutic strategies in the treatment of AD. Transgenic mice overexpressing genes whose mutations are associated with familial AD, such as APP (Hsiao et al., 1996), PS1 (Duff et al., 1996) or PS2 (Oyama et al., 1998), have been shown to mimic many of the distinguishing traits of AD, including memory impairment, amyloid plaques, tauopathy, neuronal loss and gliosis. APP transgenic mice show marked elevation of A β peptide level and plaques in the cerebral cortex and hippocampus from approximately 9-12 month old mice (Hsiao et al., 1996). Mutant PS1 transgenic mice do not show abnormal pathology, but do display subtly elevated levels of the A β 42/43 peptide (Duff et al., 1996). Transgenic mouse models of AD that carry APP and/or PS1 mutated genes do develop AD-like pathology and memory impairment, and are useful for testing possible drug therapeutics of AD (Holcomb et al., 1998; Hsiao et al.; Games et al., 1995; Sturchler-Pierrat et al., 1997). Double transgenic mice carrying both APP and PS1 mutations show accelerated Alzheimer phenotype compared with APP single transgenic mice (Holcomb et al.). The APP/PS1 double transgenic mice are, therefore, useful in the study of AD.

4.1 Report of A β plaque load and memory impairment

Consistent with previous reports (Arendash et al., 2001; Holcomb et al., 1998; Matsuoka et al., 2001), APP/PS1 transgenic mice in the present study demonstrated memory impairment and high levels of A β plaques. Chronic administration of quetiapine prevented the alternation behaviour impairment, acquisition and retention impairment in the transgenics, suggesting the overall improvement of spatial memory. However, one of the limitations regards the sample size of our subjects. Although there were significant differences between the groups, the number of mice used to assess memory impairment was small and a future study investigating the effects of

atypical antipsychotics including quetiapine should account for this limitation. Chronic administration of quetiapine also decreased the number A β plaques in the APP/PS1.

According to Holcomb et al. (1998), memory impairment and increased A β plaques may occur almost at the same time point or, as the present study revealed, memory impairment may occur following A β plaques (He et al., 2007). In support of the present study's findings, previous studies have concluded that memory impairment may be associated with increased brain A β plaque deposits (Arendash et al., 2001; Puoliväli et al., 2002). Furthermore, increased brain A β plaques may be the primary influence resulting in neuronal degeneration in AD (Hardy and Selkoe, 2002), impaired long term potentiation in APP/PS1 transgenic mice (Chapman et al., 1999), and the inflammatory responses demonstrated in a transgenic model of AD (Matsuoka et al., 2001). Therefore, the beneficial effects of the chronic administration of quetiapine on memory impairment in the transgenic mice may in turn be associated with decreasing the formation of brain A β plaques.

4.2. Phenotype of Conditioned Anxiety and Unconditioned Anxiety in the ETM

In parallel with other studies on anxiety-like behaviours in the APP/PS1 mouse (He et al. 2007; Jensen et al. 2005; Ognibene et al. 2005; Pugh et al. 2007), the findings in the present study confirm impaired anxiety-like behaviour. Conditioned anxiety can be related to GAD and unconditioned anxiety can be related to PD. In reference to our first hypothesis, avoidance (third trial) of the ETM revealed impaired conditioned anxiety in the female transgenic mice. However, one of the limitations is that the male mice displayed high variability within the groups and higher latencies than females (not shown), this can be considered as an indication of an overall increased level of anxiety in the male mice. One obvious explanation is that all males were individually housed –because of aggressive behaviour in the transgenic males– compared to females that were caged in groups of 4 to 5. Social isolation has already been described in the past to increase levels of anxiety (Hilakivi, Ota, & Lister, 1989). Unfortunately, there is no way to avoid this; we must maintain the safety and comfort of the animals. Also the escape (third trial) of the ETM revealed impaired unconditioned anxiety in the female transgenic mice. More specifically, the avoidance and escape latencies were decreased in transgenic female mice, at 12 months of age in comparison with the control group. Chronic administration of quetiapine

resulted in an increase of the avoidance latency in the transgenic females to control levels during the avoidance 2 phase, but did not alter the escape latency.

4.3. Chronic Administration of Quetiapine: Effect on Conditioned Anxiety

In order to test the therapeutic effects of quetiapine in treating the behaviours, the APP/PS1 transgenic mouse model of AD was used in this study. The mice were treated with quetiapine beginning at the age of 2 months. Chronic administration of quetiapine improved the impaired anxiety-like behaviour. In the present study, quetiapine seemed to *normalize* the conditioned anxiety-like behaviour in the ETM in female transgenic mice. In other words, quetiapine increased the latency of the APP/PS1 in the avoidance 2, suggesting that the mice remembered the anxiogenic environment. To date, this conclusion has not been documented elsewhere. The APP/PS1 showed panic-like symptoms in the escape 3 phase. However, no significant difference was observed with the treatment for the escape latency implying that the treatment did not have an effect on the panic-like behaviour or unconditioned anxiety. The avoidance is a reliable expression of conditioned anxiety in these transgenic mice, and the ETM is a useful tool for the study of conditioned anxiety in mice. Consistent with present findings, Carvalho-Netto and Nunes-de-Souza (2004) suggested there is no effect from any treatment on mice that exhibit unconditioned anxiety or escape behaviour. Consequently, it is challenging to use the latency to leave the open arms as a useful parameter in this model for mice.

Quetiapine maintained the BDNF levels in the transgenic females. This drug significantly increased the BDNF positive cells to normal levels in the amygdala and hippocampal area of female APP/PS1. Quetiapine may have indirectly caused the observed behaviours by its potential neuroprotective effects. Such findings highlight that the effects of quetiapine on anxiety-like changes may be affecting the progression of memory and pathological changes.

4.4. Role of BDNF in BLA and Hippocampus

Reduced expression of BDNF mRNA levels has been observed in human post-mortem AD patients' hippocampi and temporal cortices (Connor et al., 1997). The loss of BDNF may contribute to the progressive atrophy of neurons in AD. Further, the A β plaque deposition and

neurofibrillary tangles are found mainly in the brain regions involved with cognition and emotional behaviour, such as the entorhinal cortex, hippocampus, basal forebrain and amygdala (Mattson, 2004). Connor et al. and Mattson (2004) reported that other regions could contribute to the pathology associated with the behaviours found in AD; however this study focused on the amygdala and hippocampus. Ou and Gean (2007) suggested that BDNF in the amygdala is a marker for the acquisition of conditioned anxiety. Our data suggest that quetiapine is beneficial in treating anxiety by normalizing the anxiety levels related to memory impairment, and increasing neuroprotectant factors in AD patients. Prior to the present study, quetiapine's ability to *normalize* conditioned-anxiety in the mouse model of AD had not been reported. More recently, He et al. (2007) found that quetiapine was effective in treating anxiety-like behaviours and pathological changes in the APP/PS1 mouse model of AD; further supporting its neuroprotective function in treating neurodegenerative diseases. On the other hand, one reason for the uncertain effects of quetiapine on cognition may be that the neuroprotective effects might be weakened or even lost as the AD-pathology progresses.

Alzheimer's Disease is caused by a series of biological risks and stressors (Cummings & Zhong, 2006). Biological risks include genetic factors and age; stressors include environmental factors and diet. Together these factors will promote the over-expression and abnormal processing of APP, misfolding of this protein or the inability to clear the expressed A β , all of which could contribute to aggregation and amyloid plaque formation. In addition, the hyperphosphorylation of tau, a microtubule-associated protein, will result in the self-assembly of neurofibrillary tangles made up of paired helical filaments and straight filaments inside neurons. Then microtubules disintegrate, causing the neuron's transport system to collapse and result in malfunctions in biochemical communication. Together, the amyloid plaques and the tau protein abnormalities produce inflammation, oxidation, excitotoxicity, apoptosis, and receptor and neurotransmitter deficits. Pathological changes in the limbic regions induce the psychological and behavioural symptoms of dementia and changes in neocortical regions produce the cognitive impairments (Cummings & Zhong).

Currently, studies have demonstrated the effectiveness of atypical antipsychotics for treating cognitive impairment, neurodegeneration (Carson, McDonagh & Peterson, 2006), and more recently BPSD (Rocca et al., 2008). Atypical antipsychotics, including quetiapine, are used in treating patients with BPSD such as psychoses, aggression and agitation (Caballero et al.,

2006; Scharre & Chang, 2002; Street et al., 2000). It has already been suggested that quetiapine can alleviate cognitive impairment and pathological changes in the APP/PS1, and further indicate that quetiapine may be beneficial in treating AD (He et al., 2007).

In this study we demonstrated the effects of quetiapine on anxiety-like behaviour in the APP/PS1 mouse. As previously mentioned, BDNF is a neurotrophic factor involved in growth, survival and differentiation of new neurons. There is a strong relationship between BDNF levels and mood disorders (Duman 2004; Hashimoto, Shimizu, & Iyo, 2004). Evidence suggests that BDNF has trophic effects on serotonergic (Mamounas et al., 2000), noradrenergic (Fawcett et al., 1998), dopaminergic (Lara, Kusano, House, & Gainer, 2003), and cholinergic neurons (Koliatsos et al., 1994). Quetiapine's beneficial effects on anxiety-like behaviours may be associated with the blockade of BDNF decrease (Figure 11). Quetiapine may be beneficial as a neuroprotectant in treating the BPSD associated with AD. Similarly, chronic administration (21 days) of quetiapine (10 mg/kg) alleviated the BDNF mRNA decrease in the hippocampus of rats caused by immobilization stress (Xu et al., 2002). A single dose of quetiapine also increased BDNF mRNA expression in the rat hippocampus when treated with the NMDA antagonist MK-801, but not in the cortex (Fumagalli et al., 2004). More recently, Park et al. (2006) demonstrated that chronic administration of quetiapine significantly alleviated the decreased BDNF mRNA expression in the both hippocampus and cortex caused by stress-induced immobilization, and significantly increased the BDNF mRNA expression in the dentate gyrus of rats without stress-induced immobilization.

4. 5. General Discussion and Implications of Future Research

In order to advance knowledge regarding anxiety in AD, our future aim will be to examine age and sex differences in the APP/PS1. It is possible that age is a potential covariate in the expression of conditioned anxiety. For instance, in one study (Küçük, Gölgeli, Saraymen, & Koç, 2008), the avoidance latency increased with age in the ETM, which the authors suggested might be linked to memory impairment. Further studies are needed to investigate different age groups and sex to determine whether they display the conditioned anxiety that we observed in 12 month old mice.

Ou and Gean (2007) highlighted the signal cascades linking the initial physiological events by which anxiety conditioning modulates the expression of BDNF in the lateral amygdala. It is critical that future studies focus on the mechanism through which quetiapine exerts its beneficial effect on conditioned anxiety in the APP/PS1 mice. In summary, studies are necessary to elucidate the direct and/or indirect factors that may be involved in quetiapine's regulation of BDNF in these transgenic mice. Future studies should also include investigations on the precise processes involved in other atypical antipsychotics and on other neurotrophic factors.

As with the study done by He et al. (2007), the current findings suggest that quetiapine may be useful in treating the BPSD, memory impairment and pathological changes associated with AD. However, what is unique to our study is that chronic administration of quetiapine tended to normalize the ETM-induced conditioned anxiety-like behaviour and prevented the BDNF decrease in the BLA of female APP/PS1. Furthermore, consistent with the clinical study of Savaskan et al. (2006), the current study highlights the possible effects of quetiapine on specific anxiety-like (GAD) behaviours and the link with BDNF changes in the amygdala of APP/PS1 mouse model of AD. This is the first study to demonstrate this in an animal model of AD. Future studies should assess the effect of other atypical antipsychotic drugs on inhibitory avoidance in the APP/PS1.

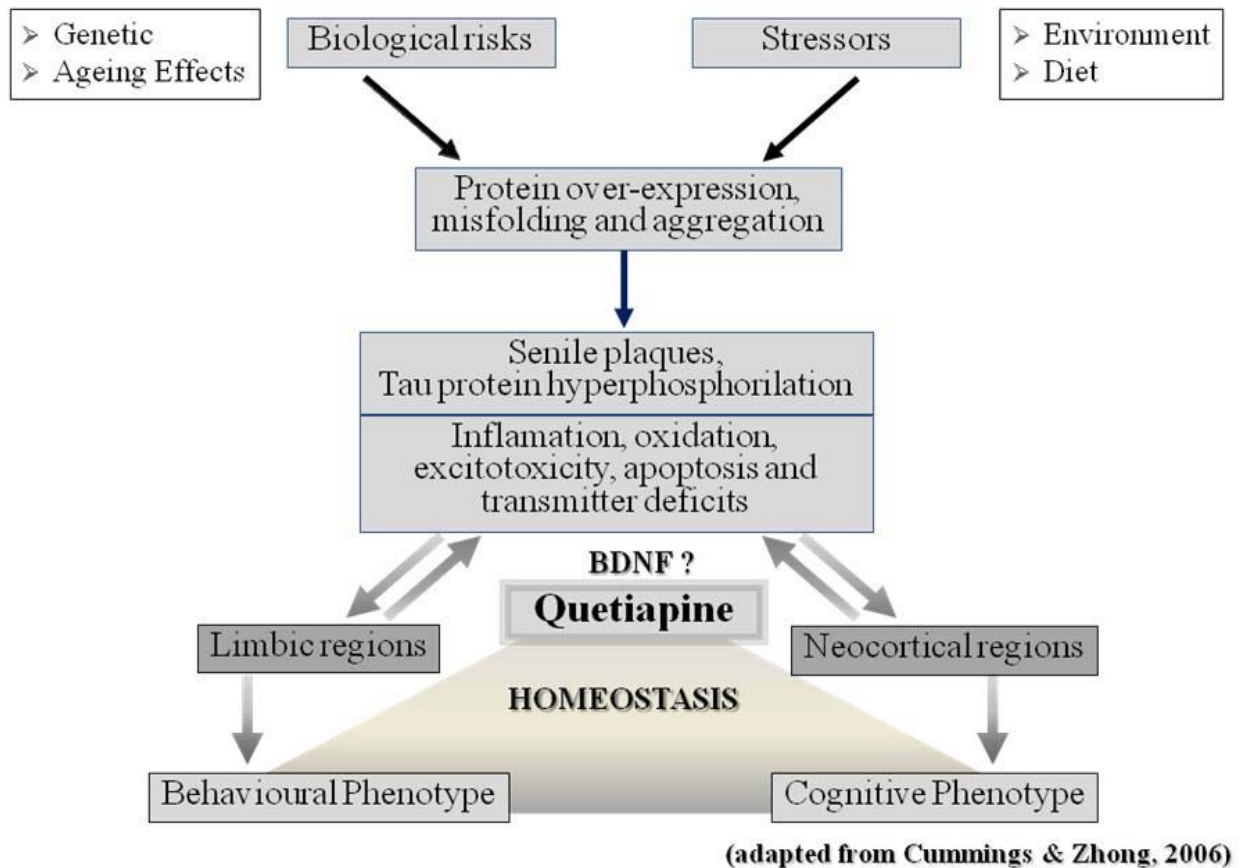

Figure 19. Conceptual model of Alzheimer's disease and quetiapine's therapeutic effects through BDNF.

The risk of developing Alzheimer's disease may be increased by biological factors such as genetic predispositions, ageing; and environmental stressors such as diet. These may induce pathological changes in overexpression, misfolding and aggregation of A β in the brain. Depending on the damaged area, it may provoke behavioural changes such as anxiety in the limbic regions or cognitive impairment such as memory loss in neocortical regions. Quetiapine may be useful in treating the behavioural and psychological symptoms of dementia (BPSD), memory impairment and pathological changes. One of quetiapine's pathways may be by increasing BDNF levels in the hippocampus and the amygdala.

References

- Aalten, P., van Valen, E., Clare, L., Kenny, G., & Verhey, F. (2005). Awareness in dementia: A review of clinical correlates. *Aging Mental Health, 9*, 414-422.
- Aggleton, J. P., & Mishkin, M. (1986). The amygdala: Sensory gateway to the emotions. In R. Plutehik & H. Kellerman (Eds.), *Emotion: Theory, research and experience* (pp. 981-999). Orlando, FL: Academic Press.
- Alheid, G. E., de Olmos, J. S., & Beltramino, C. A. (1995). Amygdala and extended amygdala. In G. Paxinos (Ed.), *The rat nervous system* (2nd ed.) (pp. 495-578). San Diego, CA: Academic Press.
- Alves, S. H., Pinheiro, G., Motta, V., Landeira-Fernandez, J., & Cruz, A. P. M. (2004). Anxiogenic effects in the rat elevated plus-maze of 5-HT(2C) agonists into ventral but not dorsal hippocampus. *Behavioural Pharmacology, 15*, 37-43.
- American Psychiatric Association. (2000). *Diagnostic and statistical manual of mental disorders* (text revision). Washington, DC: Author.
- Arendash, G. W., King, D. L., Gordon, M. N., Morgan, D., Hatcher, J. M. Hope, C. E., et al. (2001). Progressive, age-related behavioral impairments in transgenic mice carrying both mutant amyloid precursor protein and presenilin-1 transgenes. *Brain Research, 891*, 42-53.
- Arnold, S. E., & Trojanowski, J. Q. (1996). Recent advances in defining the neuropathology of schizophrenia. *Acta Neuropathologica, 92*, 217-231.
- Asai, M., Hattori, C., Iwata, N., Saido, T. C., Sasagawa, N., Szabo, B., et al. (2006). The novel beta-secretase inhibitor KMI-429 reduces amyloid beta peptide production in amyloid precursor protein transgenic and wild-type mice. *Journal of Neurochemistry, 96*, 533-540.
- Assal, F., Alarcon, M., Solomon, E. C., Masterman, D., Geschwind, D. H., & Cummings, J. L. (2004). Association of the serotonin transporter and receptor gene polymorphisms in neuropsychiatric symptoms in Alzheimer disease. *Archives of Neurology, 61*, 1249-1253.
- Baldwin, D. S., Anderson, I. M., Nutt, D. J., Bandelow, B., Bond, A., Davidson, J. R. T., et al. (2005). Evidence-based guidelines for the pharmacological treatment of anxiety disorders: Recommendations from the British Association for Psychopharmacology. *Journal of Psychopharmacology, 19*, 567-596.

- Ballard, C., Boyle, A., Bowler, C., & Lindesay, J. (1996). Anxiety disorders in dementia sufferers. *International Journal of Geriatric Psychiatry, 11*(11), 987-990.
- Ballard, C., Piggott, M., Johnson, M., Cairns, N., Perry, R., McKeith, I., et al. (2000). Delusions associated with elevated muscarinic binding in dementia with lewy bodies. *Annals of Neurology, 48*, 868-876.
- Ballard, C., Margallo-Lana, M., Juszczak, E., Douglas, S., Swann, A., Thomas, A., et al. (2005). Quetiapine and rivastigmine and cognitive decline in Alzheimer's disease: Randomised double blind placebo controlled trial. *British Medical Journal (Clinical Research Ed.), 330*, 874.
- Ballard, C., Neill, D., O'Brien, J., McKeith, I. G., Ince, P., & Perry, R. (2000). Anxiety, depression and psychosis in vascular dementia: Prevalence and associations. *Journal of Affective Disorders, 59*, 97-106.
- Ballenger, J. C. (1993). Panic disorder: Efficacy of current treatments. *Psychopharmacology Bulletin, 29*, 477-486.
- Bandler, R., & Shipley, M. T. (1994). Columnar organization in the midbrain periaqueductal gray: Modules for emotional expression? *Trends in Neurosciences, 17*, 379-389.
- Bannerman, D. D., Paape, M. J., Hare, W. R., & Sohn, E. J. (2003). Increased levels of LPS-binding protein in bovine blood and milk following bacterial lipopolysaccharide challenge. *Journal of Dairy Science, 86*, 3128-3137.
- Bannerman, D. M., Matthews, P., Deacon, R. M. J., & Rawlins, J. N. P. (2004). Medial septal lesions mimic effects of both selective dorsal and ventral hippocampal lesions. *Behavioral Neuroscience, 118*, 1033-1041.
- Battaglia, M., & Ogliari, A. (2005). Anxiety and panic: From human studies to animal research and back. *Neuroscience and Biobehavioral Reviews, 29*, 169-179.
- Beaulieu, S., DiPaolo, X., Cote, J., & Harden, N. (1987). Participation of the central amygdaloid nucleus in the response of adrenocorticotropin secretion to immobilization stress: Opposing roles of the noradrenergic and dopaminergic systems. *Journal of Synchrontron Radiation, 45*, 37-46.
- Bai, O., Wei, Z., Lu, W., Bowen, R., Keegan, D., & Li, X. M. (2002) Protective effects of atypical antipsychotic drugs on PC12 cells after serum withdrawal. *Journal of Neuroscience Research 69*, 278-283.

- Bai, O., Zhang, H., & Li, X. M. (2004) Antipsychotic drugs clozapine and olanzapine upregulate bcl-2 mRNA and protein in rat frontal cortex and hippocampus. *Brain Research*, 1010, 81-86.
- Beasley, C. M., Jr, Tollefson, G. D., & Tran, P. V. (1997) Efficacy of olanzapine: an overview of pivotal clinical trials. *Journal of Clinical Psychiatry*, 58(10), 7-12.
- Bernard, J. F., Alden, M., & Besson, J. M. (1993). The organization of the efferent projections from the pontine parabrachial area to the amygdaloid complex: A phaseolus vulgaris leucoagglutinin (PHA-L) study in the rat. *Journal of Comparative Neurology*, 329, 201.
- Beuzen, A., & Belzung, C. (1995). Link between emotional memory and anxiety states: A study by principal component analysis. *Physiology Behavior*, 58, 111-118.
- Bird, T. D. (2008). Genetic aspects of Alzheimer disease. *Genetics in Medicine*, 10, 231-239.
- Blier, P., de Montigny, C., & Chaput, Y. (1987). Modifications of the serotonin system by antidepressant treatments: Implications for the therapeutic response in major depression. *Journal of Clinical Psychopharmacology*, 7, 245-355.
- Bondareff, W. (1996). Neuropathology of psychotic symptoms in alzheimer's disease. *International Psychogeriatrics*, 8, 233-254.
- Bruckheimer, E. M., Cho, S. H., Sarkiss, M., Herrmann, J., & McDonnell, T. J. (1998). The Bcl-2 gene family and apoptosis. *Advances in Biochemical Engineering/Biotechnology*, 62, 75-105.
- Bruel-Jungerman, E., Rampon, C., & Laroche, S. (2007). Adult hippocampal neurogenesis, synaptic plasticity and memory: facts and hypotheses. *Nature Reviews Neuroscience* 18, 93-114.
- Brugue, E., & Vieta, E. (2007). Atypical antipsychotics in bipolar depression: neurobiological basis and clinical implications. *Progress in Neuro-psychopharmacol and Biological Psychiatry*, 31, 275-282.
- Burbach, G.J., Hellweg, R., Haas, C.A., Del Turco, D., Deicke, U., Abramowski, D., et al. (2004). Induction of brain-derived neurotrophic factor in plaque-associated glial cells of aged APP23 transgenic mice. *Journal of Neuroscience*, 24, 2421 – 2430.
- Burwell, R. D., Witter, M. P., & Amaral, D. G. (1995). Perirhinal and postrhinal cortices of the rat: A review of the neuroanatomical literature and comparison with findings from the monkey brain. *Hippocampus*, 5(5), 390.

- Caballero, J., Hitchcock, M., Scharre, D., Beversdorf, D., & Nahata, M. C. (2006). Cognitive effects of atypical antipsychotics in patients with Alzheimer's disease and comorbid psychiatric or behavioral problems. *Clinical Therapy*, 28, 1695-1700.
- Cahill, L., & McGaugh, J. L. (1998). Mechanisms of emotional arousal and lasting declarative memory. *Trends in Neurosciences*, 21, 294-299.
- Calhoun, M. E., Wiederhold, K. H., Abramowski, D., Phinney, A. L., Probst, A., Sturchler-Pierrat, C., et al. (1998). Neuron loss in APP transgenic mice. *Nature*, 395, 755-756.
- Campeau, S., & Davis, M. (1995a). Involvement of subcortical and cortical afferents to the lateral nucleus of the amygdala in fear conditioning measured with fear-potentiated startle in rats trained concurrently with auditory and visual conditioned stimuli. *The Journal of Neuroscience*, 15, 2312-2317.
- Campeau, S., & Davis, M. (1995b). Involvement of the central nucleus and basolateral complex of the amygdala in fear conditioning measured with fear-potentiated startle in rats trained concurrently with auditory and visual conditioned stimuli. *The Journal of Neuroscience*, 15, 2301-2311.
- Canadian Study of Health and Aging Work Group. (1994) Canadian Study of Health and Aging: study methods and prevalence of dementia. *Canadian Medical Association Journal*, 150, 899-913.
- Canteras, N. S., & Swanson, L. W. (1992). Projections of the ventral subiculum to the amygdala, septum, and hypothalamus: A PHAL anterograde tract-tracing study in the rat. *Journal of Comparative Neurology*, 324, 180-194.
- Cantillon, M., Harwood, D., Barker, W., St George-Hyslop, P., Tsuda, T., Ekatarina, R., et al. (1997). No association between apolipoprotein E genotype and late-onset depression in Alzheimer's disease. *Biological Psychiatry*, 41, 246-248.
- Capsoni, S., Ugolini, G., Comparini, A., Ruberti, F., Berardi, N., & Cattaneo, A. (2000). Alzheimer-like neurodegeneration in aged antinerve growth factor transgenic mice. *Proceedings of the National Academy of Sciences, USA*, 97, 6826-6831.
- Carlezon, J., William, A., Duman, R. S., & Nestler, E. J. (2005). The many faces of CREB. *Trends in Neurosciences*, 28, 436-445.
- Carrive, P. (1993). The periaqueductal gray and defensive behavior: Functional representation and neuronal organization. *Behavioural Brain Research*, 58, 27-47.

- Carson, S., McDonough, M. S., & Peterson, K. A. (2006). A systematic review of the efficacy and safety of atypical antipsychotics in patients with psychological and behavioral symptoms of dementia. *Journal of the American Geriatrics Society*, *54*, 354-361.
- Carvalho-Netto, E. F., & Nunes-de-Souza, R. L. (2004). Use of the elevated T-maze to study anxiety in mice. *Behavioural Brain Research*, *148*, 119-132.
- Cases, O., Vitalis, T., Seif, I., De Maeyer, E., Sotelo, C., & Gaspar, P. (1996). Lack of barrels in the somatosensory cortex of monoamine oxidase A-deficient mice: Role of a serotonin excess during the critical period. *Neuron*, *16*, 297-307.
- Catherall, D. R. (2003). How fear differs from anxiety. *Traumatology*, *9*(2), 76-92.
- Chapman, P. F., White, G. L., Jones, M. W., Cooper-Blacketer, D., Marshall, V. J., Irizarry, M., et al. (1999). Impaired synaptic plasticity and learning in aged amyloid precursor protein transgenic mice. *Nature Neuroscience*, *2*, 271-276.
- Chemerinski, E., Petracca, G., Manes, F., Leiguarda, R., & Starkstein, S. E. (1998). Prevalence and correlates of anxiety in Alzheimer's disease. *Depression and Anxiety*, *7*(4), 166.
- Chen, J. C., Borson, S., & Scanlan, J. M. (2000). Stage-specific prevalence of behavioral symptoms in Alzheimer's disease in a multi-ethnic community sample. *The American Journal of Geriatric Psychiatry*, *8*, 123-133.
- Chen, Z., Xu, H., Haimano, S., Li, X., & Li, X. M. (2005). Quetiapine and venlafaxine synergistically regulate heme oxygenase-2 protein expression in the hippocampus of stressed rats. *Neuroscience Letters*, *389*, 173-177.
- Chen, Z. Y., Jing, D., Bath, K. G., Ieraci, A., Khan, T., Siao, C. J., et al. (2006). Genetic variant BDNF(Val66Met) polymorphism alters anxiety-related behavior. *Science*, *314*, 140-143.
- Chhatwal, P. C., Stanek-Rattiner, L., Davis, M., & Ressler, K. J. (2006). Amygdala BDNF signaling is required for consolidation but not encoding of extinction. *Nature Neuroscience*, *9*, 870-872.
- Chishti, M. A., Yang, D. S., Janus, C., Phinney, A. L., Horne, P., Pearson, J., et al. (2001). Early-onset amyloid deposition and cognitive deficits in transgenic mice expressing a double mutant form of amyloid precursor protein 695. *Journal of Biological Chemistry*, *276*, 21562-21570.
- Clement, Y., & Chapouthier, G. (1998). Biological bases of anxiety. *Neuroscience and Biobehavioral Reviews*, *22*, 623-633.

- Cloninger, C. R. (1987). A systematic method for clinical description and classification of personality variants. A proposal. *Archives of General Psychiatry*, *44*, 573-588.
- Colton, C. A., Vitek, M.P., Wink, D.A., Xu, Q., Cantillana, V., Previti, M.L., et al. (2006). NO synthase 2 (NOS2) deletion promotes multiple pathologies in a mouse model of Alzheimer's disease. *Proceedings of the National Academy of Sciences, USA*, *103*, 12867-12872. Erratum in: *Proceedings of the National Academy of Sciences, USA*, *103*,15273.
- Connor, B., Young, D., Yan, Q., Faull, R.L., Synek, B., & Dragunow, M. (1997). Brain-derived neurotrophic factor is reduced in Alzheimer's disease. *Molecular Brain Research*, *49*, 71-81.
- Coplan, J., Wolk, S. & Klein, D. (1995) in *Anxiety and the Serotonin1A Receptor*, eds. Bloom, F. & Kupfer, D. (Raven, New York), pp. 1301–1310.
- Corodimas, K. P., & LeDoux, J. E. (1995). Disruptive effects of posttraining perirhinal cortex lesions on conditioned fear: Contributions of contextual cues. *Behavioral Neuroscience*, *109*, 613-619.
- Coover, G. D., Trivedi, M. A., & Heldt, S.A. (2002). Hippocampal aspiration decreases open arm avoidance in two rat strains and both plus- and T-maze tests of anxiety. *Abstracts of the International Behavioral Neuroscience Society 11*, 69.
- Crawley, J., & Goodwin, F. K. (1980). Preliminary report of a simple animal behavior model for the anxiolytic effects of benzodiazepines. *Pharmacology, Biochemistry and Behavior*, *13*, 167-170.
- Cronbach, L.J., & Meehl, P.E. (1955). Construct validity in psychological tests. *Psychological Bulletin*, *52*, 281-302.
- Cuesta, M. J., Peralta, V., & Zarzuela, A. (2001) Effects of olanzapine and other antipsychotics on cognitive function in chronic schizophrenia: a longitudinal study. *Schizophrenia Research*, *48*, 17-28.
- Cummings, J. L., & Back, C. (1998). The cholinergic hypothesis of neuropsychiatric symptoms in Alzheimer's disease. *The American Journal of Geriatric Psychiatry*, *6*, 64-78.
- Cummings, J. L., Schneider, L., Tariot, P. N., Kershaw, P. R. & Yuan, W. (2004). Reduction of behavioral disturbances and caregiver distress by galantamine in patients with Alzheimer's disease. *The American Journal of Psychiatry*, *161*, 532-538.

- Cummings, J. L., Vinters, H. V., Cole, G. M., & Khachaturian, Z. S. (1998). Alzheimer's disease: Etiologies, pathophysiology, cognitive reserve, and treatment opportunities. *Neurology*, *51*(1), S2-S17.
- Cummings J. L., & Zhong, K. (2006). Treatments for behavioural disorders in neurodegenerative diseases: drug development strategies. *Nature Reviews Drug Discovery*, *5*(1), 64-74.
- Davidson, T. L. (2004). The hippocampus and inhibitory learning: A 'gray' area? *Neuroscience and Biobehavioral Reviews*, *28*, 261-271.
- Davis, M. (1998). Are different parts of the extended amygdala involved in fear versus anxiety? *Biological Psychiatry*, *44*(12), 1239.
- Davis, M., Gendelman, D. S., Tischler, M. D., & Gendelman, P. M. (1982). A primary acoustic startle circuit: Lesion and stimulation studies. *The Journal of Neuroscience*, *2*, 791-805.
- Davis, M., Walker, D. L., & Lee, Y. (1997). Amygdala and bed nucleus of the stria terminalis: Differential roles in fear and anxiety measured with the acoustic startle reflex. *Annals of the New York Academy of Sciences*, *821*, 305-331.
- Davis, J., Xu, F., Deane, R., Romanov, G., Previti, M. L., Zeigler, K., et al. (2004). Early-onset and robust cerebral microvascular accumulation of amyloid beta-protein in transgenic mice expressing low levels of a vasculotropic Dutch/Iowa mutant form of amyloid beta-protein precursor. *Biological Chemistry*, *279*, 20296-20306.
- Davis, J., Xu, F., Miao, J., Previti, M. L., Romanov, G., Ziegler, K., et al. (2006). Deficient cerebral clearance of vasculotropic mutant Dutch/Iowa double A beta in human A betaPP transgenic mice. *Neurobiology of Aging*, *27*, 946-954.
- Deasy, R., Shi, C.-J., & Davis, M. (1997). Double labeling, retrograde tracing studies of the basolateral amygdaloid nucleus projections to the lateral bed nucleus of the stria terminalis and central amygdaloid nucleus. *Neuroscience Abstracts*, *23*, 1613.
- Degroot, A., Kashluba, S., & Treit, D. (2001). Septal GABAergic and hippocampal cholinergic systems modulate anxiety in the plus-maze and shock-probe tests. *Pharmacology, Biochemistry and Behavior*, *69*, 391-399.
- Degroot, A., & Treit, D. (2002). Dorsal and ventral hippocampal cholinergic systems modulate anxiety in the plus-maze and shock-probe tests. *Brain Research*, *949*, 60-70.

- DeLisi, L. E., Sakuma, M., Tew, W., Kushner, M., Hoff, A.L., & Grimson, R. (1997). Schizophrenia as a chronic active brain process: a study of progressive brain structural change subsequent to the onset of schizophrenia. *Psychiatry Research*, *74*, 129-140.
- De-Mello, N., & Carobrez, A. P. (2002). Elevated T-maze as an animal model of memory: Effects of scopolamine. *Behavioural Pharmacology*, *13*, 139-148.
- den Boer, J. A., Westenberg, H. G., De Leeuw, A. S., & van Vliet, I. M. (1995). Biological dissection of anxiety disorders: The clinical role of selective serotonin reuptake inhibitors with particular reference to fluvoxamine. *International Clinical Psychopharmacology*, *9*, 47-52.
- De Vry, J. (1995). 5-HT_{1A} receptor agonists: Recent developments and controversial issues. *Psychopharmacology*, *121*, 1-26.
- Díaz-Mataix, L., Scorza, M. C., Bortolozzi, A., Toth, M., Celada, P., & Artigas, F., (2005). Involvement of 5-HT_{1A} Receptors in Prefrontal Cortex in the Modulation of Dopaminergic Activity: Role in Atypical Antipsychotic Action. *The Journal of Neuroscience*, *25*(47), 10831-10843.
- Duff, K., Eckman, C., Zehr, C., Yu, X., Prada, C. M., Perez-tur, J., et al. (1996). Increased amyloid-beta₄₂(43) in brains of mice expressing mutant presenilin 1. *Nature*, *383*, 710-713.
- Duman, R. S. (2004). Role of neurotrophic factors in the etiology and treatment of mood disorders. *Neuromolecular Medicine*, *5*, 11-25.
- Duman, R., Heninger, G.R., & Nestler, E.J.(1997). A molecular and cellular theory of depression. *Archives of General Psychiatry*, *54*, 597-606.
- Dunlop, B. W., & Nemeroff, C. B. (2007). The role of dopamine in the pathophysiology of depression. *Archives of General Psychiatry*, *64*, 327-337.
- Duzzioni, M., Calixto, A. V., Duarte, F. S., & De Lima, T. C. M. (2008). Modulation of anxiety in rats evaluated in the elevated T-maze: Evidence of the relationship between substance P and diazepam. *Behavioural Brain Research*, *187*, 140-145.
- Engin, E., & Treit, D. (2007). The role of hippocampus in anxiety: Intracerebral infusion studies. *Behavioural Pharmacology*, *18*, 365-374.

- Everitt, B. J., & Robbins, T. W. (1992). Amygdala-ventral striatal interactions and reward-related processes. In J. P. Aggleton (Ed.), *The amygdala: Neurobiological aspects of emotion, memory, and mental dysfunction* (pp. 401-430). New York: Wiley.
- Eysenck, M. W. (1992). *Anxiety: The cognitive perspective*. Hillsdale, NJ: Lawrence Erlbaum.
- Fahnestock, M., Garzon, D., Holsinger, R.M., Michalski, B. (2002). Neurotrophic factors and Alzheimer's disease: are we focusing on the wrong molecule? *Journal of Neural Transmission, Supplement*, 62, 241 – 252.
- Fahnestock, M., Garzon, D., Peng, D., Flood, D., Salehi, A., & Mount, H.T.J. (2006). Decreased BDNF mRNA levels in mouse models of alzheimer's disease [Abstract]. *Proceedings of the Alzheimer's and Dementia*, 2(3), S103 – S104.
- Fanselow, M. S. (1994). Neural organization of the defensive behavior system responsible for fear. *Psychonomic Bulletin Review*, 1, 429-438.
- Fawcett, J. P., Bamji, S. X., Causing, C. G., Aloyz, R., Ase, A. R., Reader, T. A., et al. (1998). Functional evidence that BDNF is an anterograde neuronal trophic factor in the CNS. *Journal of Neuroscience*, 18, 2808-2821.
- Ferrer, I., Marin, C., Rey, M.J., Ribalta, T., Goutan, E., Blanco, R., et al. (1999). BDNF and full-length and truncated TrkB expression in Alzheimer disease: Implications in therapeutic strategies. *Journal of Neuropathology and Experimental Neurology*, 58, 729 –739.
- Ferretti, L., McCurry, S. M., Logsdon, R., Gibbons, L., & Teri, L. (2001). Anxiety and Alzheimer's disease. *Journal of Geriatric Psychiatry and Neurology*, 14, 52-58.
- Forsell, Y., & Winblad, B. (1998). Feelings of anxiety and associated variables in a very elderly population. *International Journal of Geriatric Psychiatry*, 13, 454-458.
- Fukumoto, H., Rosene, D. L., Moss, M. B., Raju, S., Hyman, B. T., & Irizarry, M. C. (2004) Beta-secretase activity increases with aging in human, monkey, and mouse brain. *American Journal of Pathology*, 164, 719-725.
- Fumagalli, F., Molteni, R., Bedogni, F., Gennarelli, M., Perez, J., & Racagni, G., et al. (2004). Quetiapine regulates FGF-2 and BDNF expression in the hippocampus of animals treated with MK-801. *Neuroreport*, 15, 2109-2112.
- Gallagher, M., & Holland, P .C. (1994). The amygdala complex: Multiple roles in associative learning and attention. *Proceedings of the National Academy of Sciences of the United States of America*, 91, 11771-11776.

- Games D., Adams D., Alessandrini R., Barbour R., Berthelette P., Blackwell C., et al. (1995). Alzheimer-type neuropathology in transgenic mice overexpressing V717F β -amyloid precursor protein. *Nature*, 373(6514), 523-527.
- Garzon, D., Yu, G., & Fahnstock, M. (2002). A new brain-derived neurotrophic factor transcript and decrease in brain-derived neurotrophic factor transcripts 1, 2 and 3 in Alzheimer's disease parietal cortex. *Journal of Neurochemistry*, 82, 1058 – 1064.
- Gassen, G. V., & Annaert, W. (2003). Amyloid, presenilins, and Alzheimer's disease. *Neuroscientist*, 9(2), 117-126.
- Genazzani, A. D., Lanzoni, C., Ricchieri, F., Campedelli, A., Rattighieri, E., Santagni, S., et al. (2008). Effect of short term sibutramine on gonadotropin spontaneous pulsatile release in normogonadotropinemic amenorrheic subjects. 3(7), 361-369.
- Gomes, K. S., de Carvalho-Netto, E. F., Monte, Kátia Cristina Da Silva, Acco, B., Nogueira, Paulo José de Campos, & Nunes-de-Souza, R. L. (2009). Contrasting effects of acute and chronic treatment with imipramine and fluoxetine on inhibitory avoidance and escape responses in mice exposed to the elevated T-maze. *Brain Research Bulletin*, 78, 323-327.
- Gonzalez, L. E., Ouagazzal, A. M., & File, S. E. (1998). Stimulation of benzodiazepine receptors in the dorsal hippocampus and median raphe reveals differential GABAergic control in two animal tests of anxiety. *The European Journal of Neuroscience*, 10, 3673-3680.
- Graeff, F. G., Netto, C.F., Zangrossi, H. Jr. (1998). The elevated T-maze as an experimental model of anxiety. *Neuroscience and Biobehavioral Reviews*, 23(2), 237-246.
- Graeff, F. G., Viana, M. B., & Mora, P. O. (1996). Opposed regulation by dorsal raphe nucleus 5-HT pathways of two types of fear in the elevated T-maze. *Pharmacology, Biochemistry and Behavior*, 53, 171-177.
- Graeff, F. G., Viana, M. B., & Tomaz, C. (1993). The elevated T maze, a new experimental model of anxiety and memory: Effect of diazepam. *Brazilian Journal of Medical and Biological Research*, 26, 67-70.
- Graeff, F. G., & Zangossi, H. (2002). Animal models of anxiety. In: H, D'haenen, J.A. Den Boer, & P. Willner (Eds.), *Biological Psychiatry* (pp.1-15). New York: John Wiley, Sons Ltd.
- Gray, J. A. (1982). *The neuropsychology of anxiety: an enquiry into the functions of the septo-hippocampal system*. 1st ed. Oxford: Oxford University Press.

- Gray, J. A. (1993). Amygdaloid CRF pathways: Role in autonomic, neuroendocrine, and behavioral responses to stress. *Annals of the New York Academy of Sciences*, 697, 53-60.
- Gray, J. A., & McNaughton, N. (1996). The neuropsychology of anxiety: Reprise. In D. A. Hope (Ed.), *Nebraska Symposium of Motivation. Vol. 43. Perspectives on anxiety, panic and fear* (pp. 61-134). Lincoln: University of Nebraska Press.
- Green, M. F. (1996) What are the functional consequences of neurocognitive deficits in schizophrenia? *American Journal of Psychiatry*, 153, 321-330.
- Griebel, G. (1995). 5-Hydroxytryptamine-interacting drugs in animal models of anxiety disorders: More than 30 years of research. *Pharmacology & Therapeutics*. 65,319-395.
- Gross, C., Zhuang, X., Stark, K., Ramboz, S., Oosting, R., Kirby, L., et al. (2002). Serotonin1A receptor acts during development to establish normal anxiety-like behaviour in the adult. *Nature*, 416, 396-400.
- Gross, J. J. (1999). Emotion regulation: Past, present, future. *Cognition Emotion*, 13, 551-573.
- Hackl, L. P. N., & Carobrez, A.P. (2006). Anxiolytic-like effects of NMDA-receptor antagonist injected into the ventral but not dorsal hippocampus in rats submitted to the elevated plus-maze. *European Journal of Neuropsychopharmacology* 16, S255–S256.
- Hall, C. S. (1936). Emotional behavior in the rat. III. The relationship between emotionality and ambulatory activity. *Journal of Comparative and Physiological Psychology*, 22, 345–352
- Handley, S. L. (1995). 5-hydroxytryptamine pathways in anxiety and its treatment. *Pharmacology Therapeutics*, 66(1), 103-148.
- Hannesson, D. K., Howland, J., Pollock, M., Mohapel, P., Wallace, A. E., & Corcoran, M. E. (2001). Dorsal hippocampal kindling produces a selective and enduring disruption of hippocampally mediated behavior. *The Journal of Neuroscience*, 21, 4443-4450.
- Hardy, J., & Selkoe, D. J. (2002). The amyloid hypothesis of alzheimer's disease: Progress and problems on the road to therapeutics. *Science*, 297, 353-356.
- Haring, J. H., & Yan, W. (1999). Dentate granule cell function after neonatal treatment with parachloroamphetamine or 5,7-dihydroxytryptamine. *Developmental Brain Research*, 114, 269-272.
- Harwood, D. G., Barker, W. W., Ownby, R. L., Bravo, M., Aguero, H., & Duara, R. (2000). Depressive symptoms in Alzheimer's disease: An examination among community-dwelling cuban american patients. *The American Journal of Geriatric Psychiatry*, 8, 84-91.

- Harvey, P. D. (1998) Comprehensive clinical psychology. In: Schizophrenia and related disorders in late life, (Bellack A.S., Hersen M. eds), pp 74-86. Amsterdam: Elsevier.
- Hashimoto, K., Shimizu, E., & Iyo, M. (2004). Critical role of brain-derived neurotrophic factor in mood disorders. *Brain Research. Brain Research Reviews*, *45*, 104-114.
- He, J., Luo, H., Yan, B., Yu, Y., Wang, H., Wei, Z., et al. (2007). Beneficial effects of quetiapine in a transgenic mouse model of Alzheimer's disease. *Neurobiology of Aging*. doi:10.1016/j.neurobiolaging.2007.11.001
- He, J., Xu, H., Yang, Y., Rajakumar, D., Li, X., & Li, X. M. (2006). The effects of chronic administration of quetiapine on the phencyclidine-induced reference memory impairment and decrease of Bcl-XL/Bax ratio in the posterior cingulate cortex in rats. *Behavioral Brain Research*, *168*, 236-242.
- He, J., Xu, H., Yang, Y., Zhang, X., & Li, X. M. (2004). Neuroprotective effects of olanzapine on methamphetamine-induced neurotoxicity are associated with an inhibition of hyperthermia and prevention of Bcl-2 decrease in rats. *Brain Research*, *1018*, 186-192.
- He, J., Xu, H., Yang, Y., Zhang, X., & Li, X. M. (2005). Chronic administration of quetiapine alleviates the anxiety-like behavioural changes induced by a neurotoxic regimen of dl-amphetamine in rats. *Behavioural Brain Research*, *160*, 178-187.
- He, J., Yang, Y., Xu, H., Zhang, X., & Li, X. M. (2005). Olanzapine attenuates the okadaic acid-induced spatial memory impairment and hippocampal cell death in rats. *Neuropsychopharmacology*, *30*, 1511-1520.
- He, J., Yang, Y., Yu, Y., Li, X., & Li, X. M. (2006). The effects of chronic administration of quetiapine on the methamphetamine-induced recognition memory impairment and dopaminergic terminal deficit in rats. *Behavioral Brain Research*, *172*, 39-45.
- Hilakivi, L.A., Ota, M., Lister, R.G. (1989). Effect of isolation on brain monoamines and the behavior of mice in tests of exploration, locomotion, anxiety and behavioral "despair". *Pharmacology Biochemistry Behavior*, *33*, 371-374.
- Hindmarch, I. (1998). Cognition and anxiety: The cognitive effects of anti-anxiety medication. *Acta Psychiatrica Scandinavica*, *98*, 89-94.
- Hoe, J., Hancock, G., Livingston, G., & Orrell, M. (2006). Quality of life of people with dementia in residential care homes. *The British Journal of Psychiatry*, *188*, 460-464.

- Holcomb, L., Gordon, M.N., McGowan, E., Yu, X., Benkovic, S., Jantzen, P., et al. (1998). Accelerated alzheimer-type phenotype in transgenic mice carrying both mutant amyloid precursor protein and presenilin 1 transgenes. *Nature Medicine*, 4, 97–100.
- Holmes, C.J., Arranz, M. J., Powell, J. F., Collier, D. A., & Lovestone, S. (1998). 5-HT_{2A} and 5-HT_{2C} receptor polymorphisms and psychopathology in late onset alzheimer's disease. *Human Molecular Genetics*, 7, 1507-1509.
- Holsinger, R.M., Schnarr, J., Henry, P., Castelo, V.T. & Fahnstock, M. (2000). Quantitation of BDNF mRNA in human parietal cortex by competitive reverse transcription-polymerase chain reaction: decreased levels in Alzheimer's disease. *Brain Research. Molecular Brain Research*, 76, 347–354.
- Hostege, G. (1995). The basic, somatic, and emotional components of the motor system in mammals. In G. Paxinos (Ed.), *The rat nervous system* (2nd ed., pp. 137-154). San Diego, CA: Academic Press.
- Hoyer, D., & Schoeffter, P. (1991). 5-HT receptors: Subtypes and second messengers. *Journal of Receptor Research*, 11, 197-214.
- Hsiao, K., Chapman, P., Nilsen, S., Eckman, C., Harigaya, Y., Younkin, S., et al. (1996). Correlative memory deficits, abeta elevation, and amyloid plaques in transgenic mice. *Science*, 274, 99-102.
- Hwang, T. J., Masterman, D. L., Ortiz, F., Fairbanks, L. A., & Cummings, J. L. (2004). Mild cognitive impairment is associated with characteristic neuropsychiatric symptoms. *Alzheimer Disease and Associated Disorders*, 18, 17-21.
- Iwata, J., Chida, K., & LeDoux, J. E. (1987). Cardiovascular responses elicited by stimulation of neurons in the central amygdaloid nucleus in awake but not anesthetized rats resemble conditioned emotional responses. *Brain Research*, 418, 183-188.
- Jann, M. W. (2004) Implications for atypical antipsychotics in the treatment of schizophrenia: neurocognition effects and a neuroprotective hypothesis. *Pharmacotherapy*, 24, 1759-1783.
- Jardim, M. C., Nogueira, R. L., Graeff, F. G., & Nunes-de-Souza, R. L. (1999). Evaluation of the elevated T-maze as an animal model of anxiety in the mouse. *Brain Research Bulletin*, 48, 407-411.

- Jensen, M., Mottin, M. D., Cracchiolo, J. R., Leighty, R. E., & Arendash, G. W. (2005). Lifelong immunization with human β -amyloid (1–42) protects Alzheimer's transgenic mice against cognitive impairment throughout aging. *Neuroscience*, *130*, 667-684.
- Jin, K., Peel, A. L., Mao, X. O., Xie, L., Cottrell, B. A., Henshall, D. C., & Greenberg, D. A. (2004) Increased hippocampal neurogenesis in Alzheimer's disease. *Proceedings of the National Academy of Sciences USA*, *101*, 343-347.
- Jolas, T., Haj-Dahmane, S., Lanfumey, L., Fattaccini, C. M., Kidd, E. J., Adrien, J., et al. (1993). (-)Tertatolol is a potent antagonist at pre- and postsynaptic serotonin 5-HT_{1A} receptors in the rat brain. *Naunyn-Schmiedeberg's Archives of Pharmacology*, *347*, 453-463.
- Jorge, S. D., Pobbe, R. L., de Paula Soares, V., Oliveira, A. M., & Zangrossi, H. (2004) Effects of sibutramine on anxiety-related behaviours in rats. *Pharmacology Research*, *50*, 517-522.
- Josselyn, S. A., Shi, C., Carlezon, W. A., Neve, R. L., Nestler, E. J., & Davis, M., (2001). Long-term memory is facilitated by cAMP response element-binding protein overexpression in the amygdala. *The Journal of Neuroscience*, *21*, 2404-2412.
- Julius, D. (1991). Molecular biology of serotonin receptors. *Annual Review of Neuroscience*, *14*, 335-360.
- Juncos, J. L., Roberts, V. J., Evatt, M. L., Jewart, R. D., Wood, C. D., Potter, L. S., Jou, H. C. & Yeung, P. P. (2004). Quetiapine improves psychotic symptoms and cognition in Parkinson's disease. *Movement Disorders*, *19*, 29-35.
- Kapp, B. S. (1979). Amygdala central nucleus lesions: Effect on heart rate conditioning in the rabbit. *Physiology Behavior*, *23*(6), 1109.
- Kapp, B. S., Frysinger, R. C., Gallagher, M., & Applegate, C. D. (1979). Amygdala central nucleus lesions: Effect on heart rate conditioning in the rabbit. *Physiology Behavior*, *23*, 1109-1117.
- Kapur, S., Zipursky, R. B. & Remington, G. (1999) Clinical and theoretical implications of 5-HT₂ and D₂ receptor occupancy of clozapine, risperidone, and olanzapine in schizophrenia. *American Journal of Psychiatry*, *156*, 286-293.
- Katona, C. L. E. (1999). Depression in old age. *Reviews in Clinical Gerontology*, *9*(4), 343-361.
- Kim, J.J., & Fanselow, M.S. (1992). Modality-specific retrograde amnesia of fear. *Science*, *256*, 675-677.

- Keefe, R. S., Sweeney, J. A., Gu, H., Hamer, R. M., Perkins, D. O., McEvoy, J. P. & Lieberman, J. A. (2007) Effects of olanzapine, quetiapine, and risperidone on neurocognitive function in early psychosis: a randomized, double-blind 52-week comparison. *American Journal of Psychiatry*, *164*, 1061-1071.
- Kodama, M., Fujioka, T. & Duman, R. S. (2004) Chronic olanzapine or fluoxetine administration increases cell proliferation in hippocampus and prefrontal cortex of adult rat. *Biological Psychiatry*, *56*, 570-580.
- Koh, E. T, & Ricardo, J. A. (1978). Afferents and efferents of the parabrachial region in the rat: Evidence for parallel ascending gustatory versus viseroceptive systems arising from the nucleus of the solitary tract. *Anatomical Record*, *190*, 449.
- Koliatsos, V. E., Price, D. L., Gouras, G. K., Cayouette, M. H., Burton, L. E., & Winslow, J. W. (1994). Highly selective effects of nerve growth factor, brain-derived neurotrophic factor, and neurotrophin-3 on intact and injured basal forebrain magnocellular neurons. *Journal of Comparative Neurology*, *343*, 247-262.
- Küçük, A., Gölgeli, A., Saraymen, R., & Koç, N. (2008). *Effects of age and anxiety on learning and memory*. *Brain Research*, *195*, 147-152.
- Kung, H. C., Hoyert, D. L., Xu, J., & Murphy, S. L. (2008). Deaths: Final data for 2005. *National Vital Statistic Report*, *56*, 1-120.
- Lang, P. J., Davis, M., & Ohman, A. (2000). Fear and anxiety: Animal models and human cognitive psychophysiology. *Journal of Affective Disorders*, *61*(3), 137-159.
- Lanzenberger, R. R., Mitterhauser, M., Spindelegger, C., Wadsak, W., Klein, N., Mien, L., et al. (2007). Reduced serotonin-1A receptor binding in social anxiety disorder. *Biological Psychiatry*, *61*, 1081-1089.
- Lara, J., Kusano, K., House, S., & Gainer, H. (2003). Interactions of cyclic adenosine monophosphate, brain-derived neurotrophic factor, and glial cell line-derived neurotrophic factor treatment on the survival and growth of postnatal mesencephalic dopamine neurons in vitro. *Experimental Neurology*, *180*, 32-45.
- Lazarov, O., Robinson, J., Tang, Y. P., Hairston, I. S., Korade-Mirnic, Z., Lee, V. M., et al. (2005). Environmental enrichment reduces Abeta levels and amyloid deposition in transgenic mice. *Cell*, *120*, 701-713.

- LeDoux, J. E. (2000). Emotion circuits in the brain. *Annual Review of Neuroscience*, 23, 155-184.
- LeDoux, J. E., Cicchetti, P., Xagoraris, A., & Romanski, L. R. (1990). The lateral amygdaloid nucleus: Sensory interface of the amygdala in fear conditioning. *The Journal of Neuroscience*, 10, 1062-1069.
- LeDoux, J. E., Farb, C., & Ruggiero, D. A. (1990). Topographic organization of neurons in the acoustic thalamus that project to the amygdala. *The Journal of Neuroscience*, 10, 1043-1054.
- LeDoux, J. E., Iwata, J., Cicchetti, P., & Reis, D. J. (1988). Different projections of the central amygdaloid nucleus mediate autonomic and behavioral correlates of conditioned fear. *The Journal of Neuroscience*, 8, 17-29.
- LeDoux, J. E., Sakaguchi, A., & Reis, D. J. (1984). Subcortical efferent projections of the medial geniculate nucleus mediate emotional responses conditioned to acoustic stimuli. *The Journal of Neuroscience*, 4, 683-698.
- Lee, K., Lee, S. H., Kim, H., Song, J. S., Yang, S. D., Paik, S. G., et al. (2004). Progressive cognitive impairment and anxiety induction in the absence of plaque deposition in C 57 BL/6 inbred mice expressing transgenic amyloid precursor protein. *Journal of Neuroscience Research*, 76, 572-580.
- Lee, Y., López, D. E., Meloni, E. G., & Davis, M. (1996). A primary acoustic startle pathway: Obligatory role of cochlear root neurons and the nucleus reticularis pontis caudalis. *The Journal of Neuroscience*, 16, 3775-3789.
- Lewis, J., McGowan, E., Rockwood, J., Melrose, H., Nacharaju, P., Van Slegtenhorst, M., et al. (2000). Neurofibrillary tangles, amyotrophy and progressive motor disturbance in mice expressing mutant (P301L) tau protein. *Nature Genetics*, 25, 402-40. Erratum in: *Nature Genetics*, 26,127.
- Li, R., Lindholm, K., Yang, L. B., Yue, X., Citron, M., Yan, R., et al. (2004) Amyloid beta peptide load is correlated with increased beta-secretase activity in sporadic Alzheimer's disease patients. *Proceedings of the National Academy of Sciences, USA*, 101, 3632-3637.
- Lidov, H. G., & Molliver, M. E. (1982). An immunohistochemical study of serotonin neuron development in the rat: Ascending pathways and terminal fields. *Brain Research Bulletin*, 8, 389-430.

- Lieberman, J. A., Tollefson, G. D., Charles, C., Zipursky, R., Sharma, T., Kahn, R. S., Keefe, R. S., Green, A. I., Gur, R. E., McEvoy, J., Perkins, D., Hamer, R. M., Gu, H., & Tohen, M., HGDH Study Group (2005) Antipsychotic drug effects on brain morphology in first-episode psychosis. *Archives of General of Psychiatry*, *62*, 361-370.
- Lie, D. C., Song, H., Colamarino, S. A., Ming, G. L., & Gage, F. H. (2004) Neurogenesis in the adult brain: new strategies for central nervous system diseases. *Annual Review of Pharmacology Toxicology*, *44*, 399-421.
- Liu, Y., Yoo, M., Savonenko, A., Stirling, W., Price, D. L., Borchelt, D. R., et al. (2008). Amyloid pathology is associated with progressive monoaminergic neurodegeneration in a transgenic mouse model of Alzheimer's disease. *The Journal of Neuroscience*, *28*(51), 13805.
- Livesey, P.J. (1986). *Learning and emotion: A biological synthesis*. Hillsdale, NJ:Lawrence Erlbaum.
- Logsdon, R. G., Gibbons, L. E., McCurry, S. M., & Teri, L. (2002). Assessing quality of life in older adults with cognitive impairment. *Psychosomatic Medicine*, *64*, 510-519.
- Luo, C., Xu, H., Li, X. M. (2005). Quetiapine reverses the suppression of hippocampal neurogenesis caused by repeated restraint stress. *Brain Research*, *1063*, 32-39.
- Lyketsos, C. G., Breitner, J. C., & Rabins, P. V. (2001). An evidence-based proposal for the classification of neuropsychiatric disturbance in Alzheimer's disease. *International Journal of Geriatric Psychiatry*, *16*, 1037-1042.
- Lyketsos, C. G., Sheppard, J. M., Steele, C. D., Kopunek, S., Steinberg, M., Baker, A. S., et al. (2000). Randomized, placebo-controlled, double-blind clinical trial of sertraline in the treatment of depression complicating alzheimer's disease: Initial results from the depression in alzheimer's disease study. *The American Journal of Psychiatry*, *157*(1), 1686-1689.
- MacDonald, A. J., & Jackson, T. R. (1987). Amygdaloid connections with posterior insular and temporal cortical areas in the rat. *Journal of Comparative Neurology*, *262*(1), 59-77.
- MacLean, P. D. (1949). Psychosomatic disease and the visceral brain recent developments bearing on the papez theory of emotion. *Psychosomatic Medicine*, *11*, 338-353.
- Madhusoodanan, S., Shah, P., Brenner, R., Gupta, S. (2007) Pharmacological treatment of the psychosis of Alzheimer's disease: what is the best approach? *CNS Drugs*, *21*, 101-115.

- Mamounas, L. A., Altar, C. A., Blue, M. E., Kaplan, D. R., Tessarollo, L., & Lyons, W. E. (2000). BDNF promotes the regenerative sprouting, but not survival, of injured serotonergic axons in the adult rat brain. *Journal of Neuroscience*, *20*, 771-782.
- Maren, S., Aharonov, G., & Fanselow, M. S. (1996). Retrograde abolition of conditional fear after excitotoxic lesions in the basolateral amygdala of rats: Absence of a temporal gradient. *Behavioral Neuroscience*, *110*, 718-726.
- Maren, S., & Fanselow, M.S. (1996). The amygdala and fear conditioning: Has the nut been cracked? *Neuron*, *16*, 237-240.
- Marin, R. S. (1991). Apathy: A neuropsychiatric syndrome. *Journal of Neuropsychiatry and Clinical Neurosciences*, *3*, 243-254.
- Martin, G. R., & Humphrey, P. P. (1994). Receptors for 5-hydroxytryptamine: Current perspectives on classification and nomenclature. *Neuropharmacology*, *33*, 261-273.
- Mathews, A., & MacLeod, C. (1994). Cognitive approaches to emotion and emotional disorders. *Annual Review of Psychology*, *45*, 25-50.
- Mattson, M. P. (2004). Pathways towards and away from Alzheimer's disease. *Nature*, *430*(7000), 631-639.
- Matsuoka, Y., Picciano, M., Malester, B., LaFrancois, J., Zehr, C., Daeschner, J. M., et al. (2001). Inflammatory responses to amyloidosis in a transgenic mouse model of alzheimer's disease. *American Journal Pathology*, *158*, 1345-1354.
- McCurry, S. M., Gibbons, L. E., Logsdon, R. G., & Teri, L. (2004). Anxiety and nighttime behavioral disturbances. awakenings in patients with alzheimer's disease. *Journal of Gerontological Nursing*, *30*, 12-20.
- McDonald, A. J., & Jackson, T. R. (1987). Amygdaloid connections with posterior insular and temporal cortical areas in the rat. *Journal of Comparative Neurology*, *262*(1), 59.
- McNally, R. J. (1998). Abnormalities in anxiety implications for cognitive neuroscience. *Cognition Emotion*, *12*, 479-495.
- McNaughton, N. (1997). Cognitive Dysfunction Resulting from Hippocampal Hyperactivity—A Possible Cause of Anxiety Disorder? *Pharmacology, Biochemistry and Behavior*, *54*, 603-611.

- Mendez, M. F., McMurtray, A., Chen, A. K., Shapira, J. S., Mishkin, F., & Miller, B. L. (2006). Functional neuroimaging and presenting psychiatric features in frontotemporal dementia. *Journal of Neurology, Neurosurgery and Psychiatry*, 77, 4-7.
- Michalski, B., & Fahnstock, M. (2003). Pro-brain-derived neurotrophic factor is decreased in parietal cortex in Alzheimer's disease. *Brain Research. Molecular Brain Research*, 111, 148 – 154.
- Ming, G. L., & Song, H. (2005) Adult neurogenesis in the mammalian central nervous system. *Annual Review of Neuroscience*, 28, 223-250.
- Mintzer, J. E., Brawman-Mintzer, O., Mirski, D.F., & Barkin, K. (2000). Behavioral and psychological symptoms of dementia (BPSD): A clinical and research update-phenomenology-anxiety in the behavioral and psychological symptoms of dementia. *International Psychogeriatrics*, 12, 139-142.
- Moechars, D., Dewachter, I., Lorent, K., Reversé, D., Baekelandt, V., Naidu, A., et al. (1999). Early phenotypic changes in transgenic mice that overexpress different mutants of amyloid precursor protein in brain. *Journal of Biological Chemistry*, 274, 6483-6492.
- Monfils, M. H., Cowansage, K. K., & LeDoux, J. E. (2007). Brain-derived neurotrophic factor: Linking fear learning to memory consolidation. *Molecular Pharmacology*, 72, 235-237.
- Morgan, M. A., Romanski, L. M., & LeDoux, J. E. (1993). Extinction of emotional learning: Contribution of medial prefrontal cortex. *Neuroscience Letters*, 163, 109-113.
- Morris, R (1984) Developments of a water-maze procedure for studying spatial learning in the rat. *Journal of Neuroscience Methods*, 11, 47-60.
- Murer, M.G., Boissiere, F., Yan, Q., Hunot, S., Villares, J., Faucheux, B., et al. (1999). An immunohistochemical study of the distribution of brain-derived neurotrophic factor in the adult human brain, with particular reference to Alzheimer's disease. *Neuroscience*, 88, 1015– 1032.
- Murphy, D. L. (1990). Neuropsychiatric disorders and the multiple human brain serotonin receptor subtypes and subsystems. *Neuropsychopharmacology*, 3, 457-471.
- Nacmias, B., Tedde, A., Forleo, P., Piacentini, S., Guarnieri, B.M., Bartoli, A., et al. (2001). Association between 5-HT_{2A} receptor polymorphism and psychotic symptoms in Alzheimer's disease. *Biological Psychiatry* 50, 472–475.

- Nash, J. R., Sargent, P. A., Rabiner, E. A., Hood, S. D., Argyropoulos, S. V., Potokar, J. P., et al. (2008). Serotonin 5-HT_{1A} receptor binding in people with panic disorder: Positron emission tomography study. *The British Journal of Psychiatry*, *193*, 229-234.
- Nunes-de-Souza, R. L., Canto-de-Souza, A., & Rodgers, R. J. (2002). Effects of intra-hippocampal infusion of WAY-100635 on plus-maze behavior in mice. influence of site of injection and prior test experience. *Brain Research*, *927*, 87-96.
- Oddo, S., Caccamo, A., Kitazawa, M., Tseng, B. P., LaFerla, F. M. (2003). Amyloid deposition precedes tangle formation in a triple transgenic model of Alzheimer's disease. *Neurobiology of Aging*, *24*, 1063-1070.
- Ognibene, E., Middei, S., Daniele, S., Adriani, W., Ghirardi, O., Caprioli, A., et al. (2005). Aspects of spatial memory and behavioral disinhibition in Tg2576 transgenic mice as a model of Alzheimer's disease. *Behavioural Brain Research*, *156*, 225-232.
- Ohl, F., Arndt, S. S., & van der Staay, F. J. (2008). Pathological anxiety in animals. *The Veterinary Journal*, *175*, 18-26.
- Ohl, F., Roedel, A., Binder, E., & Holsboer, F., (2003). Impact of high and low anxiety on cognitive performance in a modified hole board test in C57BL/6 and DBA/2 mice. *The European Journal of Neuroscience*, *17*(1), 128-136.
- Orrell, M., & Bebbington, P. (1996). Psychosocial stress and anxiety in senile dementia. *Journal of Affective Disorders*, *39*, 165-173.
- Ortiz, F., Fitten, L. J., Cummings, J. L., Hwang, S., & Fonseca, M., (2006). Neuropsychiatric and behavioral symptoms in a community sample of hispanics with alzheimer's disease. *American Journal of Alzheimer's Disease and Other Dementias*, *21*, 263-273.
- Ou, L. C., & Gean, P. W. (2007). Transcriptional regulation of brain-derived neurotrophic factor in the amygdala during consolidation of fear memory. *Molecular Pharmacology*, *72*, 350-358.
- Ownby, R. L., Harwood, D. G., Barker, W. W., & Duara, R. (2000). Predictors of anxiety in patients with Alzheimer's disease. *Depression and Anxiety*, *11*, 38-42.
- Oyama, F., Sawamura, N., Kobayashi, K., Morishima-Kawashima, M., Kuramochi, T., Ito, M., et al. (1998). Mutant presenilin 2 transgenic mouse: effect on an age-dependent increase of amyloid beta-protein 42 in the brain. *Journal of Neurochemistry*, *71*, 313-322.

- Pae, C. U., Lim, H. K., Peindl, K., Ajwani, N., Serretti, A., Patkar, A. A., & Lee, C. (2008) The atypical antipsychotics olanzapine and risperidone in the treatment of posttraumatic stress disorder: a meta-analysis of randomized, double-blind, placebo-controlled clinical trials. *International Clinical Psychopharmacology*, *23*, 1-8.
- Papez, J. W. (1937). A proposed mechanism of emotion. *Archives of Neurology and Psychiatry*, *79*, 237-244.
- Parent, M. B., West, M., & McGaugh, J. L. (1994). Memory of rats with amygdala lesions induced 30 days after footshock-motivated escape training reflects degree of original training. *Behavioral Neuroscience*, *108*, 1080-1087.
- Parikh, V., Evans, D. R., Khan, M. M., & Mahadik, S. P. (2003) Nerve growth factor in never-medicated first-episode psychotic and medicated chronic schizophrenic patients: possible implications for treatment outcome. *Schizophrenia Research*, *60*, 117-123.
- Park, S. W., Lee, S. K., Kim, J. M., Yoon, J. S., & Kim, Y. H. (2006). Effects of quetiapine on the brain-derived neurotrophic factor expression in the hippocampus and neocortex of rats. *Neuroscience Letters*, *402*, 25-29.
- Parks, C. L., Robinson, P. S., Sibille, E., Shenk, T., & Toth, M. (1998). Increased anxiety of mice lacking the serotonin1A receptor. *Proceedings of the National Academy of Sciences of the United States of America*, *95*, 10734-10739.
- Paulsen, J. S., Ready, R. E., Hamilton, J. M., Mega, M. S., & Cummings, J. L. (2001). Neuropsychiatric aspects of huntington's disease. *Journal of Neurology, Neurosurgery and Psychiatry*, *71*, 310-314.
- Phillips, H.S., Hains, J.M., Armanini, M., Laramée, G.R., Johnson, S.A., & Winslow, J.W. (1991). BDNF mRNA is decreased in the hippocampus of individuals with Alzheimer's disease. *Neuron*, *7*, 695 – 702.
- Phillips, R.G., & LeDoux, J.E. (1992). Differential contribution of amygdala and hippocampus to cued and contextual fear conditioning. *Behavioral Neuroscience*, *106*, 274-285.
- Pinheiro, S. H., Zangrossi, H., Del-Ben, C. M., & Graeff, F. G. (2007). Elevated mazes as animal models of anxiety: Effects of serotonergic agents. *Anais Da Academia Brasileira De Ciências*, *79*, 71-85.

- Pitkanen, A., Stefannacci, L., Farb, C. F., Go, G., LeDoux, J. E., & Amaral, D. G. (1995). Intrinsic connections of the rat amygdaloid complex: Projections originating in the lateral nucleus. *Journal of Comparative Neurology*, *356*, 288-310.
- Pliakas, A. M., Carlson, R. R., Neve, R. L., Konradi, C., Nestler, E. J., & Carlezon, W. A. (2001). Altered responsiveness to cocaine and increased immobility in the forced swim test associated with elevated cAMP response element-binding protein expression in nucleus accumbens. *The Journal of Neuroscience*, *21*, 7397-7403.
- Plomin, R., Owen, M. J., & McGuffin, P. (1994). The genetic basis of complex human behaviors. *Science*, *264*, 1733-1739.
- Pollack, M. H., Worthington, J. J. 3rd, Otto, M. W., Maki, K. M., Smoller, J. W., Manfro, G. G., Rudolph, R. & Rosenbaum, J. F. (1996). Venlafaxine for panic disorder: results from a double-blind, placebo-controlled study. *Psychopharmacology Bulletin*, *32*, 667-670.
- Poltronieri, S. C., Zangrossi, H., & de Barros Viana, M. (2003). Antipanic-like effect of serotonin reuptake inhibitors in the elevated T-maze. *Behavioural Brain Research*, *147*, 185-192.
- Pudovkina, O. L., Cremers, T. I., Westerink, B. H. (2002) The interaction between the locus coeruleus and dorsal raphe nucleus studied with dual-probe microdialysis. *European Journal of Pharmacology*, *445*(1-2), 37-42.
- Pugh, P., Richardson, J. C., Bate, S. T., Upton, N., & Sunter, D. (2007). Non-cognitive behaviours in an APP/PS1 transgenic model of Alzheimer's disease. *Behavioural Brain Research*, *178*, 18-28.
- Purdon, S. E., Malla, A., Labelle, A. & Lit, W. (2001) Neuropsychological change in patients with schizophrenia after treatment with quetiapine or haloperidol. *Journal of Psychiatry and Neuroscience*, *26*, 137-149.
- Puoliväli, J., Wang, J., Heikkinen, T., Heikkilä, M., Tapiola, T., Van Groen, T. et al. (2002). Hippocampal Abeta42 levels correlate with spatial memory deficit in APP and PS1 double transgenic mice. *Neurobiology of Disease*. *9*, 339-347.
- Quirk, G. J., Reppas, C., & LeDoux, J. E. (1995). Fear conditioning enhances short-latency auditory responses of lateral amygdala neurons: Parallel recordings in the freely behaving rat. *Neuron*, *15*, 1029-1039.

- Qing, H., Xu, H., Wei, Z., Gibson, K., Li, X. M. (2003) The ability of atypical antipsychotic drugs vs. haloperidol to protect PC12 cells against MPP+-induced apoptosis. *European Journal of Neuroscience*, *17*, 1563-1570.
- Rabiner, E. A., Messa, C., Sargent, P. A., Husted-Kjaer, K., Montgomery, A., Lawrence, A. D., et al. (2002). A database of [(11)C]WAY-100635 binding to 5-HT(1A) receptors in normal male volunteers: normative data and relationship to methodological, demographic, physiological, and behavioral variables. *Neuroimage*, *15*, 620-632.
- Rajadhyaksha, M., Gonzalez, S., Zavislan, J. M., Anderson, R. R., & Webb, R. H. (1999). In vivo confocal scanning laser microscopy of human skin II: Advances in instrumentation and comparison with histology 1. *The Journal of Investigative Dermatology*, *113*, 293-303.
- Rattiner, L. M., Davis, M., French, C. T., & Ressler, K. J. (2004a). Brain-derived neurotrophic factor and tyrosine kinase receptor B involvement in amygdala-dependent fear conditioning. *Journal of Neuroscience*, *24*, 4796-4806.
- Rattiner, L. M., Davis, M., & Ressler, K. J. (2004b). Differential regulation of brain derived neurotrophic factor transcripts during the consolidation of fear learning. *Learning and Memory*, *11*, 727-731.
- Reisberg, B., Auer, S. R., Monteiro, I. M. (2005). Behavioral pathology in Alzheimer's disease (BEHAVE-AD) rating scale. *International Psychogeriatrics*, *8*, 301.
- Ressler, K. J., & Nemeroff, C. B. (2000). Role of serotonergic and noradrenergic systems in the pathophysiology of depression and anxiety disorders. *Depression and Anxiety*, *12*, 2-19.
- Rezayat, M., Roohbakhsh A., Zarrindast, M. R., Massoudi, R., & Djahanguiri, B. (2005). Cholecystokinin and GABA interaction in the dorsal hippocampus of rats in the elevated plus-maze test of anxiety. *Physiology Behavior*, *84*, 775-782.
- Richardson, J. S. (1973). The amygdala: historical and functional analysis. *Acta Neurobiologiae Experimentalis (Warsaw)*, *33*, 623-648.
- Richardson, J. S. (1974). Basic concepts of psychopharmacological research as applied to the psychopharmacological analysis of the amygdala. *Acta Neurobiologiae Experimentalis (Warsaw)*, *34*, 543-562.
- Richardson, J. S. (1993). On the functions of monoamine oxidase, the emotions, and adaptation to stress. *International Journal of Neuroscience*, *70*, 75-84.

- Rioja, J., Santín, L. J., López-Barroso, D., Doña A., Ulzurrún E., Aguirre J. A. (2007). 5-HT_{1A} receptor activation counteracted the effect of acute immobilization of noradrenergic neurons in the rat locus coeruleus *Neuroscience Letters*, *412*(1), 84–88.
- Rocca, P., Marino, F., Montemagni, C., Perrone, D., & Bogetto, F. (2007). Risperidone, olanzapine and quetiapine in the treatment of behavioral and psychological symptoms in patients with Alzheimer's disease: Preliminary findings from a naturalistic, retrospective study. *Psychiatry and Clinical Neurosciences*, *61*, 622-629.
- Romanski, L. M., & LeDoux, J. E. (1993). Information cascade from primary auditory cortex to the amygdala: Corticocortical and corticoamygdaloid projections of temporal cortex in the rat. *Cerebral Cortex*, *3*, 515-532.
- Roosendaal, B., Koolhaas, J. M., & Bohus, B. (1990). Differential effect of lesioning of the central amygdala on the bradycardiac and behavioral response of the rat in relation to conditioned social and solitary stress. *Behavioural Brain Research*, *41*, 39-48.
- Rosen, J. B., & Davis, M. (1988a). Enhancement of acoustic startle by electrical stimulation of the amygdala. *Behavioral Neuroscience*, *102*, 195-202.
- Rosen, J. B., & Davis, M. (1988b). Temporal characteristics of enhancement of startle by stimulation of the amygdala. *Physiology and Behavior*, *44*, 117-123.
- Rosen, J. B., & Schulkin, J. (1998). From normal fear to pathological anxiety. *Psychological Review*, *105*, 325-350.
- Roy, N. S., Wang, S., Jiang, L., Kang, J., Benraiss, A., Harrison-Restelli, C., et al. (2000) In vitro neurogenesis by progenitor cells isolated from the adult human hippocampus. *Nature Medicine*, *6*, 271-277.
- Sananes, C. B., & Davis, M. (1992). N-methyl-D-aspartate lesions of the lateral and basolateral nuclei of the amygdala block fear-potentiated startle and shock sensitization of startle. *Behavioral Neuroscience*, *106*, 72-80.
- Sanson, L. T., & Carobrez, A. P. (1999). Long-lasting inhibitory avoidance acquisition in rats submitted to the elevated T-maze model of anxiety. *Behavioural Brain Research*, *101*, 59-64.
- Savaskan, E., Schnitzler, C., Schröder, C., Cajochen, C., Müller-Spahn, F., & Wirz-Justice, A. (2006). Treatment of behavioural, cognitive and circadian rest-activity cycle disturbances

- in Alzheimer's disease: Haloperidol vs. quetiapine. *The International Journal of Neuropsychopharmacology*, 5, 507-516.
- Scharre, D. W., & Chang, S. I. (2002). Cognitive and behavioral effects of quetiapine in Alzheimer disease patients. *Alzheimer Disease and Associated Disorders*, 16, 128-130.
- Schneider, L. S., Tariot, P. N., Dagerman, K. S., Davis, S. M., Hsiao, J. K., Ismail, M. S., et al. (2006). Effectiveness of atypical antipsychotic drugs in patients with Alzheimer's disease. *The New England Journal of Medicine*, 355, 1525-1538.
- Sclan, S. G., Saillon, A., Franssen, E., & Hugonot-Diener, L. (1996). The behavior pathology in Alzheimer's disease rating scale (BEHAVE-AD): Reliability and analysis of symptom category scores. *International Journal of Geriatric Psychiatry*, 11, 819-830.
- Seeman, P., & Tallerico, T. (1999) Rapid release of antipsychotic drugs from dopamine D2 receptors: an explanation for low receptor occupancy and early clinical relapse upon withdrawal of clozapine or quetiapine. *American Journal of Psychiatry*, 156, 876-884.
- Seignourel, P. J., Kunik, M. E., Snow, L., Wilson, N., & Stanley, M. (2008). Anxiety in dementia: A critical review. *Clinical Psychology Review*, 28, 1071-1082
- Selkoe, D. J., & Podlisny, M. B. (2002). Deciphering the genetic basis of Alzheimer's disease. *Annual Review of Genomics and Human Genetics*, 3, 67-99.
- Skoog, I., Nilsson, L., Palmertz, B., Andreasson, L. A., & Svanborg, A. (1993). A population-based study of dementia in 85-year-olds. *The New England Journal of Medicine*, 328(3), 153.
- Sprouse, J. S., & Aghajanian, G. K. (1988). Responses of hippocampal pyramidal cells to putative serotonin 5-HT1A and 5-HT1B agonists: A comparative study with dorsal raphe neurons. *Neuropharmacology*, 27, 707-715.
- Starkstein, S. E., Jorge, R., Petracca, G., & Robinson, R. G. (2007). The construct of generalized anxiety disorder in alzheimer disease. *The American Journal of Geriatric Psychiatry*, 15(1), 42-49.
- Stefanacci, L., Farb, C. R., Pitkänen, A., Go, G., LeDoux, J. E., & Amaral, D. G. (1992). Projections from the lateral nucleus to the basal nucleus of the amygdala: A light and electron microscopic PHA-L study in the rat. *Journal of Comparative Neurology*, 323, 2-17.

- Storey, E., & Cappai, R. (1999). The amyloid precursor protein of Alzheimer's disease and the Abeta peptide. *Neuropathology and Applied Neurobiology*, 25, 81-97.
- Strauss, C. V. A., Maissonette, S. S., Coimbra, N. C., & Zangrossi, H. (2003). Effects of N-methyl-D-aspartate-induced amygdala lesion in rats submitted to the elevated T-maze test of anxiety. *Physiology Behavior*, 78, 157-163.
- Street, J. S., Clark, W. S., Gannon, K. S., Cummings, J. L., Bymaster, F. P., & Tamura, R. N. (2000). Olanzapine treatment of psychotic and behavioral symptoms in patients with alzheimer disease in nursing care facilities: A double-blind, randomized, placebo-controlled trial. *Archives of General Psychiatry*, 57, 968-976.
- Sturchler-Pierrat, C., Abramowski, D., Duke, M., Wiederhold, K. H., Mistl, C., Rothacher, S., et al. (1997). Two amyloid precursor protein transgenic mouse models with Alzheimer disease-like pathology. *Proceedings of the National Academy of Sciences, USA*, 94, 13287-13292.
- Suh, Y., & Checler, F. (2002). Amyloid precursor protein, presenilins, and alpha -synuclein: Molecular pathogenesis and pharmacological applications in alzheimer's disease. *Pharmacology Review*, 54, 469-525.
- Sultzer, D. L. (1996). Behavioral syndrome in dementia: Neuroimaging insights. *Seminars in Clinical Neuropsychiatry*, 1, 261-271.
- Suzuki, W. A. (1996). The anatomy, physiology and functions of the perirhinal cortex. *Current Opinion in Neurobiology*, 6, 179-186.
- Szapacs, M.E., Numis, A.L. & Andrews, A.M. (2004). Late onset loss of hippocampal 5-HT and NE is accompanied by increases in BDNF protein expression in mice co-expressing mutant APP and PS1. *Neurobiology of Disease*, 16, 572 – 580.
- Tariot, P. N., Profenno, L. A., & Ismail, M. S. (2004). Efficacy of atypical antipsychotics in elderly patients with dementia. *The Journal of Clinical Psychiatry*, 65, 11-15.
- Tanzi, R. E. & Beltram, L. (2005). Twenty years of the Alzheimer's disease amyloid hypothesis: a genetic perspective. *Cell*, 120, 545-555.
- Teixeira, R. C., Zangrossi, H., & Graeff, F. G. (2000). Behavioral effects of acute and chronic imipramine in the elevated T-maze model of anxiety. *Pharmacology Biochemistry and Behavior*, 65, 571-576.

- Terwilliger, R. Z., Beitner-Johnson, D., Sevarino, K. A., Crain, S. M., & Nestler, E. J. (1991). A general role for adaptations in G-proteins and the cyclic AMP system in mediating the chronic actions of morphine and cocaine on neuronal function. *Brain Research*, *548*, 100-110.
- Tomaz, C., Dickinson-Anson, H., & McGaugh, J. L. (1991). Amygdala lesions block the amnesic effects of diazepam. *Brain Research*, *568*, 85-91.
- Treit, D., & Menard, J. (1997). Dissociations among the anxiolytic effects of septal, hippocampal, and amygdaloid lesions. *Behavioral Neuroscience*, *111*, 653-658.
- Treit, D., Menard, J., & Royan, C. (1993). Anxiogenic stimuli in the elevated plus-maze. *Pharmacology, Biochemistry and Behavior*, *44*, 463-469.
- Trivedi, M. A., & Coover, G. D. (2004). Lesions of the ventral hippocampus, but not the dorsal hippocampus, impair conditioned fear expression and inhibitory avoidance on the elevated T-maze. *Neurobiology of Learning and Memory*, *81*, 172-184.
- Turner, B. J., & Herkenham, M. (1991). The architecture and some of the interconnections in the rat: A test of the amygdala's role in sensory processing. *Journal of Comparative Neurology*, *227*, 295-325.
- Upton, A. L., Salichon, N., Lebrand, C., Ravary, A., Blakely, R., Seif, I., et al. (1999). Excess of serotonin (5-HT) alters the segregation of ipsilateral and contralateral retinal projections in monoamine oxidase A knock-out mice: Possible role of 5-HT uptake in retinal ganglion cells during development. *The Journal of Neuroscience*, *19*, 7007-7024.
- Vaidya, V., & Duman, R.S. (2001). Depression-emerging insights from neurobiology. *British Medical Bulletin*, *57*, 61-79.
- Van Gassen, G., & Annaert, W. (2003) Amyloid, presenilins, and alzheimer's disease. *Neuroscientist*, *9*, 117-126.
- Veening, J. G. (1978). Subcortical afferents of the amygdaloid complex in the rat: An HRP study. *Neuroscience Letters*, *8*, 197-202.
- Velligan, D. I., Newcomer, J., Pultz, J., Csernansky, J., Hoff, A. L., Mahurin, R., & Miller, A. L. (2002) Does cognitive function improve with quetiapine in comparison to haloperidol? *Schizophrenia Research*, *53*, 239-248.
- Velligan, D. I., Prihoda, T. J., Sui, D., Ritch, J. L., Maples, N., & Miller, A. L. (2003) The effectiveness of quetiapine versus conventional antipsychotics in improving cognitive and

- functional outcomes in standard treatment settings. *Journal of Clinical Psychiatry*, *64*, 524-531.
- Verret, L., Jankowsky, J. L., Xu, G. M., Borchelt, D. R., & Rampon, C. (2007) Alzheimer's-type amyloidosis in transgenic mice impairs survival of newborn neurons derived from adult hippocampal neurogenesis. *Journal of Neuroscience*, *27*, 6771-6780.
- Viana, M. B., Tomaz, C., & Graeff, F. G. (1994). The elevated T-maze: A new animal model of anxiety and memory. *Pharmacology, Biochemistry and Behavior*, *49*, 549-554.
- Viana, M. d. B., Zangrossi, H., & Onusic, G. M. (2008). 5-HT_{1A} receptors of the lateral septum regulate inhibitory avoidance but not escape behavior in rats. *Pharmacology, Biochemistry and Behavior*, *89*, 360-366.
- Waddington, J. L., O'Callaghan, E., Buckley, P., Larkin, C., Redmond, O., Stack, J., et al. (1991) The age dependencies of MRI abnormalities in schizophrenia suggest early ventricular enlargement but later prominence of cortical atrophy. *Schizophrenia Research*, *5*, 188-189.
- Wakade, C. G., Mahadik, S. P., Waller, J. L., & Chiu, F. C. (2002) Atypical neuroleptics stimulate neurogenesis in adult rat brain. *Journal of Neuroscience Research*, *69*, 72-79.
- Wallace, D. M., Magnuson, D. J., & Gray, T. S. (1992). Organization of amygdaloid projections to brainstem dopaminergic, noradrenergic, and adrenergic cell groups in the rat. *Brain Research Bulletin*, *28*, 447-454.
- Wallace, T.L., Stellitano, K.E., Neve, R.L., & Duman, R.S. (2004). Effects of cyclic adenosine monophosphate response element binding protein overexpression in the basolateral amygdala on behavioral models of depression and anxiety. *Biological Psychiatry*, *56*, 151-160.
- Wands, K., Merskey, Hachinski, V. C., Fisman, M., Fox, H., & Boniferno, M. (1990) A questionnaire investigation of anxiety and depression in early dementia. *Journal of the American Geriatrics Society*, *38*, 535-538.
- Wang, H., Xu, H., Dyck, L. E., & Li, X. M. (2005). Olanzapine and quetiapine protect PC12 cells from beta-amyloid peptide(25-35)-induced oxidative stress and the ensuing apoptosis. *Journal of Neuroscience Research*, *81*, 572-580.
- Wei, Z., Bai, O., Richardson, J. S., Mousseau, D. D., & Li, X. M. (2003) Olanzapine protects PC12 cells from oxidative stress induced by hydrogen peroxide. *Journal of Neuroscience Research*, *73*, 364-368.

- Wei, Z., Mousseau, D. D., Richardson, J. S., Dyck, L. E., & Li, X. (2003). Atypical antipsychotics attenuate neurotoxicity of beta-amyloid(25-35) by modulating bax and bcl-X(l/s) expression and localization. *Journal of Neuroscience Research*, *74*, 942-947.
- Wilquet, V., & De Strooper, B. (2004) Amyloid-beta precursor protein processing in neurodegeneration. *Current Opinion in Neurobiology*, *14*, 582-588.
- Wolfgang, S. A. (1999). Olanzapine in whole, not half, tablets for psychosis from Alzheimer's dementia. *American Journal of Health-System Pharmacy*, *56*, 2245-2246.
- Wong, A. H., & Van Tol, H. H. (2003) Schizophrenia: from phenomenology to neurobiology. *Neuroscience and Biobehavioral Reviews*, *27*, 269-306.
- Woods, B. T., Yurgelun-Todd, D., Benes, F. M., Frankenburg, F. R., Pope, H. G., Jr, & McSparren, J. (1990) Progressive ventricular enlargement in schizophrenia: comparison to bipolar affective disorder and correlation with clinical course. *Biological Psychiatry*, *27*, 341-352.
- Wragg, R. E., & Jeste, D. V. (1989). Overview of depression and psychosis in Alzheimer's disease. *The American Journal of Psychiatry*, *146*, 577-587.
- Xiao, L., Xu, H., Zhang, Y., Wei, Z., He, J., Jiang, W., et al. (2008). Quetiapine facilitates oligodendrocyte development and prevents mice from myelin breakdown and behavioral changes. *Molecular Psychiatry*, *13*, 697-708.
- Xu, H., Qing, H., Lu, W., Keegan, D., Richardson, J.S., Chlan Fourney J, et al. (2002). Quetiapine attenuates the immobilization stress-induced decrease of brain-derived neurotrophic factor expression in rat hippocampus. *Neuroscience Letters*, *321*, 65-68.
- Xu, H., Wang, H., Zhuang, L., Yan, B., Yu, Y., Wei, Z., et al. (2008). Demonstration of an oxidative stress mechanism of quetiapine: implications for the treatment of Alzheimer's disease. *FEBS Journal*, *275*, 3718-3728.
- Yamada, K., Iida, R., Miyamoto, Y., Saito, K., Sekikawa, K., Seishima, M., et al. (2000). Neurobehavioral alterations in mice with a targeted deletion of the tumor necrosis factor-alpha gene: Implications for emotional behavior. *Journal of Neuroimmunology*, *111*, 131-138.
- Yan, B., Bi, X., He, J., Zhang, Y., Thakur, S., & Xu, H., et al. (2007). Quetiapine attenuates spatial memory impairment and hippocampal neurodegeneration induced by bilateral common carotid artery occlusion in mice. *Life Sciences*, *81*, 353-361.

- Yan, B., He, J., Xu, H., Zhang, Y., Bi, X., & Thakur, S., et al. (2007). Quetiapine attenuates the depressive and anxiolytic-like behavioural changes induced by global cerebral ischemia in mice. *Behavioural Brain Research*, *182*, 36-41.
- Yan, W., Wilson, C. C., & Haring, J. H. (1997). 5-HT_{1a} receptors mediate the neurotrophic effect of serotonin on developing dentate granule cells. *Developmental Brain Research*, *98*, 185-190.
- Yang, L. B., Lindholm, K., Yan, R., Citron, M., Xia, W., Yang, X. L., et al. (2003). Elevated beta-secretase expression and enzymatic activity detected in sporadic alzheimer disease. *Nature Medicine*, *9*, 3-4.
- Yu, Y., He, J., Zhang, Y., Luo, H., Zhu, S., Yang, Y., et al. (in press). Increased hippocampal neurogenesis in the progressive stage of Alzheimer's disease phenotype in an APP/PS1 double transgenic mouse model. *Hippocampus*.
- Zangrossi, H., & Graeff, F. G. (1997). Behavioral validation of the elevated T-maze, a new animal model of anxiety. *Brain Research Bulletin*, *44*, 1-5.